

Manual on the production and use of live food for aquaculture

FAO
FISHERIES
TECHNICAL
PAPER

361

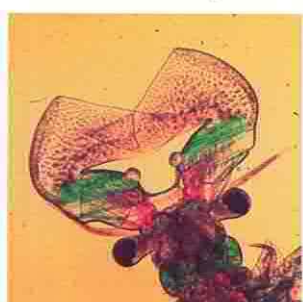

Food
and
Agriculture
Organization
of
the
United
Nations



Manual on the production and use of live food for aquaculture

FAO
FISHERIES
TECHNICAL
PAPER

361

Edited by

Patrick Lavens and Patrick Sorgeloos

Laboratory of Aquaculture and Artemia Reference Center

University of Ghent

Ghent, Belgium

Food
and
Agriculture
Organization
of
the
United
Nations



Rome, 1996

The designations employed and the presentation of material in this publication do not imply the expression of any opinion whatsoever on the part of the Food and Agriculture Organization of the United Nations concerning the legal status of any country, territory, city or area or of its authorities, or concerning the delimitation of its frontiers or boundaries.

M-44
ISBN 92-5-103934-8

All rights reserved. No part of this publication may be reproduced, stored in a retrieval system, or transmitted in any form or by any means, electronic, mechanical, photocopying or otherwise, without the prior permission of the copyright owner. Applications for such permission, with a statement of the purpose and extent of the reproduction, should be addressed to the Director, Information Division, Food and Agriculture Organization of the United Nations, Viale delle Terme di Caracalla, 00100 Rome, Italy.

© **FAO 1996**

PREPARATION OF THIS DOCUMENT

The success of any farming operation for fish and shellfish depends upon the availability of a ready supply of larvae or seed for on-growing to market size. However, for many fish and shellfish species (i.e. carps, marine finfish, crustaceans, bivalves etc.) this has only been possible in recent years through the development and use of a succession of live food organisms as feed for the developing larvae. The aim of the present manual was therefore to review and summarise the latest developments concerning the production and use of the major live food organisms currently employed in larviculture worldwide.

This document has been prepared within the framework of the aquaculture nutrition and feed development activities of Dr. A.G.J. Tacon, Fishery Resources Officer, Inland Water Resources and Aquaculture Service, FAO Fishery Resources Division, to help meet the needs of aquaculture workers of Member Countries for the synthesis of information in the field of aquaculture nutrition.

The editors would like to thank James de Caluwe, Rudi Bijmens, Magda Vanhooren and March Verschraeghen for their assistance with the layout of the manual.

Lavens, P; Sorgeloos, P. (eds.)
Manual on the production and use of live food for aquaculture
FAO Fisheries Technical Paper. No. 361. Rome, FAO. 1996. 295p.

ABSTRACT

The cultivation of fish and shellfish larvae under controlled hatchery conditions requires not only the development of specific culture techniques, but in most cases also the production and use of live food organisms as feed for the developing larvae. The present manual describes the major production techniques currently employed for the cultivation of the major types of live food commonly used in larviculture, as well as their application potential in terms of their nutritional and physical properties and feeding methods. The manual is divided into different sections according to the major groups of live food organisms used in aquaculture, namely micro-algae, rotifers, *Artemia*, natural zooplankton, and copepods, nematodes and trochophores.

Distribution:

Directors of Fisheries and Aquaculture
FAO Regional Fishery Commissions and Working Groups on Aquaculture
FAO Fisheries Department
FAO Regional Fisheries Officers
FAO Aquaculture Projects
FAO Representatives

CONTENTS

	<u>Page</u>
1. INTRODUCTION (by Patrick Lavens and Patrick Sorgeloos)	1
2. MICRO-ALGAE (by Peter Coutteau)	7
2.1. Introduction	7
2.2. Major classes and genera of cultured algal species	8
2.3. Algal production.....	10
2.3.1. Physical and chemical conditions.....	10
2.3.1.1. Culture medium/nutrients.....	10
2.3.1.2. Light.....	13
2.3.1.3. pH.....	13
2.3.1.4. Aeration/mixing	14
2.3.1.5. Temperature.....	14
2.3.1.6. Salinity	14
2.3.2. Growth dynamics	14
2.3.3. Isolating/obtaining and maintaining of cultures	16
2.3.4. Sources of contamination and water treatment.	16
2.3.5. Algal culture techniques	18
2.3.5.1. Batch culture.....	19
2.3.5.2. Continuous culture	23
2.3.5.3. Semi-continuous culture	26
2.3.6. Algal production in outdoor ponds	26
2.3.7. Culture of sessile micro-algae.....	27
2.3.8. Quantifying algal biomass.....	27
2.3.9. Harvesting and preserving micro-algae	29
2.3.10 Algal production cost	30
2.4. Nutritional value of micro-algae	31
2.5. Use of micro-algae in aquaculture	36
2.5.1. Bivalve molluscs	36
2.5.2. Penaeid shrimp.....	39
2.5.3. Marine fish	39
2.6. Replacement diets for live algae.....	40
2.6.1. Preserved algae	41
2.6.2. Micro-encapsulated diets	41
2.6.3. Yeast-based diets	41
2.7. Literature of interest	42
2.8. Worksheets	44
Worksheet 2.1. : Isolation of pure algal strains by the agar plating technique	44
Worksheet 2.2. : Determination of cell concentrations using haematocytometer according to Fuchs-Rosenthal and Burker.....	45
Worksheet 2.3. : Cellular dry weight estimation of micro-algae.....	47
3. ROTIFERS (by Philippe Dhert)	49
3.1. Introduction.....	49
3.2. Morphology.....	49
3.3. Biology and life history	50
3.4. Strain differences... ..	51
3.5. General culture conditions	53

3.5.1.	Marine rotifers.....	53
3.5.1.1.	Salinity	53
3.5.1.2.	Temperature.....	53
3.5.1.3.	Dissolved oxygen.....	53
3.5.1.4.	pH.....	54
3.5.1.5.	Ammonia (NH ₃)	54
3.5.1.6.	Bacteria	54
3.5.1.7.	Ciliates	55
3.5.2.	Freshwater rotifers	55
3.5.3.	Culture procedures.....	55
3.5.3.1.	Stock culture of rotifers.....	55
3.5.3.2.	Upscaling of stock cultures to starter cultures.....	57
3.5.3.3.	Mass production on algae	58
3.5.3.4.	Mass production on algae and yeast	58
3.5.3.5.	Mass culture on yeast	59
3.5.3.6.	Mass culture on formulated diets.....	59
3.5.3.7.	High density rearing	63
3.5.4.	Harvesting/concentration of rotifers.....	64
3.6.	Nutritional value of cultured rotifers.....	65
3.6.1.	Techniques for (n-3) HUFA enrichment	65
3.6.1.1.	Algae.....	65
3.6.1.2.	Formulated feeds	66
3.6.1.3.	Oil emulsions.....	67
3.6.2.	Techniques for vitamin C enrichment	70
3.6.3.	Techniques for protein enrichment.....	72
3.6.4.	Harvesting/concentration and cold storage of rotifers	74
3.7.	Production and use of resting eggs.....	74
3.8.	Literature of interest.....	76
3.9.	Worksheets.....	78
	Worksheet 3.1. : Preparation of an indicator solution for determination of residual chlorine	78
4.	ARTEMIA.....	79
4.1.	Introduction, biology and ecology of <i>Artemia</i> (by Gilbert Van Stappen)	79
4.1.1.	Introduction	79
4.1.2.	Biology and ecology of <i>Artemia</i>	80
4.1.2.1.	Morphology and life cycle	80
4.1.2.2.	Ecology and natural distribution.....	88
4.1.2.3.	Taxonomy.....	101
4.1.2.4.	Strain-specific characteristics.....	101
4.1.3.	Literature of interest	106
4.2.	Use of cysts (by Gilbert Van Stappen)	107
4.2.1.	Cyst biology.....	107
4.2.1.1.	Cyst morphology.....	107
4.2.1.2.	Physiology of the hatching process	108
4.2.1.3.	Effect of environmental conditions on cyst metabolism	109
4.2.1.4.	<i>Diapause</i>	111
4.2.2.	Disinfection procedures	114
4.2.3.	Decapsulation	115
4.2.4.	Direct use of decapsulated cysts.....	116
4.2.5.	Hatching.....	118

	4.2.5.1.	Hatching conditions and equipment.....	118	
	4.2.5.2.	Hatching quality and evaluation.....	119	
4.2.6.		Literature of interest	123	
4.2.7.		Worksheets.....	124	
	Worksheet 4.2.1.:	Procedure for estimating water content of <i>Artemia</i> cysts.....	124	
	Worksheet 4.2.2.:	Specific diapause termination techniques	125	
	Worksheet 4.2.3.:	Disinfection of <i>Artemia</i> cysts with liquid bleach	126	
	Worksheet 4.2.4.:	Procedures for decapsulation of <i>Artemia</i> cysts	127	
	Worksheet 4.2.5.:	Titrimetric method for the determination of active chlorine in hypochlorite solutions.....	128	
	Worksheet 4.2.6.:	<i>Artemia</i> hatching.....	129	
	Worksheet 4.2.7.:	Determination of hatching percentage, hatching efficiency and hatching rate.....	130	
4.3.		Use of nauplii and meta-nauplii (by Greet Merchie)	137	
	4.3.1.	Harvesting and distribution	137	
	4.3.2.	Cold storage	140	
	4.3.3.	Nutritional quality	140	
	4.3.4.	Enrichment with nutrients.....	144	
	4.3.5.	Enrichment for disease control	149	
	4.3.6.	Applications of <i>Artemia</i> for feeding different species.....	151	
		4.3.6.1. Penaeid shrimp.....	151	
		4.3.6.2. Freshwater prawn.....	153	
		4.3.6.3. Marine fish.....	155	
		4.3.6.4. Freshwater fish.....	157	
		4.3.6.5. Aquarium fish.....	158	
	4.3.7.	Literature of interest	158	
	4.3.8.	Worksheets.....	161	
		Worksheet 4.3.1.:	Standard enrichment for Great Salt Lake <i>Artemia</i>	161
4.4.		Tank production and use of ongrown <i>Artemia</i> (by Jean Dhont and Patrick Lavens).....	164	
	4.4.1.	Nutritional properties of ongrown <i>Artemia</i>	164	
	4.4.2.	Tank production	166	
		4.4.2.1. Advantages of tank production and tank produced biomass	166	
		4.4.2.2. Physico-chemical conditions.....	167	
		4.4.2.3. <i>Artemia</i>	171	
		4.4.2.4. Feeding.....	172	
		4.4.2.5. Infrastructure	176	
		4.4.2.6. Culture techniques	182	
		4.4.2.7. Enrichment of ongrown <i>Artemia</i>	188	
		4.4.2.8. Control of infections.....	189	
		4.4.2.9. Harvesting and processing techniques.....	190	
		4.4.2.10. Production figures and production costs	190	
	4.4.3.	Literature of interest	193	
	4.4.4.	Worksheets.....	195	
		Worksheet 4.4.1.:	Feeding strategy for intensive <i>Artemia</i> culture.....	195

4.5.	Pond production	
	(by Peter Baert, Thomas Bosteels and Patrick Sorgeloos)	196
4.5.1.	Description of the different <i>Artemia</i> habitats	196
4.5.1.1.	Natural lakes	196
4.5.1.2.	Permanent solar salt operations	196
4.5.1.3.	Seasonal units	199
4.5.2.	Site selection	201
4.5.2.1.	Climatology	201
4.5.2.2.	Topography	201
4.5.2.3.	Soil conditions	202
4.5.3.	Pond adaptation	202
4.5.3.1.	Large permanent salt operations	202
4.5.3.2.	Small pond systems	203
4.5.4.	Pond preparation	206
4.5.4.1.	Liming	206
4.5.4.2.	Predator control	206
4.5.4.3.	Fertilization	207
4.5.5.	<i>Artemia</i> inoculation	213
4.5.5.1.	<i>Artemia</i> strain selection	213
4.5.5.2.	Inoculation procedures	214
4.5.6.	Monitoring and managing the culture system	215
4.5.6.1.	Monitoring the <i>Artemia</i> population	218
4.5.6.2.	Abiotic parameters influencing <i>Artemia</i> populations	220
4.5.6.3.	Biotic factors influencing <i>Artemia</i> populations	222
4.5.7.	Harvesting and processing techniques	225
4.5.7.1.	<i>Artemia</i> biomass harvesting and processing	225
4.5.7.2.	<i>Artemia</i> cyst harvesting and processing	228
4.5.8.	Literature of interest	242
4.5.9.	Worksheets	244
	Worksheet 4.5.1.: Pond improvements and harvesting procedures	244
	Worksheet 4.5.2.: Procedures for the brine processing step	247
	Worksheet 4.5.3.: Procedures for the freshwater processing step	250
5.	ZOOPLANKTON	
	(by Daan Delbare, Philippe Dhert, Patrick Lavens)	252
5.1.	Wild zooplankton	252
5.1.1.	Introduction	252
5.1.2.	Collection from the wild	256
5.1.3.	Collection techniques	256
5.1.3.1.	Plankton nets	257
5.1.3.2.	Trawl nets	258
5.1.3.3.	Baleen harvesting system	258
5.1.3.4.	Flow-through harvesting	259
5.1.3.5.	Plankton light trapping	262
5.1.4.	Zooplankton grading	263
5.1.5.	Transport and storage of collected zooplankton	264

5.2.	Production of copepods	265
	5.2.1. Introduction	265
	5.2.2. Life cycle.....	266
	5.2.3. Biometrics	266
	5.2.4. Nutritional quality	267
	5.2.5. Culture techniques.....	270
	5.2.5.1. Calanoids.....	270
	5.2.5.2. Harpacticoids	271
	5.2.6. Use of resting eggs.....	272
	5.2.7. Applications in larviculture.....	273
5.3.	Mesocosm systems	274
	5.3.1. Introduction	274
	5.3.2. Types of mesocosms	274
	5.3.2.1. Pold sytem (2-60 m ³)	275
	5.3.2.2. Bag system (50-200 m ³).....	275
	5.3.2.3. Pond system	276
	5.3.2.4. Tank system	277
	5.3.3. Mesocosm protocol.....	278
	5.3.4. Comparison to intensive methods.....	280
5.4.	Literature of interest	281
6.	CLADOCERANS, NEMATODES AND TROCHOPHORA LARVAE	
	(by Daan Delbare and Philippe Dhert).....	283
6.1.	<i>Daphnia</i> and <i>Moina</i>	283
	6.1.1. Biology and life cycle of <i>Daphnia</i>	283
	6.1.2. Nutritional value of <i>Daphnia</i>	284
	6.1.3. Feeding and nutrition of <i>Daphnia</i>	284
	6.1.4. Mass culture of <i>Daphnia</i>	285
	6.1.4.1. General procedure for tank culture	285
	6.1.4.2. Detrital system	286
	6.1.4.3. Autotrophic system.....	286
	6.1.4.4. General procedure for pond culture	287
	6.1.4.5. Contamination	288
	6.1.5. Production and use of resting eggs	288
	6.1.6. Use of <i>Moina</i>	288
6.2.	Nematodes	289
6.3.	Trochophora larvae	293
	6.3.1. Introduction	293
	6.3.2. Production of trochophora larvae	293
	6.3.2.1. Mussel larvae	293
	6.3.2.2. Pacific oyster and Manila clam larvae.....	294
	6.3.3. Quality control of the produced trochophora larvae.....	294
	6.3.4. Cryopreservation	294
6.4.	Literature of interest	295

1. INTRODUCTION

Patrick Lavens and Patrick Sorgeloos

Laboratory of Aquaculture & Artemia Reference Center
University of Gent, Belgium

Whereas in the 1970s the production of farmed marine finfish and shrimp relied almost exclusively on the capture of wild fry for subsequent stocking and on-growing in ponds, tanks or cages, the complete domestication of many marine and brackishwater aquaculture species was only achieved during the last two decades. However, since then the controlled production of larvae from captive broodstock, or in other words the hatchery production of fry, has now become a routine operation for most cultivated fish and shellfish species; billions of fish and shellfish larvae (i.e. bivalve molluscs, penaeid shrimp, salmonids, European seabass, Gilthead seabream etc.) currently being produced within hatcheries all over the world.

The cultivation of larvae is generally carried out under controlled hatchery conditions and usually requires specific culture techniques which are normally different from conventional nursery and grow-out procedures, and especially with respect to husbandry techniques, feeding strategies, and microbial control. The main reason for this is that the developing larvae are usually very small, extremely fragile, and generally not physiologically fully developed. For example, their small size (ie. small mouth size), the uncompleted development of their perception organs (ie. eyes, chemoreceptors) and digestive system, are limiting factors in proper feed selection and use during the early first-feeding or start-feeding period. Moreover, in species such as shrimp, these are not the only problems as the developing larvae also have to pass through different larval stages, eventually changing from a herbivorous filter feeding behaviour to a carnivorous hunting behaviour. It is perhaps not surprising therefore that larval nutrition, and in particular that of the sensitive first-feeding larvae, has become one of the major bottlenecks preventing the full commercialization of many farmed fish and shellfish species. This can also be illustrated by the following examples.

- **Larval/mouth size at first-feeding**

The mouth size of first-feeding larvae usually mechanically restricts the size of the food particles which can be ingested. In general, mouth size is correlated with body size, which in turn is influenced by egg diameter and the period of endogenous feeding (ie. yolk sac consumption period). For example, Atlantic salmon eggs are usually at least four times larger than Gilthead seabream eggs (Table 1.1), and consequently on hatching yield large salmon larvae with large yolk sac supplies (ie. sufficient endogenous feed reserves for the first three weeks of their development), whereas first-feeding Gilthead seabream larvae are very small with limited yolk sac reserves, and consequently can only feed endogenously for about three days (Figures 1.1, 1.2 and 1.3). For example, at first-feeding salmonid 'alevins' are able to consume feed particles as large as 1 mm, compared with only 0.1 mm in the case of first-feeding Gilthead seabream larvae.

Table 1.1. Size of eggs and larval length at hatching in different fish species (modified from Jones and Houde, 1981).

Species	Egg diameter (mm)	Length of larvae (mm)
Atlantic salmon (<i>Salmo salar</i>)	5.0 - 6.0	15.0 - 25.0
Rainbow trout (<i>Oncorhynchus mykiss</i>)	4.0	12.0 - 20.0
Common carp (<i>Cyprinus carpio</i>)	0.9 - 1.6	4.8 - 6.2
European sea bass (<i>Dicentrarchus labrax</i>)	1.2 - 1.4	7.0 - 8.0
Gilthead seabream (<i>Sparus aurata</i>)	0.9 - 1.1	3.5 - 4.0
Turbot (<i>Scophthalmus maximus</i>)	0.9 - 1.2	2.7 - 3.0
Sole (<i>Solea solea</i>)	1.0 - 1.4	3.2 - 3.7
Milkfish (<i>Chanos chanos</i>)	1.1 - 1.25	3.2 - 3.4
Grey mullet (<i>Mugil cephalus</i>)	0.9 - 1.0	1.4 - 2.4
Greasy grouper (<i>Epinephelus tauvina</i>)	0.77 - 0.90	1.4 - 2.4
Bream (<i>Acanthopagrus cuvieri</i>)	0.78 - 0.84	1.8 - 2.0



Figure 1.1. Atlantic salmon larvae with yolk sac.

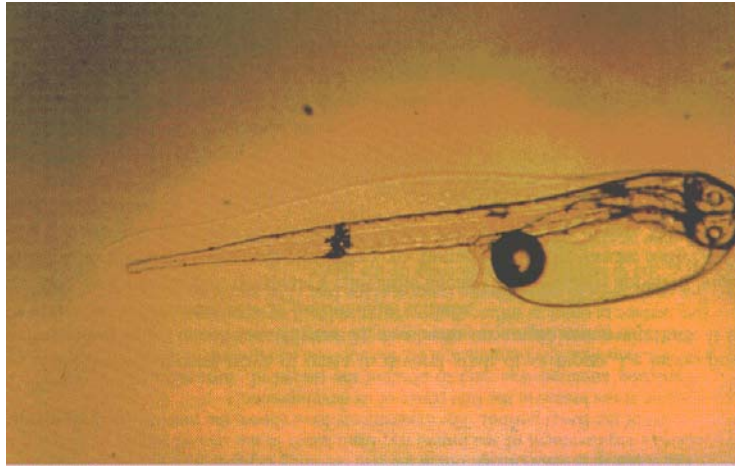

Figure 1.2. Gilthead seabream larva with yolk sac.



Figure 1.3. Atlantic salmon and gilthead seabream larvae at first feeding.

- **Functional digestive tract**

The developmental status of the digestive system of first-feeding larvae also dictates the possibility or not of the larvae to digest the food ingested. For example, first-feeding salmon alevins already have a well developed digestive tract with functioning enzyme systems which allow the digestion of feed crumbles on first-feeding. By contrast, Gilthead seabream larvae (like many other fish larvae; Figure 1.4) do not have a functional stomach, but only a short digestive tract with only a few functional enzyme systems at the onset of first-feeding. It follows therefore that these fish larvae will have to rely on a food source that: 1) is at least partially and easily digestible (ie. the feed should contain large amounts of free amino acids and oligopeptides instead of indigestible complex protein molecules), 2) contains enzyme systems which allow autolysis (ie. self destruction of the food particle), and 3) supplies in abundance all the essential nutrients required by the larval predator.



Figure 1.4. Ontogenetic development of the digestive tract in cyprinid type fish (i.e. common carp; modified from Dabrowski, 1984).

However, formulated feeds do not generally meet all these requirements and usually result in poor growth and survival in small fish larvae such as the Gilthead seabream. On the otherhand live food organisms seem to meet all the necessary criteria for these small larvae. However, for food to be ingested by a larva it first has to be detected, and so the degree of development of the functional sense organs such as the optical receptors (eyes), chemoreceptors (olfactory organs, tastebuds) and mechanoreceptors (lateral line) is crucial. For example, the eyes of fish larvae usually only contain cones in the retina resulting in poor visibility, whereas the eyes of juvenile fish also contain rods with more visual pigments in the retina. Moreover, live food organisms usually have a much better contrast than artificial feeds and generally have a triggering effect by their continuous movement, allowing an enhanced perception by the feeding larva. Similarly, the swimming activity of live food organisms generally assures a good distribution of food items in the water column, this in turn facilitating more frequent encounters with the developing larvae which in most cases have a low mobility.

The aim of the present manual is to describe the various techniques employed for the production and application of live food organisms as well as their application in larviculture. The natural diet of most cultured fish and shellfish species consists of a wide diversity of phytoplankton species (diatoms, flagellates, etc.) and zooplankton organisms (copepods, cladocerans, decapod larvae, rotifers, ciliates, etc.), found in great abundance in the natural plankton. This abundance and maximal diversity of food organisms of different sizes and nutritional composition provide maximal chances for meeting all the requirements of the predator larvae. Although the collection and/or production of natural plankton for feeding in commercial hatcheries may therefore appear evident, in practice the use of natural plankton

often entails many constraints which will be explained in detail in chapter 5. For the industrial larviculture of fish and shellfish, readily and consistently available, practical and performing live diets need to be selected.

The selection of a suitable and nutritious diet should be based on a number of criteria (Fig. 1.5.). Most of the criteria as identified from the viewpoint of the larva have already been discussed above with the exception of the criterion 'purity'. One should not only consider the impurities by alien particles, but also the hygienic condition of the diet. Contamination of live food with bacteria is not necessarily hazardous but may have a tremendous impact on the microbial populations in the associated culture medium and eventually in the fish/shrimp's gut flora, and consequently on the health status and the digestive capability of the larva (i.e. an impact that has only been fully realized in recent years; see also chapters 3, 4.3 and 4.4).

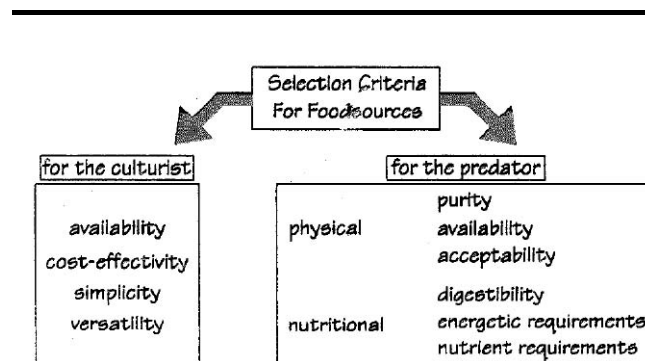

Figure 1.5. Selection criteria for larval food sources from the viewpoint of the culturist and the cultured larva (modified from Léger et al., 1987).

From the practical viewpoint of the culturist, a good diet should be readily available, cost-effective, simple as well as versatile in application. The consistent availability of sufficient quantities of food organisms is of the utmost importance in continuous hatchery productions. In this respect, the collection and feeding of wild plankton has proven unreliable and not always practical (see also chapter 5).

Over the past decades, trial and error approaches have resulted in the adoption of selected larviculture diets, taking into account the different criteria listed in Fig. 1.5. Today, three groups of live diets are widely applied in industrial larviculture of fish and shellfish:

- different species of 2 to 20 µm microalgae for:
 - o bivalves
 - o penaeid shrimp
 - o rotifers, copepods, ...
 - o fish

- the 50 to 200 µm rotifer *Brachionus plicatilis* for:
 - crustaceans
 - marine fish

- the 400 to 800 µm brine shrimp *Artemia* spp. (meta-)nauplii for:
 - crustaceans
 - fish

Apart from these main groups, a few other live feeds are used on a more limited scale for specific larviculture practices, including *Brachionus rubens*, *Moina* spp., daphnids, and decapsulated brine shrimp cysts for freshwater fish and prawn larvae, and *Artemia* biomass for lobster larvae, shrimp postlarvae and broodstock, and marine fish juveniles. In recent years various formulations of supplementation and substitution products have been added to this list although replacement diets are becoming more and more successful in shrimp larviculture. However, their use in first-feeding marine fish is still very limited.

Finally, a selection criterion that also needs to be addressed, especially at competitive market prices of hatchery fry (for example, European seabass and gilthead seabream prices have decreased by more than 50% over the last few years) is the larval feed cost, which, depending on the species and culture technique applied, may account for up to 15% of the total production cost. Optimization of live food production and use in hatcheries has therefore become even more important. This issue will also be further elaborated in the different chapters of this manual.

Literature cited

- Dabrowski, K., 1984. Ontogenetic development of cyprinid-like type of digestive tract. *Reprod. Nutr. Develop.* 24:807-819
- Jones, A. and Houde E.D., 1981. Mass rearing of fish fry for aquaculture. p.351-374. In: *realism in aquaculture: achievements, constraints, perspectives.* Bilio, M., Rosenthal, H. and Sinderman, G.J. (eds). European Aquaculture Society, Bredene, Belgium, 585 p.
- Leger, P., Bengtson, D.A., Sorgeloos, P., Simpson, K.L. and Beck, A.D., 1987. The nutritional value of *Artemia*: a review, p. 357-372. In: *Artemia research and its applications.* Vol. 3. Sorgeloos, P., Bengtson, D.A., Declerck, W., Jaspers, (eds). Universa Press, Wetteren, Belgium, 556 p.

2. MICRO-ALGAE

Peter Coutteau

Laboratory of Aquaculture & Artemia Reference Center
University of Gent, Belgium

2.1. Introduction

Phytoplankton comprises the base of the food chain in the marine environment. Therefore, micro-algae are indispensable in the commercial rearing of various species of marine animals as a food source for all growth stages of bivalve molluscs, larval stages of some crustacean species, and very early growth stages of some fish species. Algae are furthermore used to produce mass quantities of zooplankton (rotifers, copepods, brine shrimp) which serve in turn as food for larval and early-juvenile stages of crustaceans and fish (Fig. 2.1.). Besides, for rearing marine fish larvae according to the "green water technique"

algae are used directly in the larval tanks, where they are believed to play a role in stabilizing the water quality, nutrition of the larvae, and microbial control.

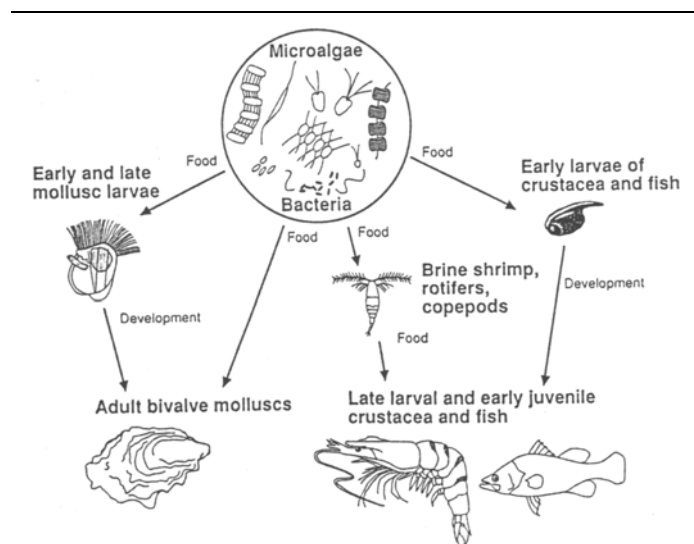

Figure 2.1. The central role of micro-algae in mariculture (Brown *et al.*, 1989).

All algal species are not equally successful in supporting the growth and survival of a particular filter-feeding animal. Suitable algal species have been selected on the basis of their mass-culture potential, cell size, digestibility, and overall food value for the feeding animal. Various techniques have been developed to grow these food species on a large scale, ranging from less controlled extensive to monospecific intensive cultures. However, the controlled production of micro-algae is a complex and expensive procedure. A possible alternative to on-site algal culture is the collection of algae from the natural environment where, under certain conditions, they may be extremely abundant. Furthermore, in order to overcome or reduce the problems and limitations associated with algal cultures, various

investigators have attempted to replace algae using artificial diets either as a supplement or as the main food source. These various aspects of the production, use and substitution of micro-algae in aquaculture will be treated within the limits of this chapter.

2.2. Major classes and genera of cultured algal species

Today, more than 40 different species of micro-algae, isolated in different parts of the world, are cultured as pure strains in intensive systems. Table 2.1. lists the eight major classes and 32 genera of cultured algae currently used to feed different groups of commercially important aquatic organisms. The list includes species of diatoms, flagellated and chlorococcalean green algae, and filamentous blue-green algae, ranging in size from a few micrometer to more than 100 μm . The most frequently used species in commercial mariculture operations are the diatoms *Skeletonema costatum*, *Thalassiosira pseudonana*, *Chaetoceros gracilis*, *C. calcitrans*, the flagellates *Isochrysis galbana*, *Tetraselmis suecica*, *Monochrysis lutheri* and the chlorococcalean *Chlorella* spp. (Fig. 2.2.).

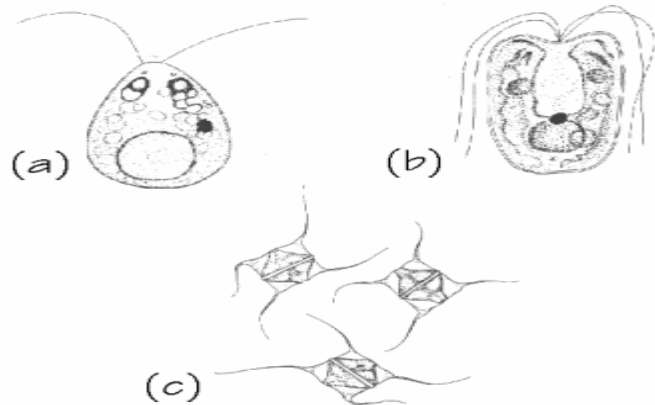

Figure 2.2. Some types of marine algae used as food in aquaculture (a) *Tetraselmis* spp. (b) *Dunaliella* spp. (c) *Chaetoceros* spp. (Laing, 1991).

Table 2.1. Major classes and genera of micro-algae cultured in aquaculture (modified from De Pauw and Persoone, 1988) .

Class	Genus	Examples of application
Bacillariophyceae	<i>Skeletonema</i>	PL,BL,BP
	<i>Thalassiosira</i>	PL,BL,BP
	<i>Phaeodactylum</i>	PL,BL,BP,ML,BS
	<i>Chaetoceros</i>	PL,BL,BP,BS
	<i>Cylindrotheca</i>	PL
	<i>Bellerochea</i>	BP
	<i>Actinocyclus</i>	BP
	<i>Nitzschia</i>	BS
Haptophyceae	<i>Isochrysis</i>	PL,BL,BP,ML,BS
	<i>Pseudoisochrysis</i>	BL,BP,ML
	<i>dicrateria</i>	BP
Chrysophyceae	<i>Monochrysis (Pavlova)</i>	BL,BP,BS,MR
Prasinophyceae	<i>Tetraselmis (Platymonas)</i>	PL,BL,BP,AL,BS,MR
	<i>Pyramimonas</i>	BL,BP
	<i>Micromonas</i>	BP
Cryptophyceae	<i>Chroomonas</i>	BP
	<i>Cryptomonas</i>	BP
	<i>Rhodomonas</i>	BL,BP
Cryptophyceae	<i>Chlamydomonas</i>	BL,BP,FZ,MR,BS
	<i>Chlorococcum</i>	BP
Xanthophyceae	<i>Olisthodiscus</i>	BP
Chlorophyceae	<i>Carteria</i>	BP
	<i>Dunaliella</i>	BP,BS,MR
Cyanophyceae	<i>Spirulina</i>	PL,BP,BS,MR

PL, penaeid shrimp larvae; BL, bivalve mollusc larvae; ML, freshwater prawn larvae; BP, bivalve mollusc postlarvae; AL, abalone larvae; MR, marine rotifers (*Brachionus*); BS, brine shrimp (*Artemia*); SC, saltwater copepods; FZ, freshwater zooplankton

2.3. Algal production

2.3.1. Physical and chemical conditions

The most important parameters regulating algal growth are nutrient quantity and quality, light, pH, turbulence, salinity and temperature. The most optimal parameters as well as the tolerated ranges are species specific and a broad generalization for the most important parameters is given in Table 2.2. Also, the various factors may be interdependent and a parameter that is optimal for one set of conditions is not necessarily optimal for another.

2.3.1.1. Culture medium/nutrients

Concentrations of cells in phytoplankton cultures are generally higher than those found in nature. Algal cultures must therefore be enriched with nutrients to make up for the deficiencies in the seawater. Macronutrients include nitrate, phosphate (in an approximate ratio of 6:1), and silicate.

Table 2.2. A generalized set of conditions for culturing micro-algae (modified from Anonymous, 1991).

Parameters	Range	Optima
Temperature (°C)	16-27	18-24
Salinity (g.l ⁻¹)	12-40	20-24
Light intensity (lux)	1,000-10,000 (depends on volume and density)	2,500-5,000
Photoperiod (light:dark, hours)		16:8 (minimum) 24:0 (maximum)
pH	7-9	8.2-8.7

Silicate is specifically used for the growth of diatoms which utilize this compound for production of an external shell. Micronutrients consist of various trace metals and the vitamins thiamin (B₁), cyanocobalamin (B₁₂) and sometimes biotin. Two enrichment media that have been used extensively and are suitable for the growth of most algae are the Walne medium (Table 2.3.) and the Guillard's F₂ medium (Table 2.4.). Various specific recipes for algal culture media are described by Vonshak (1986). Commercially available nutrient solutions may reduce preparation labour. The complexity and cost of the above culture media often excludes their use for large-scale culture operations. Alternative enrichment media that are suitable for mass production of micro-algae in large-scale extensive systems contain only the most essential nutrients and are composed of agriculture-grade rather than laboratory-grade fertilizers (Table 2.5.).

Table 2.3. Composition and preparation of Walne medium (modified from Laing, 1991).	
Constituents	Quantities
Solution A (at 1 ml per liter of culture)	
Ferric chloride (FeCl ₃)	0.8 g ^(a)
Manganous chloride (MnCl ₂ .4H ₂ O)	0.4 g
Boric acid (H ₃ BO ₃)	33.6 g
EDTA ^(b) , di-sodium salt	45.0 g
Sodium di-hydrogen orthophosphate (NaH ₂ PO ₄ .2H ₂ O)	20.0 g
Sodium nitrate (NaNO ₃)	100.0 g
Solution B	1.0 ml
Make up to 1 litre with fresh water ^(c)	Heat to dissolve
Solution B	
Zinc chloride (ZnCl ₂)	2.1 g
Cobaltous chloride (CoCl ₂ .6H ₂ O)	2.0 g
Ammonium molybdate ((NH ₄) ₆ Mo ₇ O ₂₄ .4H ₂ O)	0.9 g
Cupric sulphate (CuSO ₄ .5H ₂ O)	2.0 g
Concentrated HCl	10.0 ml
Make up to 100 ml fresh water ^(c)	Heat to dissolve
Solution C (at 0.1 ml per liter of culture)	
Vitamin B ₁	0.2 g
Solution E	25.0 ml
Make up to 200 ml with fresh water ^(c)	
Solution D (for culture of diatoms-used in addition to solutions A and C, at 2 ml per liter of culture)	
Sodium metasilicate (Na ₂ SiO ₃ .5H ₂ O)	40.0 g
Make up to 1 litre with fresh water ^(c)	Shake to dissolve
Solution E	
Vitamin B ₁₂	0.1 g
make up to 250 ml with fresh water ^(c)	
Solution F (for culture of <i>Chroomonas salina</i> - used in addition to solutions A and C, at 1 ml per liter of culture)	
Sodium nitrate (NaNO ₃)	200.0 g
make up to 1 litre with fresh water ^(c)	
(a) Use 2.0 g for culture of <i>Chaetoceros calcitrans</i> in filtered sea water; (b) Ethylene diamine tetra acetic acid; (c) Use distilled water if possible.	

Table 2.4. Composition and preparation of Guillard's $F/2$ medium (modified from Smith <i>et al.</i>, 1993a).		
Nutrients	Final concentration (mg.l ⁻¹ seawater) ^a	Stock solution preparations
NaNO ₃	75	Nitrate/Phosphate Solution Working Stock: add 75 g NaNO ₃ + 5 g NaH ₂ PO ₄ to 1 liter distilled water (DW)
NaH ₂ PO ₄ .H ₂ O	5	
Na ₂ SiO ₃ .9H ₂ O	30	Silicate Solution Working Stock: add 30 g Na ₂ SiO ₃ to 1 liter DW
Na ₂ C ₁₀ H ₁₄ O ₈ N ₂ .H ₂ O (Na ₂ EDTA)	4.36	Trace Metal/EDTA Solution Primary stocks: make 5 separate 1-liter stocks of (g.l ⁻¹ DW) 10.0 g CoCl ₂ , 9.8 g CuSO ₄ , 180 g MnCl ₂ , 6.3 g Na ₂ MoO ₄ , 22.0 g ZnSO ₄ Working stock: add 1 ml of each primary stock solution + 4.35 g Na ₂ C ₁₀ H ₁₄ O ₈ N ₂ + 3.15 g FeCl ₃ to 1 liter DW
CoCl ₂ .6H ₂ O	0.01	
CuSO ₄ .5H ₂ O	0.01	
FeCl ₃ .6H ₂ O	3.15	
MnCl ₂ .4H ₂ O	0.18	
Na ₂ MoO ₄ .2H ₂ O	0.006	
ZnSO ₄ .7H ₂ O	0.022	
Thiamine HCl	0.1	Vitamin Solution Primary stock: add 20 g thiamin HCl + 0.1 g biotin + 0.1 g B ₁₂ to 1 liter DW
Biotin	0.0005	
B ₁₂	0.0005	Working stock: add 5 ml primary stock to 1 liter DW

Table 2.5. Various combinations of fertilizers that can be used for mass culture of marine algae (modified from Palanisamy *et al.*, 1991).

Fertilizers	Concentration (mg.l ⁻¹)					
	A	B	C	D	E	F
Ammonium sulfate	150	100	300	100	-	-
Urea	7.5	5	-	10-15	-	12-15
Calcium superphosphate	25	15	50	-	-	-
Clewat 32	-	5	-	-	-	-
N:P 16/20 fertilizer	-	-	-	10-15	-	-
N:P:K 16-20-20	-	-	-	-	12-15	-
N:P:K 14-14-14	-	-	-	-	-	30

2.3.1.2. Light

As with all plants, micro-algae photosynthesize, *i.e.* they assimilate inorganic carbon for conversion into organic matter. Light is the source of energy which drives this reaction and in this regard intensity, spectral quality and photoperiod need to be considered. Light intensity plays an important role, but the requirements vary greatly with the culture depth and the density of the algal culture: at higher depths and cell concentrations the light intensity must be increased to penetrate through the culture (*e.g.* 1,000 lux is suitable for erlenmeyer flasks, 5,000-10,000 is required for larger volumes). Light may be natural or supplied by fluorescent tubes. Too high light intensity (*e.g.* direct sun light, small container close to artificial light) may result in photo-inhibition. Also, overheating due to both natural and artificial illumination should be avoided. Fluorescent tubes emitting either in the blue or the red light spectrum should be preferred as these are the most active portions of the light spectrum for photosynthesis. The duration of artificial illumination should be minimum 18 h of light per day, although cultivated phytoplankton develop normally under constant illumination.

2.3.1.3. pH

The pH range for most cultured algal species is between 7 and 9, with the optimum range being 8.2-8.7. Complete culture collapse due to the disruption of many cellular processes can result from a failure to maintain an acceptable pH. The latter is accomplished by aerating the culture (see below). In the case of high-density algal culture, the addition of carbon dioxide allows to correct for increased pH, which may reach limiting values of up to pH 9 during algal growth.

2.3.1.4. Aeration/mixing

Mixing is necessary to prevent sedimentation of the algae, to ensure that all cells of the population are equally exposed to the light and nutrients, to avoid thermal stratification (e.g. in outdoor cultures) and to improve gas exchange between the culture medium and the air. The latter is of primary importance as the air contains the carbon source for photosynthesis in the form of carbon dioxide. For very dense cultures, the CO₂ originating from the air (containing 0.03% CO₂) bubbled through the culture is limiting the algal growth and pure carbon dioxide may be supplemented to the air supply (e.g. at a rate of 1% of the volume of air). CO₂ addition furthermore buffers the water against pH changes as a result of the CO₂/HCO₃⁻ balance. Depending on the scale of the culture system, mixing is achieved by stirring daily by hand (test tubes, erlenmeyers), aerating (bags, tanks), or using paddle wheels and jetpumps (ponds). However, it should be noted that not all algal species can tolerate vigorous mixing.

2.3.1.5. Temperature

The optimal temperature for phytoplankton cultures is generally between 20 and 24°C, although this may vary with the composition of the culture medium, the species and strain cultured. Most commonly cultured species of micro-algae tolerate temperatures between 16 and 27°C. Temperatures lower than 16°C will slow down growth, whereas those higher than 35°C are lethal for a number of species. If necessary, algal cultures can be cooled by a flow of cold water over the surface of the culture vessel or by controlling the air temperature with refrigerated air- conditioning units.

2.3.1.6. Salinity

Marine phytoplankton are extremely tolerant to changes in salinity. Most species grow best at a salinity that is slightly lower than that of their native habitat, which is obtained by diluting sea water with tap water. Salinities of 20-24 g.l⁻¹ have been found to be optimal.

2.3.2. Growth dynamics

The growth of an axenic culture of micro-algae is characterized by five phases (Fig. 2.3.):

- lag or induction phase

This phase, during which little increase in cell density occurs, is relatively long when an algal culture is transferred from a plate to liquid culture. Cultures inoculated with exponentially growing algae have short lag phases, which can seriously reduce the time required for upscaling. The lag in growth is attributed to the physiological adaptation of the cell metabolism to growth, such as the increase of the levels of enzymes and metabolites involved in cell division and carbon fixation.

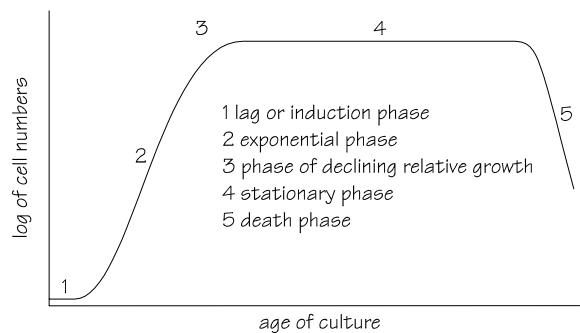

Figure 2.3. Five growth phases of micro-algae cultures.

- exponential phase

During the second phase, the cell density increases as a function of time t according to a logarithmic function:

$$C_t = C_0 \cdot e^{mt}$$

with C_t and C_0 being the cell concentrations at time t and 0, respectively, and m = specific growth rate. The specific growth rate is mainly dependent on algal species, light intensity and temperature.

- phase of declining growth rate

Cell division slows down when nutrients, light, pH, carbon dioxide or other physical and chemical factors begin to limit growth.

- stationary phase

In the fourth stage the limiting factor and the growth rate are balanced, which results in a relatively constant cell density.

- death or "crash" phase

During the final stage, water quality deteriorates and nutrients are depleted to a level incapable of sustaining growth. Cell density decreases rapidly and the culture eventually collapses.

In practice, culture crashes can be caused by a variety of reasons, including the depletion of a nutrient, oxygen deficiency, overheating, pH disturbance, or contamination. The key to the success of algal production is maintaining all cultures in the exponential phase of growth. Moreover, the nutritional value of the produced algae is inferior once the culture is beyond phase 3 due to reduced digestibility, deficient composition, and possible production of toxic metabolites.

2.3.3. Isolating/obtaining and maintaining of cultures

Sterile cultures of micro-algae used for aquaculture purposes may be obtained from specialized culture collections. A list of culture collections is provided by Vonshak (1986) and Smith *et al.* (1993a). Alternatively, the isolation of endemic strains could be considered because of their ability to grow under the local environmental conditions. Isolation of algal species is not simple because of the small cell size and the association with other epiphytic species. Several laboratory techniques are available for isolating individual cells, such as serial dilution culture, successive plating on agar media (See Worksheet 2.1), and separation using capillary pipettes. Bacteria can be eliminated from the phytoplankton culture by washing or plating in the presence of antibiotics. The sterility of the culture can be checked with a test tube containing sea water with 1 g.l^{-1} bactopectone. After sterilization, a drop of the culture to be tested is added and any residual bacteria will turn the bactopectone solution turbid.

The collection of algal strains should be carefully protected against contamination during handling and poor temperature regulation. To reduce risks, two series of stocks are often retained, one which supplies the starter cultures for the production system and the other which is only subjected to the handling necessary for maintenance. Stock cultures are kept in test tubes at a light intensity of about 1000 lux and a temperature of 16 to 19°C. Constant illumination is suitable for the maintenance of flagellates, but may result in decreased cell size in diatom stock cultures. Stock cultures are maintained for about a month and then transferred to create a new culture line (Fig. 2.4.).

2.3.4. Sources of contamination and water treatment

Contamination with bacteria, protozoa or another species of algae is a serious problem for monospecific/axenic cultures of micro-algae. The most common sources of contamination include the culture medium (sea water and nutrients), the air (from the air supply as well as the environment), the culture vessel, and the starter culture.

Seawater used for algal culture should be free of organisms that may compete with the unicellular algae, such as other species of phytoplankton, phytophagous zooplankton, or bacteria. Sterilization of the seawater by either physical (filtration, autoclaving, pasteurization, UV irradiation) or chemical methods (chlorination, acidification, ozonization) is therefore required. Autoclaving (15 to 45 min. at 120°C and 20 psi, depending on the volume) or pasteurization (80°C for 1-2 h) is mostly applied for sterilizing the culture medium in test tubes, erlenmeyers, and carboys. Volumes greater than 20 l are generally filtered at $1 \mu\text{m}$ and treated with acid (e.g. hydrochloric acid at pH 3, neutralization after 24 h with sodium carbonate) or chlorine (e.g. $1\text{-}2 \text{ mg.l}^{-1}$, incubation for 24 h without aeration, followed by aeration for 2-3 h to remove residual chlorine, addition of sodium thiosulfate to neutralize chlorine may be necessary if aeration fails to strip the chlorine). Water treatment is not required when using underground salt water obtained through bore holes. This water is generally free of living organisms and may contain sufficient mineral salts to support algal culture without further enrichment. In some cases well water contains high levels of ammonia and ferrous salts, the latter precipitating after oxidation in air.



Figure 2.4. Temperature controlled room for maintenance of algal stock cultures in a bivalve hatchery: stock cultures in test tubes (left) and inoculation hood (right).

A common source of contamination is the condensation in the airlines which harbor ciliates. For this reason, airlines should be kept dry and both the air and the carbon dioxide should be filtered through an in-line filter of 0.3 or 0.5 μm before entering the culture. For larger volumes of air, filter units can be constructed using cotton and activated charcoal (Fig.2.5.).

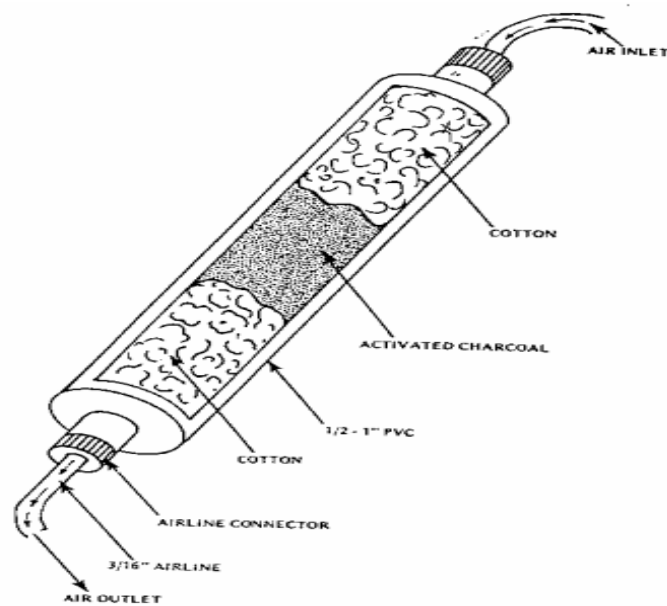

Figure 2.5. Aeration filter (Fox, 1983)

The preparation of the small culture vessels is a vital step in the upscaling of the algal cultures:

- wash with detergent
- rinse in hot water
- clean with 30% muriatic acid
- rinse again with hot water
- dry before use.

Alternatively, tubes, flasks and carboys can be sterilized by autoclaving and disposable culture vessels such as polyethylene bags can be used.

2.3.5. Algal culture techniques

Algae can be produced using a wide variety of methods, ranging from closely-controlled laboratory methods to less predictable methods in outdoor tanks. The terminology used to describe the type of algal culture include:

- **Indoor/Outdoor.** Indoor culture allows control over illumination, temperature, nutrient level, contamination with predators and competing algae, whereas outdoor algal systems make it very difficult to grow specific algal cultures for extended periods.
- **Open/Closed.** Open cultures such as uncovered ponds and tanks (indoors or outdoors) are more readily contaminated than closed culture vessels such as tubes, flasks, carboys, bags, etc.
- **Axenic (=sterile)/Xenic.** Axenic cultures are free of any foreign organisms such as bacteria and require a strict sterilization of all glassware, culture media and vessels to avoid contamination. The latter makes it impractical for commercial operations.
- **Batch, Continuous, and Semi-Continuous.** These are the three basic types of phytoplankton culture which will be described in the following sections.

Table 2.6. summarizes the major advantages and disadvantages of the various algal culture techniques.

Table 2.6. Advantages and disadvantages of various algal culture techniques (modified from Anonymous, 1991).

Culture type	Advantages	Disadvantages
Indoors	A high degree of control (predictable)	Expensive
Outdoors	Cheaper	Little control (less predictable)
Closed	Contamination less likely	Expensive
Open	Cheaper	Contamination more likely
Axenic	Predictable, less prone to crashes	Expensive, difficult
Non-axenic	Cheaper, less difficult	More prone to crashes
Continuous	Efficient, provides a consistent supply of high-quality cells, automation, highest rate of production over extended periods	Difficult, usually only possible to culture small quantities, complex, equipment expenses may be high
Semi-continuous	Easier, somewhat efficient	Sporadic quality, less reliable
Batch	Easiest, most reliable	Least efficient, quality may be inconsistent

2.3.5.1. Batch culture

The batch culture consists of a single inoculation of cells into a container of fertilized seawater followed by a growing period of several days and finally harvesting when the algal population reaches its maximum or near-maximum density. In practice, algae are transferred to larger culture volumes prior to reaching the stationary phase and the larger culture volumes are then brought to a maximum density and harvested. The following consecutive stages might be utilized: test tubes, 2 l flasks, 5 and 20 l carboys, 160 l cylinders, 500 l indoor tanks, 5,000 l to 25,000 l outdoor tanks (Figs.2.6., 2.7).

Table 2.7. Inoculation schedule for the continuous production of micro-algae using the batch technique. Every week a serial is initiated with 4 or 7 test tubes, depending on whether a new culture is required for harvesting every 2 days or daily.

Days	New culture available for harvest every 2 days				Harvest required daily							
1	t	t	t	t	t	t	t	t	t	t	t	t
2	t	t	t	t	t	t	t	t	t	t	t	t
3	t	t	t	t	t	t	t	t	t	t	t	t
4	t	t	t	t	t	t	t	t	t	t	t	t
5	t	t	t	t	t	t	t	t	t	t	t	t
6	t	t	t	t	t	t	t	t	t	t	t	t
7	t	t	t	t	t	t	t	t	t	t	t	t
8	e	e	e	e	e	e	e	e	e	e	e	e
9	e	e	e	e	e	e	e	e	e	e	e	e
10	e	e	e	e	e	e	e	e	e	e	e	e
11	e	e	e	e	e	e	e	e	e	e	e	e
12	E	e	e	e	E	e	e	e	e	e	e	e
13	E	e	e	e	E	E	e	e	e	e	e	e
14	E	E	e	e	E	E	E	e	e	e	e	e
15	E	E	e	e	E	E	E	E	e	e	e	e
16	f	E	E	e	f	E	E	E	E	e	e	e
17	f	E	E	e	f	f	E	E	E	E	e	e
18	f	f	E	E	f	f	f	E	E	E	E	E
19	f	f	E	E	f	f	f	f	E	E	E	E
20	F	f	f	E	F	f	f	f	f	E	E	E
21	F	f	f	E	F	F	f	f	f	f	E	E
22	F	F	f	f	F	F	F	f	f	f	f	f
23	F	F	f	f	F	F	F	F	f	f	f	f
24	L	F	F	f	L	F	F	F	F	f	f	f
25	L	F	F	f	L	L	F	F	F	F	f	f
26	*	L	F	F	*	L	L	F	F	F	F	F
27		L	F	F		*	L	L	F	F	F	F
28		*	L	F			*	L	L	F	F	F
29			L	F				*	L	L	F	F
30			*	L					*	L	L	L
31				L						*	L	L
32				*							*	L

t = 20 ml test tube

e = 250 ml erlenmeyer flask

E = 2 l erlenmeyer flask

f = 30 l fiberglass tank

F = 300 l fiberglass tank

L = use for larval feeding or to inoculate large volume (> 1.5 t) outdoor tanks

* = termination of 300 l fiberglass tank

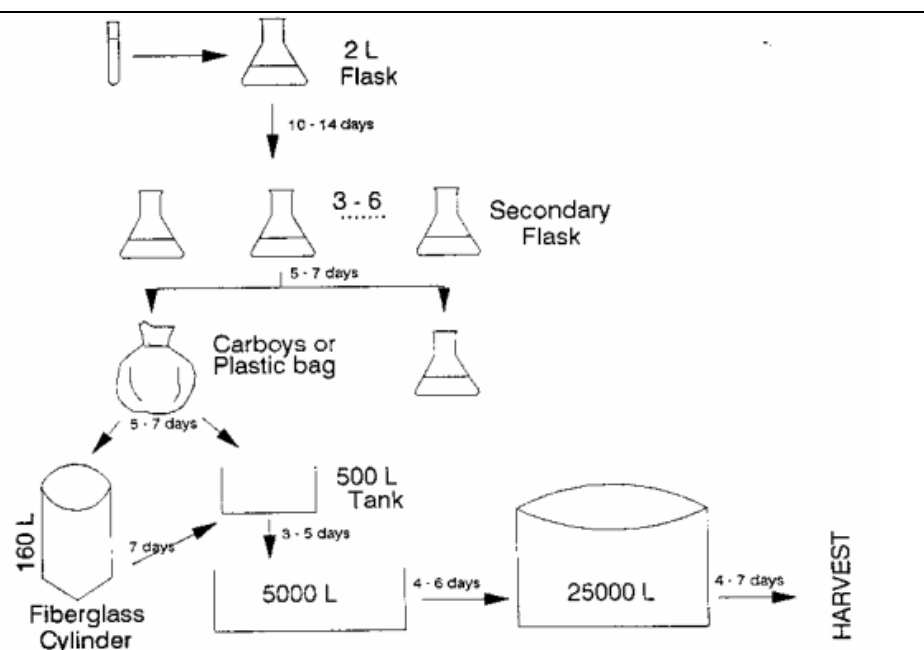

FIGURE 5. Progression of algal production at The Oceanic Institute.

Figure 2.6. Production scheme for batch culture of algae (Lee and Tamaru, 1993).

According to the algal concentration, the volume of the inoculum which generally corresponds with the volume of the preceding stage in the upscaling process, amounts to 2-10% of the final culture volume. An inoculation schedule for the continuous production according to the batch technique is presented in Table 2.7. Where small amounts of algae are required, one of the simplest types of indoor culture employs 10 to 20 l glass or plastic carboys (Fig. 2.8.), which may be kept on shelves backlit with fluorescent tubes (Fig. 2.9.).

Batch culture systems are widely applied because of their simplicity and flexibility, allowing to change species and to remedy defects in the system rapidly. Although often considered as the most reliable method, batch culture is not necessarily the most efficient method. Batch cultures are harvested just prior to the initiation of the stationary phase and must thus always be maintained for a substantial period of time past the maximum specific growth rate. Also, the quality of the harvested cells may be less predictable than that in continuous systems and for example vary with the timing of the harvest (time of the day, exact growth phase).

Another disadvantage is the need to prevent contamination during the initial inoculation and early growth period. Because the density of the desired phytoplankton is low and the concentration of nutrients is high, any contaminant with a faster growth rate is capable of outgrowing the culture. Batch cultures also require a lot of labour to harvest, clean, sterilize, refill, and inoculate the containers.



Figure 2.7.a. Batch culture systems for the mass production of micro-algae in 20,000 l tanks .



Figure 2.7.b. Batch culture systems for the mass production of micro-algae in 150 l cylinders.

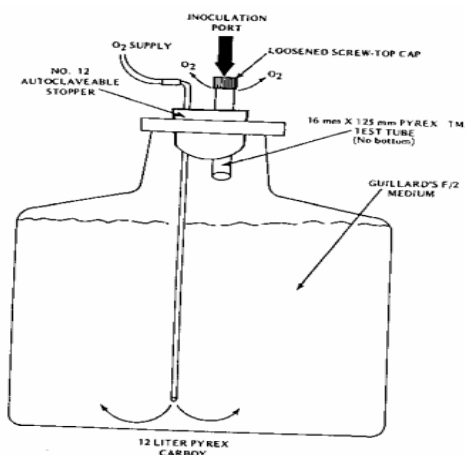

Figure 2.8. Carboy culture apparatus (Fox, 1983).

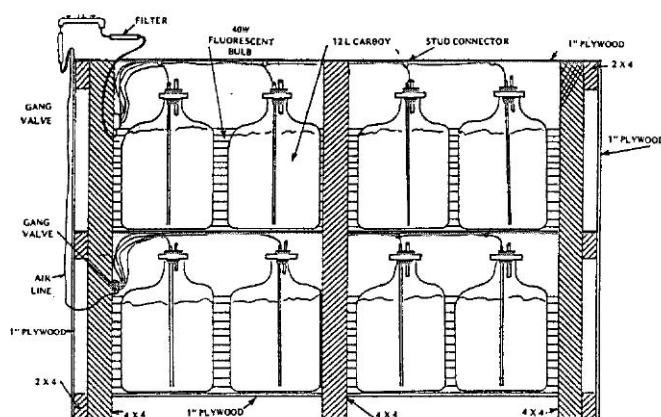

Figure 2.9. Carboy culture shelf (Fox, 1983).

2.3.5.2. Continuous culture

The continuous culture method, *i.e.* a culture in which a supply of fertilized seawater is continuously pumped into a growth chamber and the excess culture is simultaneously washed out, permits the maintenance of cultures very close to the maximum growth rate. Two categories of continuous cultures can be distinguished:

- turbidostat culture, in which the algal concentration is kept at a preset level by diluting the culture with fresh medium by means of an automatic system.
- chemostat culture, in which a flow of fresh medium is introduced into the culture at a steady, predetermined rate. The latter adds a limiting vital nutrient (*e.g.* nitrate) at a fixed rate and in this way the growth rate and not the cell density is kept constant.

Laing (1991) described the construction and operation of a 40 l continuous system suitable for the culture of flagellates, e.g. *Tetraselmis suecica* and *Isochrysis galbana* (Fig. 2.10.). The culture vessels consist of internally-illuminated polyethylene tubing supported by a metal framework (Fig. 2.11.). This turbidostat system produces 30-40 l per day at cell densities giving optimal yield for each flagellate species (Table 2.8.). A chemostat system that is relatively easy and cheap to construct is utilized by Seasalter Shellfish Co. Ltd, UK (Fig. 2.12.). The latter employ vertical 400 l capacity polyethylene bags supported by a frame to grow *Pavlova lutheri*, *Isochrysis galbana*, *Tetraselmis suecica*, *Phaeodactylum tricornutum*, *Dunaliella tertiolecta*, *Skeletonema costatum*. One drawback of the system is the large diameter of the bags (60 cm) which results in self-shading and hence relatively low algal densities.

The disadvantages of the continuous system are its relatively high cost and complexity. The requirements for constant illumination and temperature mostly restrict continuous systems to indoors and this is only feasible for relatively small production scales. However, continuous cultures have the advantage of producing algae of more predictable quality. Furthermore, they are amenable to technological control and automation, which in turn increases the reliability of the system and reduces the need for labor.

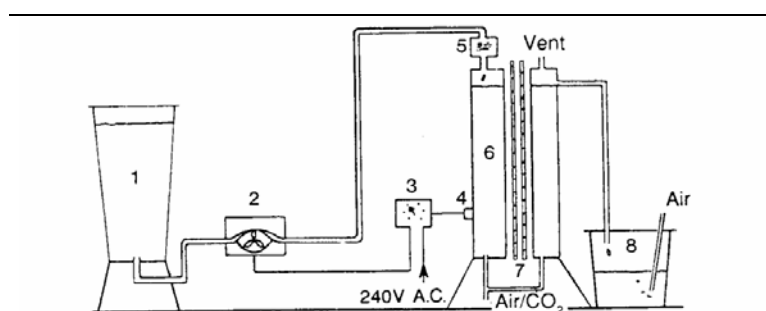

Figure 2.10. Diagram of a continuous culture apparatus (not drawn to scale): (1) enriched seawater medium reservoir (200 l); (2) peristaltic pump; (3) resistance sensing relay (50- 5000 ohm); (4) light-dependent resistor (ORP 12); (5) cartridge filter (0.45 μ m); (6) culture vessel (40 l); (7) six 80 W fluorescent tubes (Laing, 1991).

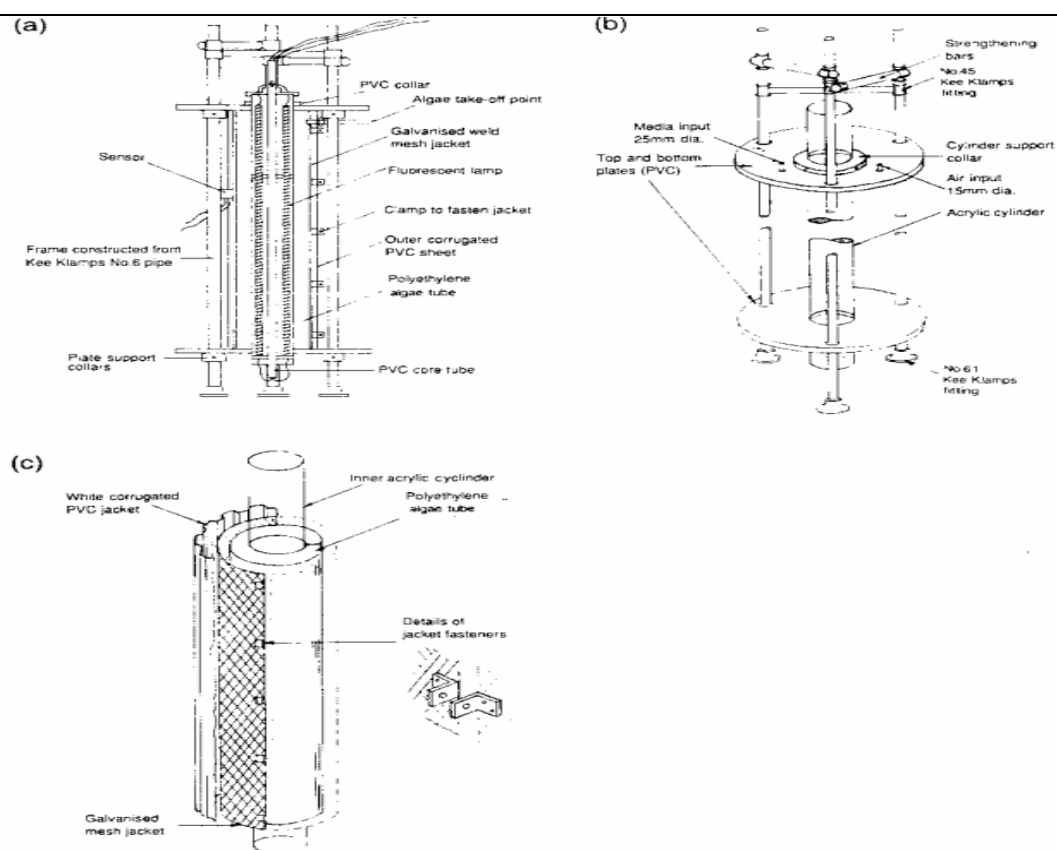

Figure 2.11. Schematic diagram of a 40 l continuous culture vessel (Laing, 1991).



Figure 2.12. Continuous culture of micro-algae in plastic bags. Detail (right) shows inflow of pasteurized fertilized seawater and outflow of culture.

Table 2.8. Continuous culture methods for various types of algae in 40 l internally-illuminated vessels (suitable for flagellates only) (modified from Laing, 1991),

Algae	Culture density for highest yield (cells per μ l)	Usual life of culture (weeks)
<i>Tetraselmis suecica</i>	2 000	3-6
<i>Chroomonas salina</i>	3 000	2-3
<i>Dunaliella tertiolecta</i>	4 000	3-4
<i>Isochrysis galbana</i> <i>Monochrysis lutheri</i> <i>Pseudoisochrysis paradoxa</i>	20 000	2-3

2.3.5.3. Semi-continuous culture

The semi-continuous technique prolongs the use of large tank cultures by partial periodic harvesting followed immediately by topping up to the original volume and supplementing with nutrients to achieve the original level of enrichment. The culture is grown up again, partially harvested, etc. Semi-continuous cultures may be indoors or outdoors, but usually their duration is unpredictable. Competitors, predators and/or contaminants and metabolites eventually build up, rendering the culture unsuitable for further use. Since the culture is not harvested completely, the semi-continuous method yields more algae than the batch method for a given tank size.

2.3.6. Algal production in outdoor ponds

Large outdoor ponds either with a natural bottom or lined with cement, polyethylene or PVC sheets have been used successfully for algal production. The nutrient medium for outdoor cultures is based on that used indoors, but agricultural-grade fertilizers are used instead of laboratory-grade reagents (Table 2.5). However, fertilization of mass algal cultures in estuarine ponds and closed lagoons used for bivalve nurseries was not found to be desirable since fertilizers were expensive and it induced fluctuating algal blooms, consisting of production peaks followed by total algal crashes. By contrast, natural blooms are maintained at a reasonable cell density throughout the year and the ponds are flushed with oceanic water whenever necessary. Culture depths are typically 0.25-1 m. Cultures from indoor production may serve as inoculum for monospecific cultures. Alternatively, a phytoplankton bloom may be induced in seawater from which all zooplankton has been removed by sand filtration. Algal production in outdoor ponds is relatively inexpensive, but is only suitable for a few, fast-growing species due to problems with contamination by predators, parasites and "weed" species of algae. Furthermore, outdoor production is often characterized by a poor batch to batch consistency and unpredictable culture crashes caused by changes in weather, sunlight or water quality.

Mass algal cultures in outdoor ponds are commonly applied in Taiwanese shrimp hatcheries where *Skeletonema costatum* is produced successfully in rectangular outdoor concrete ponds of 10-40 tons of water volume and a water depth of 1.5-2 m.

2.3.7. Culture of sessile micro-algae

Farmers of abalone (*Haliotis* sp.) have developed special techniques to provide food for the juvenile stages which feed in nature by scraping coralline algae and slime off the surface of rocks using their radulae. In culture operations, sessile micro-algae are grown on plates of corrugated roofing plastic, which serve as a substrate for the settlement of abalone larvae. After metamorphosis, the spat graze on the micro-algae until they become large enough to feed on macro-algae. The most common species of micro-algae used on the feeder plates are pennate diatoms (e.g. *Nitzschia*, *Navicula*). The plates are inoculated by placing them in a current of sand filtered seawater. Depending on local conditions, the micro-algae cultures on the plates take between one and three weeks to grow to a density suitable for settling of the larvae. As the spat grow, their consumption rate increases and becomes greater than the natural production of the micro-algae. At this stage, the animals are too fragile to be transferred to another plate and algal growth may be enhanced by increasing illumination intensity and/or by the addition of fertilizer.

2.3.8. Quantifying algal biomass

There are several ways to evaluate the quantity of algal biomass present in cultures either by counting the number of cells or through determination of volume, optical density or weight.

Cells can be counted either with an electronic particle counter or directly under a microscope, using a haematocytometer. The Coulter[®] counter and similar instruments need appropriate calibration for each algal species to be counted. Detailed instructions on operation of electronic cell counting can be found in Sheldon and Parsons (1967). The presence of contaminating particles in the same size range as the algae and failure of cells to separate after cell division may be possible sources of erroneous counts. Counting with a microscope has the advantage of allowing control of the quality of the cultures. The major difficulty in microscopic counts is reproducibility, which is a function of the sampling, diluting, and filling of the counting chamber, as well as the choice of the right type of counting chamber and range of cell concentration. Counting chambers, recommended for various cell sizes and concentrations, are listed in Table 2.9. Worksheet 2.2. details on the operation of two types of counting chambers, namely Fuchs-Rosenthal and Bürker.

A relationship between optical density and cellular concentration can be established using a spectrometer. However, variations may occur due to the fact that the chlorophyll concentration in the algal cell varies according to the culture conditions and therefore affects this relationship. In this way, a culture under low lighting conditions will be comparatively more pigmented and will eventually result in higher readings for optical density.

Table 2.9. Cell counting chambers and their properties (modified from Vonshak, 1986).

Commercial name of chamber	Chamber vol (ml)	Depth (mm)	Objective used for magnification	Cell size (mm)	Cell conc counted easily
Redgwick Rafter	1.0	1.0	2.5-10	50-100	$30 \cdot 10^4$
Palmer Malony	0.1	0.4	10-15	5-150	$10^2 \cdot 10^5$
Speirs Levy	$4 \cdot 10^3$	0.2	10-20	5-75	$10^4 \cdot 10^7$
Improved Neau-bouer	$2 \cdot 10^4$	0.1	20-40 (phase)	2-30	$10^4 \cdot 10^7$
Petroff Houser	$2 \cdot 10^5$	0.02	40-100	0.5-5	$10^4 \cdot 10^8$

Cellular volume is measured by centrifuging samples and measuring the volume of the concentrated paste.

Measuring the dry weight of a culture is one of the most direct ways to estimate biomass production. For this, the cells of a representative sample of the culture are separated from the culture medium by either centrifugation or filtration on a glassfiber filter. The cells of marine algae are washed with isotonic ammonium formate (0.5 M) to remove salts without causing the cells to burst. Ammonium formate does not leave any residues as it decomposes to volatile compounds during the drying process (e.g. 2 h at 100°C). The results can be expressed as dry weight per volume or, when combined with a determination of the cell concentration, per algal cell (see Worksheet 2.3.).

For a particular algal species, dry weight per cell may vary greatly according to the strain and culture conditions. Published data on the dry weight content for species commonly used in mariculture are presented in Table 2.10. The density of harvested algal cultures generally ranges between 80 and 250 mg of dry weight per liter.

Table 2.10. Cellular dry weight reported in literature for algal species commonly used in mariculture.

Algal species	Dry weight (pg cell ⁻¹)
<i>Isochrysis galbana</i>	8.0, 16.1, 20.1, 23.5, 30.5
<i>Isochrysis</i> sp. (clone, T-ISO)	14.1, 17.3, 29.7
<i>Skeletonema costatum</i>	52.2
<i>Thalassiosira pseudonana</i>	13.2, 17.8, 28.4
<i>Chaetoceros neogracile</i> (<i>C. gracilis</i>)	23.8, 30.6, 74.8
<i>Tetraselmis suecica</i>	66, 168, 194-244, 247, 292

2.3.9. Harvesting and preserving micro-algae

In most cases, it is unnecessary to separate micro-algae from the culture fluid. Excess and off-season production may, however, be concentrated and preserved. The various techniques employed to harvest micro-algae have been reviewed by Fox (1983) and Barnabé (1990). High-density algal cultures can be concentrated by either chemical flocculation or centrifugation. Products such as aluminum sulphate and ferric chloride cause cells to coagulate and precipitate to the bottom or float to the surface. Recovery of the algal biomass is then accomplished by, respectively, siphoning off the supernatant or skimming cells off the surface. Due to the increased particle size, coagulated algae are no longer suitable as food for filter-feeders. Centrifugation of large volumes of algal culture is usually performed using a cream separator; the flow rate being adjusted according to the algal species and the centrifugation rate of the separator. Cells are deposited on the walls of the centrifuge head as a thick algal paste, which is then resuspended in a limited volume of water. The resulting slurry may be stored for 1-2 weeks in the refrigerator or frozen. In the latter case, cryoprotective agents (glucose, dimethylsulfoxide) are added to maintain cell integrity during freezing. However, cell disruption and limited shelf-life remain the major disadvantages of long-term preserved algal biomass. Concentrated cultures of *Tetraselmis suecica* kept in darkness at 4°C maintain their viability, whereas the latter is completely lost upon freezing. Furthermore, cultures stored in hermetically sealed vials lose their viability more rapidly than those kept in cotton-plugged vials.

2.3.10. Algal production cost

Estimates of the algal production cost range from US\$ 4 to 300 per kg dry biomass (Table 2.11.). Algal production in outdoor ponds is relatively cheap, but is only suitable for a few, fast-growing species and is characterized by a poor batch-to-batch consistency and unpredictable culture crashes due to contaminations and/or fluctuating climatological conditions. Indoor algal production offers a better control of the culture conditions and the algal species being grown, but is more expensive than outdoor culture due to space, energy, and skilled labour requirements.

An international survey among the operators of bivalve hatcheries showed that only facilities capable of producing mass quantities of specific micro-algae are able to attain production costs below US\$ 100 per kg of dry weight (Fig. 2.13.).

Table 2.11. Production cost of marine micro-algae (modified from Coutteau and Sorgeloos, 1992).

Production cost (US\$.kg ⁻¹ dry weight)	Remarks	Source
300	<i>Tetraselmis suecica</i> 200 l batch culture	calculated from Helm <i>et al.</i> (1979)
167	various diatoms continuous flow cultures (240 m ³) ^a	calculated from Walsh <i>et al.</i> (1987)
4-20 160-200	outdoor culture indoor culture	De Pauw and Persoone (1988)
23-115	summer-winter production continuous flow cultures in bags (8 m ³) and tanks (150 m ³) ^a	Dravers (pers. comm. 1990)
50	tank culture (450 m ³) ^a	Donaldson (1991)
50 - 400	international survey among bivalve hatchery operators in 1991	Coutteau and Sorgeloos (1992)

^a total volume available for algal production

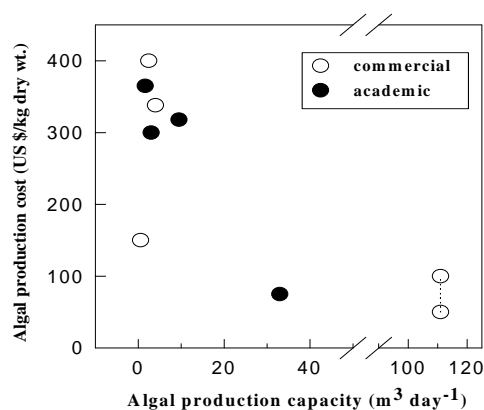

Figure 2.13. Algal production cost as a function of the production capacity for 8 bivalve hatcheries. Filled and unfilled symbols represent data obtained from academic and commercial hatcheries, respectively. The dotted line connects the estimates from one company (modified from Coutteau and Sorgeloos, 1992).

2.4. Nutritional value of micro-algae

The nutritional value of any algal species for a particular organism depends on its cell size, digestibility, production of toxic compounds, and biochemical composition. The gross composition of 16 species of micro-algae is compared in Table 2.12. Although there are marked differences in the compositions of the micro-algal classes and species, protein is always the major organic constituent, followed usually by lipid and then by carbohydrate. Expressed as percentage of dry weight, the range for the level of protein, lipid, and carbohydrate are 12-35%, 7.2-23%, and 4.6-23%, respectively.

The content of highly unsaturated fatty acids (HUFA), in particular eicosapentaenoic acid (20:5n-3, EPA), arachidonic acid (20:4n-6, ARA), and docosahexaenoic acid (22:6n-3, DHA), is of major importance in the evaluation of the nutritional composition of an algal species to be used as food for marine organisms. The fatty acid composition of 10 species of micro-algae grown under defined conditions and harvested during the log phase is presented in Fig. 2.14. Significant concentrations of EPA are present in the diatom species (*Chaetoceros calcitrans*, *C. gracilis*, *S. costatum*, *T. pseudonana*) and the prymnesiophyte *Platymonas lutheri*, whereas high concentrations of DHA are found in the prymnesiophytes (*P. lutheri*, *Isochrysis* sp.) and *Chroomonas salina*.

Micro-algae can also be considered as a rich source of ascorbic acid (0.11-1.62% of dry weight, Fig. 2.15.).

The nutritional value of micro-algae can vary considerably according to the culture conditions. For example the effect of the composition of the culture medium on the proximate composition of various species of micro-algae is demonstrated in Table 2.13.

Table 2.12. Concentrations of chlorophyll a, protein, carbohydrate and lipid in 16 species of micro-algae commonly used in aquaculture (modified from Brown, 1991).

Algal class Species	Dry weight (pg.cell ⁻¹)	Chl a	Protein	Carbo- hydrate	Lipid
Weight of constituent (pg.cell ⁻¹)					
Bacillariophyceae					
<i>Chaetoceros calcitrans</i>	11.3	0.34	3.8	0.68	1.8
<i>Chaetoceros gracilis</i>	74.8	0.78	9.0	2.0	5.2
<i>Nitzschia closterium</i>	-	-	-	-	-
<i>Phaeodactylum tricornutum</i>	76.7	0.41	23.0	6.4	10.7
<i>Skeletonema costatum</i>	52.2	0.63	13.1	2.4	5.0
<i>Thalassiosira pseudonana</i>	28.4	0.27	9.7	2.5	5.5
Chlorophyceae					
<i>Dunaliella tertiolecta</i>	99.9	1.73	20.0	12.2	15.0
<i>Nannochloris atomus</i>	21.4	0.080	6.4	5.0	4.5
Cryptophyceae					
<i>Chroomonas salina</i>	122.5	0.98	35.5	11.0	14.5
Eustigmatophyceae					
<i>Nannochloropsis oculata</i>	6.1	0.054	2.1	0.48	1.1
Prasinophyceae					
<i>Tetraselmis chui</i>	269.0	3.83	83.4	32.5	45.7
<i>Tetraselmis suecica</i>	168.2	1.63	52.1	20.2	16.8
Prymnesiophyceae					
<i>Isochrysis galbana</i>	30.5	0.30	8.8	3.9	7.0
<i>Isochrysis</i> aff. <i>Galbana</i> (T-iso)	29.7	0.29	6.8	1.8	5.9
<i>Pavlova lutheri</i>	102.3	0.86	29.7	9.1	12.3
<i>Pavlova salina</i>	93.1	0.34	24.2	6.9	11.2
Percentage of dry weight					
Bacillariophyceae					
<i>Chaetoceros calcitrans</i>	11.3	3.01	34	6.0	16
<i>Chaetoceros gracilis</i>	74.8	1.04	12	4.7	7.2
<i>Nitzschia closterium</i>	-	-	26	9.8	13
<i>Phaeodactylum tricornutum</i>	76.7	0.53	30	8.4	14
<i>Skeletonema costatum</i>	52.2	1.21	25	4.6	10
<i>Thalassiosira pseudonana</i>	28.4	0.95	34	8.8	19
Chlorophyceae					
<i>Dunaliella tertiolecta</i>	99.9	1.73	20	12.2	15
<i>Nannochloris atomus</i>	21.4	0.37	30	23.0	21
Cryptophyceae					
<i>Chroomonas salina</i>	122.5	0.80	29	9.1	12
Eustigmatophyceae					
<i>Nannochloropsis oculata</i>	6.1	0.89	35	7.8	18

Table 2.12.(contd.) Concentrations of chlorophyll a, protein, carbohydrate and lipid in 16 species of micro-algae commonly used in aquaculture (modified from Brown, 1991).

Algal class Species	Dry weight (pg.cell ⁻¹)	Chl a	Protein	Carbo- hydrate	Lipid
Prasinophyceae					
<i>Tetraselmis chui</i>	269.0	1.42	31	12.1	17
<i>Tetraselmis suecica</i>	168.2	0.97	31	12.0	10
Prymnesiophyceae					
<i>Isochrysis galbana</i>	30.5	0.98	29	12.9	23
<i>Isochrysis</i> aff. <i>Galbana</i> (T-iso)	29.7	0.98	23	6.0	20
<i>Pavlova lutheri</i>	102.3	0.84	29	9.0	12
<i>Pavlova salina</i>	93.1	0.98	26	7.4	12

The protein content per cell, which is considered as one of the most important factors determining the nutritional value of micro-algae as feed in aquaculture, was found to be more susceptible to medium-induced variation than the other cellular constituents.

Moreover, the growth of animals fed a mixture of several algal species is often superior to that obtained when feeding only one algal species. A particular alga may lack a nutrient, while another alga may contain that nutrient and lack a different one. In this way, a mixture of both algal species supplies the animals with an adequate amount of both nutrients. An extensive review of the nutritional aspects of micro-algae used in mariculture of bivalve molluscs, crustaceans, and fish is presented in Brown *et al.* (1989).

Table 2.13. Cellular density (10^6 cells.ml⁻¹) and proximate composition (pg.cell⁻¹) of four marine micro-algae grown in different culture media (Algal-1 is a commercial nutrient) (modified from Herrero *et al.*, 1991)

	Cellular density	Protein	Carbohydrates	Lipids
<i>T. suecica</i>				
Walne	2.29	13.31	6.20	7.04
ES	2.58	16.98	6.93	7.22
F/2	2.38	21.75	8.37	7.92
Algal-1	4.11	32.22	8.83	8.65
<i>D. tertiolecta</i>				
Walne	4.04	13.37	13.22	22.28
ES	4.24	14.88	15.73	23.94
F/2	4.97	13.26	17.91	23.67
Algal-1	8.45	18.82	11.08	18.18
<i>I. galbana</i>				
Walne	10.11	5.17	4.28	25.95
ES	12.09	7.23	5.21	28.38
F/2	10.81	8.13	5.59	26.82
Algal-1	16.15	9.57	4.28	20.68
<i>P. tricornutum</i>				
Walne	19.01	2.65	6.42	6.51
ES	16.23	5.21	9.20	6.45
F/2	24.65	3.34	6.90	5.52
Algal-1	39.04	4.20	5.98	5.79

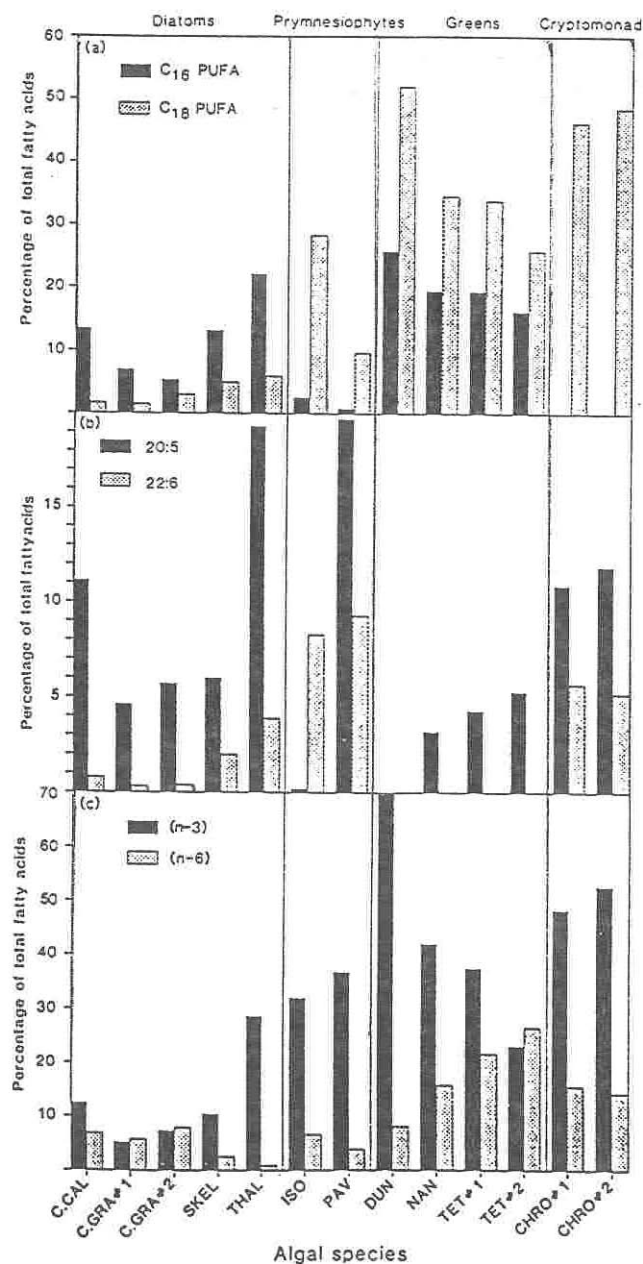

Figure 2.14. Fatty acid composition of 10 species of micro-algae. Relative amounts of (a) C₁₆- and C₁₈-polyunsaturated fatty acids (PUFA); (b) 20:5_{n-3} and 22:6_{n-3}; (c) (n-3) and (n-6) PUFA. Species abbreviations are: C. CAL: *Chaetoceros calcitrans*; C.GRA: *C. gracilis*; SKEL: *Skeletonema costatum*; THAL: *Thalassiosira pseudonana*; ISO: *Isochrysis* sp. (Tahitian); PAV: *Pavlova lutheri*; DUN: *Dunaliella tertiolecta*; NAN: *Nannochloris atomus*; TET: *Tetraselmis suecica*; CHRO: *Chroomonas salina* (Volkman et al., 1989).

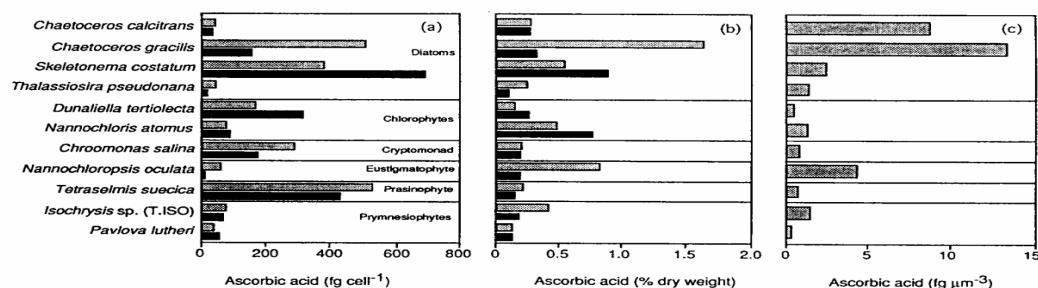

Figure 2.15. Ascorbic acid in microalgae harvested from logarithmic (grey filling) and stationary phase (black filling) cultures, expressed as (a) cellular levels ($\text{fg}\cdot\text{cell}^{-1}$), (b) % dry weight, (c) concentrations ($\text{fg}\cdot\mu\text{m}^{-3}$) (Brown and Miller, 1992).

2.5. Use of micro-algae in aquaculture

Micro-algae are an essential food source in the rearing of all stages of marine bivalve molluscs (clams, oysters, scallops), the larval stages of some marine gastropods (abalone, conch), larvae of several marine fish species and penaeid shrimp, and zooplankton.

2.5.1. Bivalve molluscs

Intensive rearing of bivalves has so far relied on the production of live algae, which comprises on average 30% of the operating costs in a bivalve hatchery. The relative algal requirements of the various stages of the bivalve culture process depend on whether the operation aims at the mass-production of larvae for remote setting or growing millions of seed till planting size. In either case, the juveniles, representing the largest biomass in the hatchery and demanding the highest weight-specific rations, consume the largest volumes of algal culture (Fig. 2.16.). The algal species that were reported in an international survey among hatchery operators in 1991 are listed in Table 2.14. Eight algal species (*Isochrysis* sp., clone T-Iso; *C. gracilis*; *C. calcitrans*; *T. suecica*; *T. pseudonana*, clone 3H; *P. lutheri*; *I. galbana*; *S. costatum*) were widely used and represented over 90% of the volume of algal culture produced in 23 facilities.

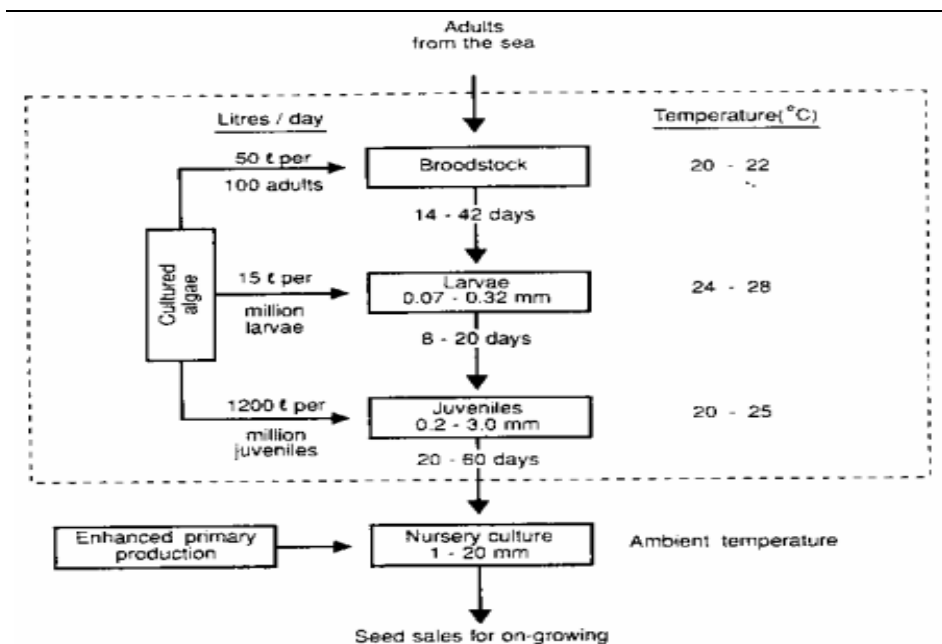

Figure 2.16. Requirements for cultured algae in hatchery and nursery culture of bivalve molluscs (Utting and Spencer, 1991).

Table 2.14. Algal species used in hatchery and nursery rearing of bivalve molluscs as reported in an international questionnaire. Species are ranked according to decreasing frequency of use (Coutteau and Sorgeloos, 1992).

Algal species	frequency of use [†]	total production n [‡]	daily production volume (m ³)
<i>Isochrysis</i> sp., clone T-Iso	31	18	23.8
<i>Chaetoceros gracilis</i>	23	11	14.1
<i>Chaetoceros calcitrans</i>	16	10	6.0
<i>Tetraselmis suecica</i>	15	10	39.1
<i>Thalassiosira pseudonana</i> , clone 3H	14	9	112.0
<i>Pavlova lutheri</i>	11	7	11.7
<i>Isochrysis galbana</i>	8	5	9.1
<i>Skeletonema costatum</i>	6	3	58.8
<i>Chroomonas salina</i>	5	3	0.76
<i>Dunaliella tertiolecta</i>	4	2	2.2

Table 2.14. (contd.) Algal species used in hatchery and nursery rearing of bivalve molluscs as reported in an international questionnaire. Species are ranked according to decreasing frequency of use (Coutteau and Sorgeloos, 1992)

<i>Chaetoceros simplex</i>	3	3	1.76
<i>Chaetoceros muelleri</i>	3	2	5.0
<i>Nannochloropsis sp.</i>	3	2	0.20
<i>Cyclotella sp.</i>	2	1	0.36
<i>Phaeodactylum tricornutum</i>	2	1	2.0
<i>Tetraselmis chui</i>	2	0	-
<i>Pavlova salina</i>	1	1	3.18
<i>Dicruteria sp.</i>	1	1	4.07
<i>Tetraselmis levis</i>	1	0	-
<i>Dunaliella perva</i>	1	1	0.012
<i>Thalassiosira weissflogii</i>	1	1	0.12
<i>Chlamydomonas sp.</i>	1	1	0.52
<i>Chlorella sp.</i>	1	1	0.36
TOTAL	43	23	295

†: number of hatcheries growing each algal species (from 43 completed forms)
‡: number of hatcheries providing data which allowed to calculate daily production per algal species (from 23 completed forms)

The larvae of most bivalve species have similar food preferences; suitable algal species including *C. calcitrans*, *T. pseudonana* (3H), *I. galbana*, and *T. suecica* (for larvae > 120 µm in length). Combinations of flagellates and diatoms provide a well balanced diet which will generally accelerate the rate of larval development to metamorphosis in comparison with unialgal diets. The quantity fed depends upon the larval density, but suitable cell concentrations (expressed as cells.µl⁻¹) are given by each of the following combinations:

- *I. galbana*; 50
- *C. calcitrans*; 250
- *I. galbana*/*C. calcitrans*; 25/125
- *I. galbana*/*C. calcitrans*/*T. suecica*; 33/83/3.3 (larvae > 120µm)

Because of the high cost of cultured algae, bivalve hatcheries prefer to move juveniles to outdoor nursery systems at a maximum size of 1-2 mm length. In this way, the duration of the juvenile phase in closely controlled hatchery conditions is relatively short for oysters at about 20 days but much longer for the slower growing clams at up to 60 days. Bivalve food rations are preferentially expressed as daily weight-specific rations, such as number of cells or percent dry weight of algae per live weight of bivalves. Seed growth is largely influenced by food ration and the optimal ration for maximum growth depends upon the species and culture conditions of the algae making up the diet, and the bivalve culture conditions. Under practical hatchery conditions, high food rations are often fed, which may be as high as 5-6% dry weight of algae per live weight of spat per day.

2.5.2. Penaeid shrimp

A typical algal feeding regime for penaeid larvae is given in Table 2.15. Algae are added during the non-feeding nauplius stage so that algae are available immediately upon molting into the protozoa stage. Algal species most often used are *Tetraselmis chui*, *Chaetoceros gracilis*, and *Skeletonema costatum*. As feeding preference changes from primarily herbivorous to carnivorous during the mysis stages, the quantity of algae is reduced. Nevertheless, a background level of algae is maintained as this may stabilize water quality. The "same-tank method", in which the algae are cultured in the same water as that of the larvae using sunlight and fertilizers, was originally developed in Japan for culturing larval *Penaeus japonicus* and is extensively described by Liao *et al.* (1993).

Table 2.15: Typical algal feeding regimes (cells.ml⁻¹) for penaeid larvae (N: nauplius, P: protozoa, M: mysis, PL: postlarva stage) (modified from Smith *et al.*, 1993b).

Substage	<i>Chaetoceros neogracile</i> (<i>C. gracilis</i>)	<i>Tetraselmis chuii</i>
N ₅ or N ₆	60,000	0-15,000
P ₁	100,000-120,000	30,000
P ₂	120,000	35,000
P ₃	120,000	35,000
M ₁	100,000	30,000
M ₂	75,000	20,000
M ₃	50,000-75,000	20,000
PL ₁ to PL ₅	20,000-75,000	5,000-20,000

2.5.3. Marine fish

Apart from the requirement for micro-algae for culturing and/or enriching live prey organisms such as *Artemia* and rotifers (see Chapters 3. and 4.3.), algae are often used directly in the tanks for rearing marine fish larvae. This "green water technique" is part of the commonly applied techniques for rearing larvae of gilthead seabream *Sparus aurata* (50,000 cells ml⁻¹ of *Isochrysis* sp. + 400,000 cells.ml⁻¹ of *Chlorella* sp. per day), milkfish *Chanos chanos* (between 500 and 3,500 *Chlorella* cells.ml⁻¹ are added from hatching till day 21), Mahimahi *Coryphaena hippurus* (200,000 cells.ml⁻¹ of either *Chaetoceros gracilis*, *Tetraselmis chui*, or

Chlorella sp.), halibut *Hippoglossus hippoglossus* (*Tetraselmis* sp.), and turbot *Scophthalmus maximus* (60,000 cells.ml⁻¹ of *Tetraselmis* sp. or 130,000 cells.ml⁻¹ of *I. galbana*).

The effects of the presence of micro-algae in the larval rearing tank are still not fully understood and include:

- stabilizing the water quality in static rearing systems (remove metabolic by-products, produce oxygen);
- a direct food source through active uptake by the larvae with the polysaccharides present in the algal cell walls possibly stimulating the non-specific immune system in the larvae;
- an indirect source of nutrients for fish larvae through the live feed (i.e. by maintaining the nutritional value of the live prey organisms in the tank);
- increasing feeding incidence by enhancing visual contrast and light dispersion, and
- microbial control by algal exudates in tank water and/or larval gut.

2.6. Replacement diets for live algae

The high costs associated with algal production, the risks for contamination, and temporal variations in the algal food value still pose problems for any aquaculture operation depending on the mass-cultures of unicellular algae. In order to overcome or reduce the problems and limitations associated with algal cultures, various investigators have attempted to replace algae by using artificial diets either as a supplement or as the main food source. Different approaches are being applied to reduce the need for on-site algal production, including the use of preserved algae, micro-encapsulated diets, and yeast-based feeds.

To date, the requirement for live algae in the mass-production of prey-organisms has been largely reduced. In this way, baker's yeast, marine yeasts and lipid-enriched yeast diets are now routinely used as a sole diet or in combination with the alga *Chlorella* for rearing the rotifer *B. plicatilis* (see Chapter 3). In addition, considerable progress has been made in the replacement of live algae in the larval rearing of commercially important shrimp species. Partial replacement of live algae using micro-encapsulated and yeast-based diets is now routine in hatcheries for penaeid shrimp. Complete substitution of live algae by a commercial micro-encapsulated diet has been accomplished recently for the production of various penaeid species using seawater filtered to 5 µm, eliminating the algae but not the bacteria, which apparently contribute important micronutrients (and possibly immunostimulants). In marine fish hatcheries, the tendency is to apply a "clear water technique" instead of a "green water technique". However, the omission of algae in the larval tanks, which requires optimization of feeding strategies and zootechnical aspects, still often results in less predictable culture performance. Despite extensive research efforts, the use of artificial diets in the culture of bivalve molluscs is still very limited. The advantages and disadvantages of each of the three classes of replacement diets for live algae are briefly discussed below.

2.6.1. Preserved algae

A possible alternative to on-site algal culture could be the distribution of preserved algae that are produced at relatively low cost in a large facility under optimal climatological conditions and using the most cost-effective production systems. Centrifugation of algae into a paste form and subsequent refrigeration until required is widely applied in North America by oyster hatcheries using remote setting techniques. However, the limited shelf-life and/or the high prices of the presently available algal pastes (US\$ 200 or more per kg dry weight) have discouraged many growers from using them. Recently, the development of preservation techniques has extended the shelf-life of *Thalassiosira pseudonana* concentrates from about 10 days to more than one year, which makes it possible to utilize excess and off-season algal production. Outdoor pond production on a large scale has led to the bulk availability of a limited number of "algal meals", such as spray-dried *Spirulina* and a spray-dried extract of *Dunaliella salina*. The latter may be used as a supplement to live algae to improve the growth of bivalve larvae.

In addition, recent techniques have been developed for the large scale production of marine micro-algae under heterotrophic growth conditions, by utilizing organic carbon instead of light as an energy source. Heterotrophic algal cultures can attain up to 1,000 times higher densities than photoautotrophic cultures and can be preserved by spray-drying. Projected costs of producing algae within industrial fermentors vary from US\$ 5 to 25 per kg (Gladue, 1991). Unfortunately, heterotrophic mass-production techniques have only been realized for a few algal species, and most of the species that are known to be of high nutritional value (e.g. *Chaetoceros*, *Isochrysis*, *Skeletonema*, *Thalassiosira*, *Monochrysis*) are not capable of growing in the dark. Furthermore, heterotrophic conditions may result in a drastic change in the gross composition and reduced (n-3) HUFA content as compared to light-grown algae. Nevertheless, further developments in this rather new technology may improve the biochemical composition and the range of dried algae available in the future.

2.6.2. Micro-encapsulated diets

Through micro-encapsulation techniques dietary ingredients can be encapsulated within digestible capsules and delivered to suspension-feeders without losses of nutrients to the aqueous medium. Possible problems arising from the use of microparticulate feeds include settling, clumping and bacterial degradation of the particles, leaching of nutrients, and low digestibility of the cell wall material. In this regard, low susceptibility to bacterial attack and high digestibility for the filter-feeder may be conflicting requirements for a capsule wall.

2.6.3. Yeast-based diets

Because of their suitable particle size and high stability in the water column yeasts can easily be removed from suspension and ingested by filter-feeding organisms. Furthermore, as opposed to most of the other alternatives to live algae, yeasts can be mass-produced at a relatively low cost. The potential of yeasts as a food in aquaculture has been proven by their successful application in the rearing of rotifers and some species of penaeid shrimp. However, a limited nutritional value of yeasts was reported for various species of filter-feeders and attributed to their nutritionally deficient composition and/or undigestible cell wall. Despite this, the nutritional value and digestibility of yeast-based diets can be improved through the addition of limiting essential nutrients and the chemical treatment of the yeast

cell wall, respectively. In this way, about 50% of the algae can be substituted by yeast-based diets with minimal effects on the growth of juvenile hard clam, *Mercenaria mercenaria* (Coutteau *et al.*, 1994).

2.7. Literature of interest

Anonymous, 1991. The design and operation of live feeds production systems. In: Rotifer and micro-algae culture systems, Fulks, W. and Main K.L. (Eds.). Proceedings of a US-Asia Workshop, Honolulu, Hawaii, January 28-31, 1991 The Oceanic Institute, Hawaii, USA, pp 3-52.

Barnabé, G. 1990. Harvesting micro-algae. In: Aquaculture, Volume I. Barnabé, G. (Ed.). Ellis Horwood, New York, pp 207-212.

Brown, M.R., Jeffrey, S.W. and Garland, C.D. 1989. Nutritional aspects of microalgae used in mariculture; a literature review, CSIRO Marine Laboratories Report 205, 44 pp.

Brown, M.R. 1991. The amino acid and sugar composition of 16 species of microalgae used in mariculture. *Aquaculture*, 145: 79-99.

Brown, M.R. and Miller, K.A. 1992. The ascorbic acid content of eleven species of microalgae used in mariculture. *J. Appl. Phycol.*, 4: 205-215.

Coutteau, P. and Sorgeloos, P. 1992. The requirement for live algae and their replacement by artificial diets in the hatchery and nursery rearing of bivalve molluscs: an international survey. *J. Shellfish Res.*, 11(2): 467-476.

Coutteau, P., Hadley, N., Manzi, J. and Sorgeloos, P. 1994. Effect of algal ration and substitution of algae by manipulated yeast diets on growth of juvenile *Mercenaria mercenaria*. *Aquaculture*, 120: 135-150.

De Pauw, N. and Persoone, G. 1988. Micro-algae for aquaculture. In: Micro-algal Biotechnology. Borowitzka, M.A. and L.J. Borowitzka (Eds.). Cambridge University Press, Cambridge, U.K., pp 197-221.

Donaldson, J. 1991. Commercial production of microalgae at Coast Oyster Company. In: Rotifer and microalgae culture systems, Proceedings of a US-Asia Workshop, Honolulu, Hawaii, January 28-31, 1991. Fulks, W. and K.L. Main (eds). The Oceanic Institute, Hawaii, USA, pp 229-236.

Fox, J.M. 1983. Intensive algal culture techniques. In: CRC Handbook of mariculture. Volume 1. Crustacean Aquaculture. McVey J P (Ed.). CRC Press, Inc., Boca Raton, Florida, USA, pp 43-69.

Gladue, R. 1991. Heterotrophic microalgae production: Potential for application to aquaculture feeds. In: Rotifer and microalgae culture systems, Proceedings of a US-Asia Workshop, Honolulu, Hawaii, January 28-31, 1991. Fulks, W and K.L. Main (eds). The Oceanic Institute, Hawaii, USA, pp 276-286.

Helm, M.M., Laing I., and Jones, E. 1979. Culture of algae for larval fish and shellfish rearing. Part 1. The development of a 200 l algal culture vessel at Conwy, Fisheries Research Technical Report, MAFF Direct. Fish. Res., Lowestoft (53), UK, 18 pp.

- Herrero, C., C. Angeles, J. Fabregas, and J. Abalde 1991. Yields in biomass and chemical constituents of four commercially important marine microalgae with different culture media. *Aquacult. Eng.*, 10: 99-110.
- Laing, I. 1991. Cultivation of marine unicellular algae. MAFF Laboratory Leaflet Number 67. Directorate of Fisheries Research Lowestoft, UK. 31pp.
- Lee, C-S and Tamaru, C.S. 1993. Live larval food production at the Oceanic Institute, Hawaii. In: *CRC Handbook of mariculture. Volume 1. Crustacean Aquaculture, 2nd Edition.* McVey J.P. (Ed.). CRC Press, Inc., Boca Raton, Florida, USA, pp 15-28.
- Liao, I., Su, H.-S. and Lin, J.-H 1993. Larval foods for penaeid prawns. In: *CRC Handbook of mariculture. Volume 1. Crustacean Aquaculture, 2nd Edition.* McVey J.P. (Ed.). CRC Press, Inc., Boca Raton, Florida, USA, pp 29-59.
- Palanisamy, V., Latif, F.A. and Resat, R.B.M. 1991. A guide on the production of algal culture for use in shrimp hatcheries. National Prawn Fry Production and Research Centre, Pulau Sayak, Kedah, Department of Fisheries, Ministry of Agriculture, Malaysia. 23pp.
- Sheldon, R.W. and Parsons T.R. 1967. A practical manual on the use of the Coulter counter in marine research. Coulter Electronics Sales Company, Ontario, Canada, 65 pp.
- Smith, L.L., Fox, J.M. and Granvil, D.R. 1993a. Intensive algae culture techniques. In: *CRC Handbook of mariculture. Volume 1. Crustacean Aquaculture, 2nd Edition.* McVey J.P. (Ed.). CRC Press, Inc., Boca Raton, Florida, USA, pp 3-13.
- Smith, L.L., Fox, J.M. and Granvil, D.R. 1993b. Intensive larviculture techniques. In: *CRC Handbook of mariculture. Volume 1. Crustacean Aquaculture, 2nd Edition.* McVey J.P. (Ed.). CRC Press, Inc., Boca Raton, Florida, USA, pp 153-172.
- Utting, S.D. and Spencer, B.E. 1991. The hatchery culture of bivalve mollusc larvae and juveniles. MAFF Laboratory Leaflet Number 68. Directorate of Fisheries Research, Lowestoft, UK. 31pp.
- Volkman, J.K., Jeffrey, S.W., Nichols, P.D, Rogers, G.I. and Garland, C.D. 1989. Fatty acids and lipid classes of ten species of microalgae used in mariculture. *J. Exp. Mar. Biol. Ecol.*, 128: 219-240.
- Vonshak, A. 1986. Laboratory techniques for the cultivation of microalgae. In: *CRC Handbook of microalgal mass culture.* Richmond A. (Ed.). CRC Press, Inc., Boca Raton, Florida, USA, pp 117-145.
- Walsh, D.T., Withstandley, C.A., Kraus, R.A., and Petrovits, B.J. 1987. Mass culture of selected marine microalgae for the nursery production of bivalve seed. *J. Shellfish Res.*, 6: 71-77.

2.8 WORKSHEETS

WORKSHEET 2.1. : ISOLATION OF PURE ALGAL STRAINS BY THE AGAR PLATING TECHNIQUE

The following agar plating technique can be used to isolate algal strains from raw seawater and for the maintenance of existing algal strains.

- prepare a 0.9% agar medium by weighing out 9 g of agar powder and placing it into a 2 l conical flask to which 1 l of sea water is added
- heat the flask on a Bunsen flame and let it boil twice, i.e. heat until it boils, let it cool and let it boil a second time.
- add nutrients (see Tables 2.3 & 2.4) before autoclaving
- cover the flask with aluminium foil
- autoclave at 125 °C for 30 minutes at 1 atm
- sterilise Petridishes by incubation for 30 minutes at 150°C
- agar plates are prepared aseptically by pouring the warm autoclaved agar into the sterile Petridishes near a Bunsen flame or in a laminar flow, cover up the Petridishes and leave them to cool for about 2 h
- streak the algal sample onto the agar surface with a sterile platinum loop (previously heated to red-hot and cooled)
- place the Petri dishes upside-down on an illuminated glass rack
- depending on the density of the inoculum, cell colonies can be observed to grow on the surface after 5 - 21 days
- select the best colonies and transfer them with a sterile platinum loop into a test tube filled with 5-10 ml of culture medium and shake it regularly during incubation on an illuminated glass rack.
- when a colour change is observed in the tube, check under the microscope the isolated algal strain

WORKSHEET 2.2. : DETERMINATION OF CELL CONCENTRATIONS USING HAEMATOCYTOMETER ACCORDING TO FUCHS-ROSENTHAL AND BURKER.

A variety of counting chambers (normally used for blood cell counts) can be used for cell counts (algae, yeast) (see Table 2.9.). Two types are most common: Fuchs-Rosenthal and Bürker (Fig. 2.17.). Both types have 2 rafters allowing for 2 subsamples to be examined. They have the following characteristics :

	Fuchs - Rosenthal	Bürker
Depth (in mm)	0.200	0.100
Surface of smallest square (in mm ²)	0.0625	0.0400
minimal cell concentration (in cells.ml ⁻¹)	10 ³	10 ⁶

- dilute sample if needed (use formalin 4% to fixate moving algal cells)
clean slide and cover-glass with Kleenex-paper
- press cover glass onto the slide until the Newton diffraction rings appear
- fill both slides of the counting chamber under the cover-glass with a single smooth flow of suspension using a Pasteur pipet (avoid air bubbles)
- count cells in, respectively, 80 (Fuchs-Rosenthal) and 20 (Bürker) small squares under a microscope (objective 40 x). Count cells which touch the upper and left border but not those which touch the lower and right borders (see schematic diagram)
- the subsample on the other side of the chamber is counted in the same way
- calculation for Fuchs-Rosenthal
numbers of cells.ml⁻¹ = $(n_1 + n_2)/(2 \times 80) \times 80 \times 10^3 \times d = (n_1 + n_2)/2 \times 10^3 \times d$
- calculation for Bürker
numbers of cells.ml⁻¹ = $(n_1 + n_2)/(2 \times 20) \times 250 \times 10^3 \times d = (n_1 + n_2)/160 \times 10^6 \times d$
with : n_1 = number of cells counted in upper rafter
 n_2 = number of cells counted in lower rafter
 d = dilution factor
- For greater accuracy make 3 duplicate counts (3 separate dilutions each counted in two rafters).

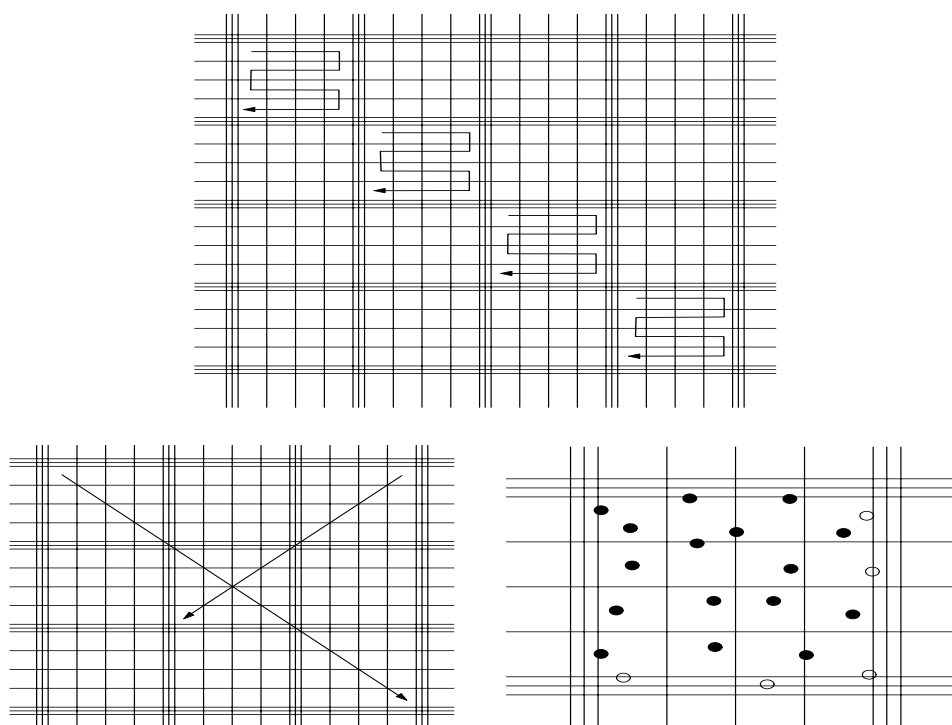

Figure 2.17. Counting directions (follow arrow) for Fuchs-Rosenthal chamber (upper diagram) and for Bürker (down left corner). For both, count the cells in the square and those which touch the top and left border (●). Do not count the ones touching the right and lower border (○) (see down right corner).

WORKSHEET 2.3. : CELLULAR DRY WEIGHT ESTIMATION OF MICRO-ALGAE.

Dry weight of algal cells can be determined by filtering and drying algae from aliquots of culture of known concentration

- determine accurately (3 duplicate counts, see Worksheet 2.2.) the concentration of the algal culture to be sampled for dry weight analysis
- filter an exact volume of culture on pretared glass-fiber filters (1 μm pore size) using a Büchner setup connected to a vacuum pump (triplicate). Wash the filter with a solution of ammonium formate (0.5 M) to remove salts
- follow the same procedure with control filters on which an equal volume of 0.22- μm filtered seawater is filtered (triplicate). The strength of the applied vacuum will determine the amount of salts retained on the control filters.
- dry the filters at 100 °C for 4 h to volatilize the ammonium formate
- weigh on an analytical balance
- calculate the dry weight per algal cell according to the formula:

$$\text{DW (g.cell}^{-1}\text{)} = (\text{DW}_A - \text{DW}_C) \cdot (\text{N} \cdot \text{V})^{-1}$$

with DW_A = average dry weight retained on algal filter (g)
 DW_C = average dry weight retained on control filter (g)
 N = algal concentration (cells.ml^{-1})
 V = volume of algal culture and filtered seawater filtered on algal and control filter, respectively (ml)

In order to improve the correction for salt residues and the variation among samples, cellular dry weight can be determined from regression analysis of DW retained on the filter versus number of algal cells filtered (Fig. 2.18).

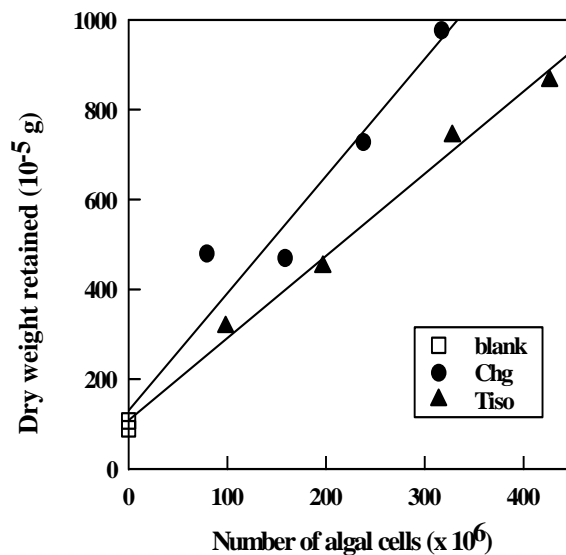

Figure 2.18. Dry weight analysis of algae by means of linear regression of dry weight retained on the filter *versus* number of algae cells filtered. Each data set represents the dry weight determination for algae obtained from one culture of, respectively *Isochrysis* sp. (T-iso) and *Chaetoceros neogracile* (Chg). Linear regression equations are : T-iso : $y = 1.83 x + 107.7$ ($r^2 = 0.99$) ; Chg : $y = 2.61 x + 130.1$ ($r^2 = 0.95$)

3. ROTIFERS

Philippe Dhert

Laboratory of Aquaculture & Artemia Reference Center
University of Gent, Belgium

3.1. Introduction

Although *Brachionus plicatilis* was first identified as a pest in the pond culture of eels in the fifties and sixties, Japanese researchers soon realized that this rotifer could be used as a suitable live food organism for the early larval stages of marine fish. The successful use of rotifers in the commercial hatchery operations of the red sea bream (*Pagrus major*) encouraged investigations in the development of mass culture techniques of rotifers. Twenty five years after the first use of rotifers in larviculture feeding several culture techniques for the intensive production of rotifers are being applied worldwide. The availability of large quantities of this live food source has contributed to the successful hatchery production of more than 60 marine finfish species and 18 species of crustaceans. To our knowledge, wild populations of rotifers are only harvested in one region in the P.R. China, (i.e. the Bohai Bay saltworks) where *Brachionus plicatilis* is used as food in local shrimp and crab hatcheries. The success of rotifers as a culture organism are manifold, including their planktonic nature, tolerance to a wide range of environmental conditions, high reproduction rate (0.7-1.4 offspring.female⁻¹.day⁻¹). Moreover, their small size and slow swimming velocity make them a suitable prey for fish larvae that have just resorbed their yolk sac but cannot yet ingest the larger *Artemia* nauplii. However, the greatest potential for rotifer culture resides, however, resides in the possibility of rearing these animals at very high densities (i.e. densities of 2000 animals.ml⁻¹ have been reported by Hirata (1979). Even at high densities, the animals reproduce rapidly and can thus contribute to the build up of large quantities of live food in a very short period of time. Last, but not least, the filter-feeding nature of the rotifers facilitates the inclusion into their body tissues of specific nutrients essential for the larval predators (i.e. through bioencapsulation; see further).

3.2. Morphology

Rotatoria (=Rotifera) belong to the smallest metazoa of which over 1000 species have been described, 90 % of which inhabit freshwater habitats. They seldom reach 2 mm in body length. Males have reduced sizes and are less developed than females; some measuring only 60 µm. The body of all species consists of a constant number of cells, the different *Brachionus* species containing approximately 1000 cells which should not be considered as single identities but as a plasma area. The growth of the animal is assured by plasma increase and not by cell division.

The epidermis contains a densely packed layer of keratin-like proteins and is called the lorica. The shape of the lorica and the profile of the spines and ornaments allow the determination of the different species and morphotypes (see 3.4.). The rotifer's body is differentiated into three distinct parts consisting of the head, trunk and foot (Fig. 3.1.). The head carries the rotatory organ or corona which is easily recognized by its annular ciliation and which is at the origin of the name of the Rotatoria (bearing wheels). The retractable corona assures locomotion and a whirling water movement which facilitates the uptake of small food particles (mainly algae and detritus). The trunk contains the digestive tract, the excretory system and the genital organs. A characteristic organ for the rotifers is the mastax (i.e. a calcified apparatus in the mouth region), that is very effective in grinding ingested particles. The foot is a ring-type retractable structure without segmentation ending in one or four toes.

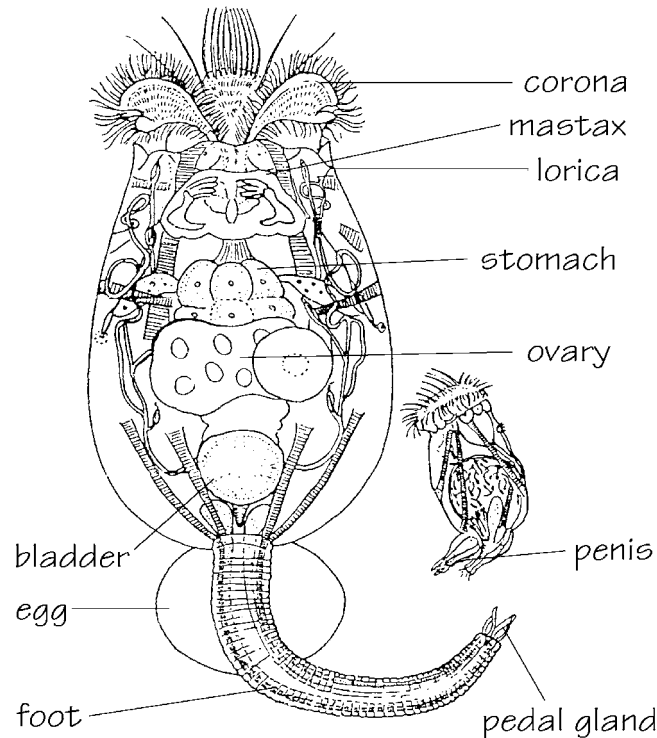

Figure 3.1. *Brachionus plicatilis*, female and male (modified from Koste, 1980).

3.3. Biology and life history

The life span of rotifers has been estimated to be between 3.4 to 4.4 days at 25° C. Generally, the larvae become adult after 0.5 to 1.5 days and females thereafter start to lay eggs approximately every four hours. It is believed that females can produce ten generations of offspring before they eventually die. The reproduction activity of *Brachionus* depends on the temperature of the environment as illustrated in Table 3.1.

The life cycle of *Brachionus plicatilis* can be closed by two modes of reproduction (Fig. 3.2.). During female parthenogenesis the amictic females produce amictic (diploid, 2n chromosomes) eggs which develop and hatch into amictic females. Under specific environmental conditions the females switch to a more complicated sexual reproduction resulting in mictic and amictic females. Although both are not distinguishable morphologically, the mictic females produce haploid (n chromosomes) eggs. Larvae hatching out of these unfertilized mictic eggs develop into haploid males. These males

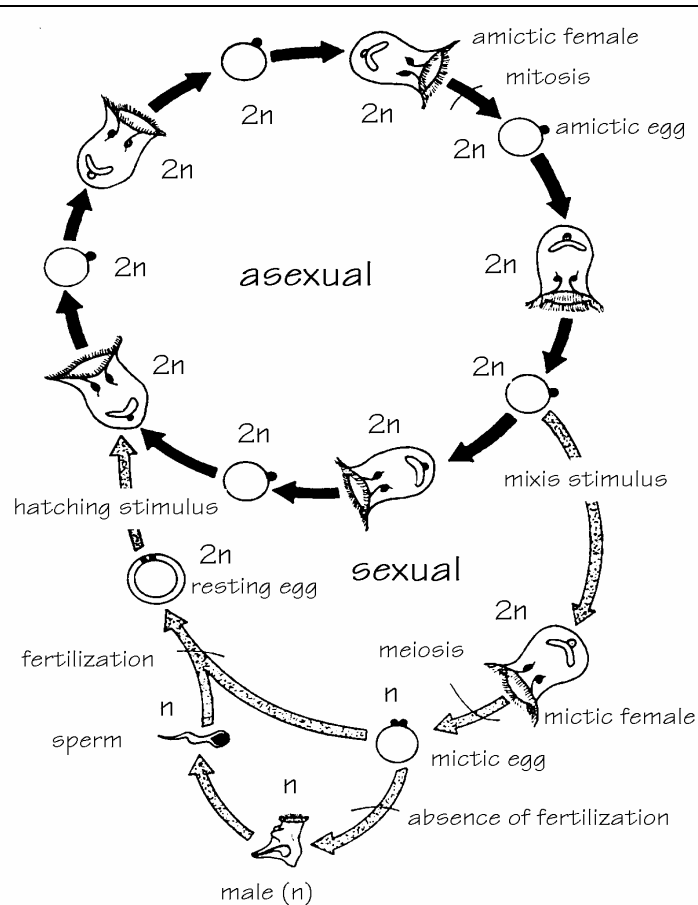

Figure 3.2. Parthenogenetical and sexual reproduction in *Brachionus plicatilis* (modified from Hoff and Snell, 1987).

are about one quarter of the size of the female; they have no digestive tract and no bladder but have an over-proportionated single testis which is filled with sperm. Mictic eggs which will hatch into males are significantly smaller in size, while the mictic fertilized eggs are larger and have a thick, faintly granulated outer layer.

These are the resting eggs that will only develop and hatch into amictic females after exposure to specific environmental conditions. These can be the result of changes in environmental conditions eventually creating alternations in temperature or salinity or changing food conditions. It should be emphasized that the rotifer density of the population also plays an important role in the determination of the mode of reproduction. Although the mechanism is not completely understood, it is generally believed that the production of resting eggs is a survival strategy of the population through unfavourable environmental conditions such as drought or cold.

3.4. Strain differences

Only a few rotifer species belonging to the genus *Brachionus* are used in aquaculture. As outlined in the introduction the most widely used species is *Brachionus plicatilis*, a cosmopolitan inhabitant of inland saline and coastal brackish waters. It has a lorica

length of 100 to 340 μm , with the lorica ending with 6 occipital spines (Fukusho, 1989).

However, for use in aquaculture, a simple classification is used which is based on two different morphotypes, namely *Brachionus rotundiformis* or small (S-type) rotifers and *Brachionus plicatilis* or large (L-type) rotifers. The differences among the two types can be clearly distinguished by their morphological characteristics: the lorica length of the L-type ranging from 130 to 340 μm (average 239 μm), and of the S-type ranging from 100 to 210 μm (average 160 μm). Moreover, the lorica of the S-type shows pointed spines, while of the L-type has obtuse angled spines (Fig. 3.3.).

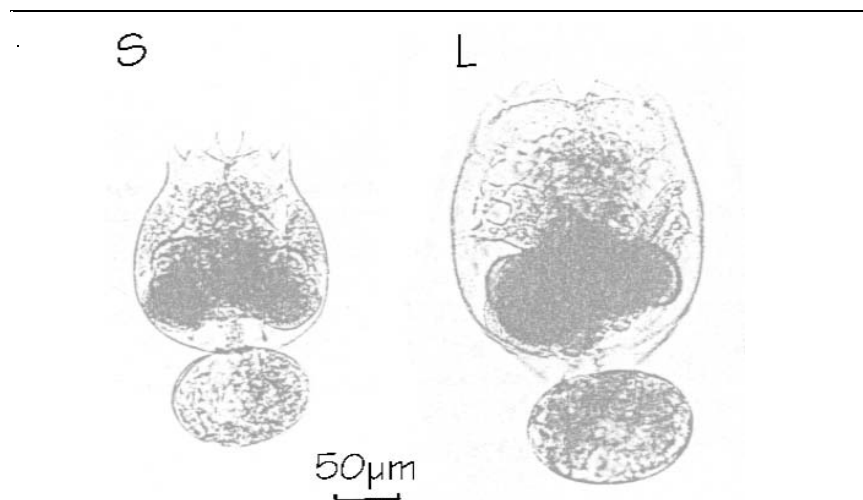

Figure 3.3. *Brachionus rotundiformis* (S-type) and *Brachionus plicatilis* (L-type) (modified from Fu et al., 1991).

In tropical aquaculture the SS-type rotifers (Super small rotifers) are preferred for the first feeding of fish larvae with small mouth openings (rabbitfish, groupers, and other fish with mouth openings at start feeding of less than 100 μm). Those rotifers, however, are genetically not isolated from S-strains, but are smaller than common S-strains.

The S- and L- morphotypes also differ in their optimal growth temperature. The S-type has an optimal growth at 28-35°C, while the L-type reaches its optimal growth at 18-25°C. Since contamination with both types of rotifers occurs frequently, lowering or increasing culture temperatures can be used to obtain pure cultures: rotifers at their upper or lower tolerance limit do not multiply as fast and can in this way be out-competed in favour of the desired morphotype.

It should be emphasized that, besides intraspecific size variations, important interspecific variation in size can occur as a function of salinity level or dietary regime. This polymorphism can result in a difference of maximal 15% (Fukusho and Iwamoto, 1981). Rotifers fed on baker's yeast are usually larger than those fed on live algae.

3.5. General culture conditions

3.5.1. Marine rotifers

3.5.1.1. Salinity

Although *Brachionus plicatilis* can withstand a wide salinity range from 1 to 97 ppt, optimal reproduction can only take place at salinities below 35 ppt (Lubzens, 1987). However, if rotifers have to be fed to predators which are reared at a different salinity (± 5 ppt), it is safe to acclimatize them as abrupt salinity shocks might inhibit the rotifers' swimming or even cause their death.

3.5.1.2. Temperature

The choice of the optimal culture temperature for rearing rotifers depends on the rotifer-morphotype; L-strain rotifers being reared at lower temperatures than S-type rotifers. In general, increasing the temperature within the optimal range usually results in an increased reproductive activity. However, rearing rotifers at high temperature enhances the cost for food. Apart from the increased cost for food, particular care has also to be paid to more frequent and smaller feeding distributions. This is essential for the maintenance of good water quality, and to avoid periods of overfeeding or starvation which are not tolerated at suboptimal temperature levels. For example, at high temperatures starving animals consume their lipid and carbohydrate reserves very fast.

Rearing rotifers below their optimal temperature slows down the population growth considerably. Table 3.1 shows the effect of temperature on the population dynamics of rotifers.

Table 3.1. Effect of temperature on the reproduction activity of *Brachionus plicatilis*. (After Ruttner-Kolisko, 1972).

Temperature (°C).	15 °C	20 °C	25 °C
Time for embryonic development (days).	1.3	1.0	0.6
Time for young female to spawn for the first time (days).	3.0	1.9	1.3
Interval between two spawnings (hours).	7.0	5.3	4.0
Length of life (days).	15	10	7
Number of eggs spawned by a female during her life.	23	23	20

3.5.1.3. Dissolved oxygen

Rotifers can survive in water containing as low as 2 mg.l⁻¹ of dissolved oxygen. The level of dissolved oxygen in the culture water depends on temperature, salinity, rotifer density, and the type of the food. The aeration should not be too strong as to avoid physical damage to the population.

3.5.1.4. pH

Rotifers live at pH-levels above 6.6, although in their natural environment under culture conditions the best results are obtained at a pH above 7.5.

3.5.1.5. Ammonia (NH₃)

The NH₃/NH₄⁺ ratio is influenced by the temperature and the pH of the water. High levels of un-ionized ammonia are toxic for rotifers but rearing conditions with NH₃-concentrations below 1 mg.l⁻¹ appear to be safe.

3.5.1.6. Bacteria

Pseudomonas and *Acinetobacter* are common opportunistic bacteria which may be important additional food sources for rotifers. Some *Pseudomonas* species, for instance, synthesize vitamin B₁₂ which can be a limiting factor under culture conditions (Yu *et al.*, 1988).

Although most bacteria are not pathogenic for rotifers their proliferation should be avoided since the real risk of accumulation and transfer via the food chain can cause detrimental effects on the predator.

A sampling campaign performed in various hatcheries showed that the dominant bacterial flora in rotifer cultures was of *Vibrio* (Verdonck *et al.*, 1994). The same study showed that the microflora of the live food was considerably different among hatcheries; especially after enrichment, high numbers of associated bacteria were found. The enrichment of the cultures generally induces a shift in the bacterial composition from *Cytophaga/Flavobacterium* dominance to *Pseudomonas/Alcaligenes* dominance. This change is partly due to a bloom of fast growing opportunistic bacteria, favoured by high substrate levels (Skjermo and Vadstein, 1993).

The bacterial numbers after enrichment can be decreased to their initial levels by appropriate storage (6°C) and adjustment of the rotifer density (Skjermo and Vadstein, 1993). A more effective way to decrease the bacterial counts, especially the counts of the dominant *Vibrionaceae* in rotifers, consists of feeding the rotifers with *Lactobacillus plantarum* (Gatesoupe, 1991). The supplementation of these probiotic bacteria not only has a regulating effect on the microflora but also increases the production rate of the rotifers.

For stable rotifer cultures, the microflora as well as the physiological condition of the rotifers, has to be considered. For example, it has been demonstrated that the dietary condition of the rotifer *Brachionus plicatilis* can be measured by its physiological performance and reaction to a selected pathogenic bacterial strain (*Vibrio anguillarum* TR27); the *V. anguillarum* strain administered at 10⁶-10⁷ colony forming units (CFU).ml⁻¹ causing a negative effect on rotifers cultured on a sub-optimal diet while the rotifers grown on an optimal diet were not affected by the bacterial strain. Comparable results were also reported by Yu *et al.* (1990) with a *Vibrio alginolyticus* strain Y5 supplied at a concentration of 2.5.10⁴CFU.ml⁻¹.

3.5.1.7. Ciliates

Halotricha and Hypotricha ciliates, such as *Uronema* sp. and *Euplotes* sp., are not desired in intensive cultures since they compete for feed with the rotifers. The appearance of these ciliates is generally due to sub-optimal rearing conditions, leading to less performing rotifers and increased chances for competition. Ciliates produce metabolic wastes which increase the NO_2^- -N level in the water and cause a decrease in pH. However, they have a positive effect in clearing the culture tank from bacteria and detritus. The addition of a low formalin concentration of 20 mg.l^{-1} to the algal culture tank, 24 h before rotifer inoculation can significantly reduce protozoan contamination. Screening and cleaning of the rotifers through the use of phytoplankton filters ($< 50 \mu\text{m}$) so as to reduce the number of ciliates or other small contaminants is an easy precaution which can be taken when setting up starter cultures.

3.5.2. Freshwater rotifers

Brachionus calyciflorus and *Brachionus rubens* are the most commonly cultured rotifers in freshwater mass cultures. They tolerate temperatures between 15 to 31°C . In their natural environment they thrive in waters of various ionic composition. *Brachionus calyciflorus* can be cultured in a synthetic medium consisting of 96 mg NaHCO_3 , 60 mg $\text{CaSO}_4 \cdot 2\text{H}_2\text{O}$, 60 mg MgSO_4 and 4 mg KCl in 1 l of deionized water. The optimal pH is 6-8 at 25°C , minimum oxygen levels are 1.2 mg.l^{-1} . Free ammonia levels of 3 to 5 mg.l^{-1} inhibit reproduction.

Brachionus calyciflorus and *Brachionus rubens* have been successfully reared on the microalgae *Scenedesmus costato-granulatus*, *Kirchneriella contorta*, *Phacus pyrum*, *Ankistrodesmus convolvulus* and *Chlorella*, as well as yeast and the artificial diets Culture Selco[®] (Inve Aquaculture, Belgium) and Roti-Rich (Florida Aqua Farms Inc., USA). The feeding scheme for *Brachionus rubens* needs to be adjusted as its feeding rate is somewhat higher than that of *B. plicatilis*.

3.5.3. Culture procedures

Intensive production of rotifers is usually performed in batch culture within indoor facilities; the latter being more reliable than outdoor extensive production in countries where climatological constraints do not allow the outdoor production of microalgae. Basically, the production strategy is the same for indoor or outdoor facilities, but higher starting and harvesting densities enable the use of smaller production tanks (generally 1 to 2 m^3) within intensive indoor facilities. In some cases, the algal food can be completely substituted by formulated diets (see 3.5.3.6.).

3.5.3.1. Stock culture of rotifers

Culturing large volumes of rotifers on algae, baker's yeast or artificial diets always involves some risks for sudden mortality of the population. Technical or human failures but also contamination with pathogens or competitive filter feeders are the main causes for lower reproduction which can eventually result in a complete crash of the population. Relying only on mass cultures of rotifers for reinoculating new tanks is too risky an approach. In order to minimize this risk, small stock cultures are generally kept in closed vials in an isolated room to prevent contamination with bacteria and/or ciliates.

These stock cultures which need to generate large populations of rotifers as fast as possible are generally maintained on algae.

The rotifers for stock cultures can be obtained from the wild, or from research institutes or commercial hatcheries. However, before being used in the production cycle the inoculum should first be disinfected. The most drastic disinfection consists of killing the free-swimming rotifers but not the eggs with a cocktail of antibiotics (e.g. erythromycin 10 mg.l⁻¹, chloramphenicol 10 mg.l⁻¹, sodium oxolinat 10 mg.l⁻¹, penicillin 100 mg.l⁻¹, streptomycin 20 mg.l⁻¹) or a disinfectant. The eggs are then separated from the dead bodies on a 50 µm sieve and incubated for hatching and the offspring used for starting the stock cultures. However, if the rotifers do not contain many eggs (as can be the case after a long shipment) the risk of losing the complete initial stock is too big and in these instances the rotifer should be disinfected at sublethal doses; the water of the rotifers being completely renewed and the rotifers treated with either antibiotics or disinfectants. The treatment is repeated after 24 h in order to be sure that any pathogens which might have survived the passage of the intestinal tract of the rotifers are killed as well. The concentration of the disinfection products differs according to their toxicity and the initial condition of the rotifers. Orientating concentrations for this type of disinfection are 7.5 mg.l⁻¹ furazolidone, 10 mg.l⁻¹ oxytetracycline, 30 mg.l⁻¹ sarafloxacin, or 30 mg.l⁻¹ linco-spectin.



Figure 3.4. Stock cultures of rotifers kept in 50 ml centrifuge tubes. The tubes are fixed on a rotor. At each rotation the medium is mixed with the enclosed air.

At the Laboratory of Aquaculture & Artemia Reference Center the stock cultures for rotifers are kept in a thermo-climatised room (28°C ± 1°C). The vials (50 ml conical centrifuge tubes) are previously autoclaved and disposed on a rotating shaft (4 rpm). At each rotation the water is mixed with the enclosed air (± 8 ml), providing enough oxygen for the rotifers (Fig. 3.4.). The vials on the rotor are exposed to the light of two fluorescent light tubes at a distance of 20 cm (light intensity of 3000 lux on the tubes).

with 5 mg.l⁻¹ NaOCl. The next day the excess of NaOCl is neutralized with Na₂S₂O₃ (for neutralization and color reaction see worksheet 3.1.) and the water is filtered over a 0.45 µm filter.

The culture water (seawater diluted with tap water to a salinity of 25 ppt) is aerated, prefiltered over a 1 µm filter bag and disinfected overnight

Inoculation of the tubes is carried out with an initial density of 2 rotifers.ml⁻¹. The food consists of marine *Chlorella* cultured according to the procedure described in 2.3. The algae are centrifuged and concentrated to 1-2.10⁸ cells.ml⁻¹. The algal concentrate is stored at 4°C in a refrigerator for a maximum period of 7 days, coinciding with one rotifer rearing cycle. Every day the algal concentrate is homogenized by shaking and

200 μl is given to each of the tubes. If fresh algae are given instead of the algal concentrate 4 ml of a good culture is added daily.

After one week the rotifer density should have increased from 2 to 200 individuals. ml^{-1} (Fig. 3.5.). The rotifers are rinsed, a small part is used for maintenance of the stock, and the remaining rotifers can be used for upscaling. Furthermore, after some months of regular culture the stock cultures will be disinfected as described earlier in order to keep healthy and clean stock material. However, the continuous maintenance of live stock cultures of *Brachionus* does not eliminate the risk of bacterial contamination.

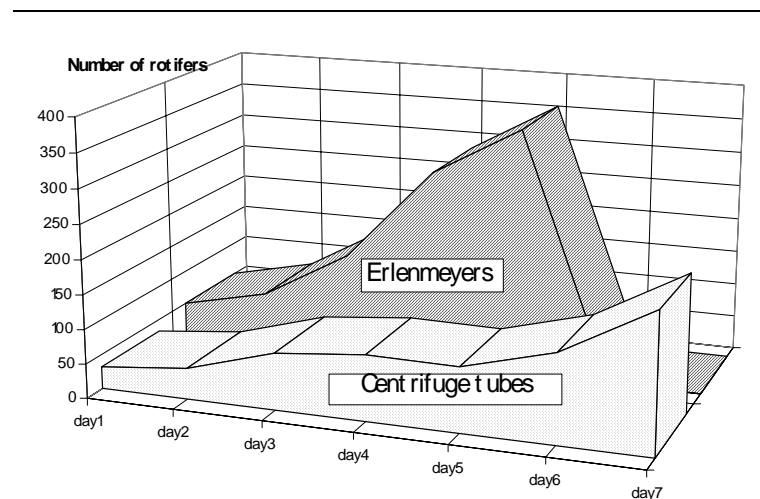

Figure 3.5. Growth rate of the rotifer population in the stock cultures (centrifuge tubes) and during the upscaling in erlenmeyers.

Treatment with anti-biotics might lower the bacterial load, but also implies the risk for selection of antibiotic-resistant bacteria. However, the commercial availability of resting eggs could be an alternative to maintaining stock cultures and reducing the chances for contamination with ciliates or pathogenetic bacteria (see Fig. 3.7.).

3.5.3.2. Upscaling of stock cultures to starter cultures

The upscaling of rotifers is carried out in static systems consisting of erlenmeyers of 500 ml placed 2 cm from fluorescent light tubes (5000 lux). The temperature in the erlenmeyers should not be more than 30°C. The rotifers are stocked at a density of 50 individuals. ml^{-1} and fed 400 ml freshly-harvested algae (*Chlorella* 1.6.10⁶ cells. ml^{-1}); approximately 50 ml of algae being added every day to supply enough food. Within 3 days the rotifer concentration can increase to 200 rotifers. ml^{-1} (Fig. 3.5.). During this short rearing period no aeration is applied.

Once the rotifers have reached a density of 200-300 individuals. ml^{-1} they are rinsed on a submerged filter consisting of 2 filter screens. The upper mesh size (200 μm) retains large waste particles, while the lower sieve (50 μm) collects the rotifers. If only single strainers are available this handling can be carried out with two separate filters.

Moreover, if rinsing is performed under water the rotifers will not clog and losses will be limited to less than 1%.

The concentrated rotifers are then distributed in several 15 l bottles filled with 2 l water at a density of 50 individuals.ml⁻¹ and a mild tube aeration provided. In order to avoid contamination with ciliates the air should be filtered by a cartridge or activated carbon filters. Fresh algae (*Chlorella* 1.6 x 10⁶ cells.ml⁻¹) are supplied daily. Every other day the cultures are cleaned (double-screen filtration) and restocked at densities of 200 rotifers.ml⁻¹. After adding algae for approximately one week the 15 l bottles are completely full and the cultures can be used for inoculation of mass cultures.

3.5.3.3. Mass production on algae

Undoubtedly, marine microalgae are the best diet for rotifers and very high yields can be obtained if sufficient algae are available and an appropriate management is followed. Unfortunately in most places it is not possible to cope with the fast filtration capacity of the rotifers which require continuous algal blooms. If the infrastructure and labor is not limiting, a procedure of continuous (daily) harvest and transfer to algal tanks can be considered. In most places, however, pure algae are only given for starting up rotifer cultures or to enrich rotifers (see 3.5.3.1. and 3.6.1.1.).

Batch cultivation is probably the most common method of rotifer production in marine fish hatcheries. The culture strategy consists of either the maintenance of a constant culture volume with an increasing rotifer density or the maintenance of a constant rotifer density by increasing the culture volume (see 3.5.3.4.). Extensive culture techniques (using large tanks of more than 50 m³) as well as intensive methods (using tanks with a volume of 200-2000 l) are applied. In both cases large amounts of cultured microalgae, usually the marine alga *Nannochloropsis*, are usually inoculated in the tanks together with a starter population containing 50 to 150 rotifers.ml⁻¹.

3.5.3.4. Mass production on algae and yeast

Depending on the strategy and the quality of the algal blooms baker's yeast may be supplemented. The amount of yeast fed on a daily basis is about 1 g.million⁻¹ of rotifers, although this figure varies depending on the rotifer type (S,L) and culture conditions. Since algae have a high nutritional value, an excellent buoyancy and do not pollute the water, they are used as much as possible, not only as a rotifer food, but also as water conditioners and bacteriostatic agents.

In contrast to most European rearing systems, Japanese developed large culture systems of 10 to 200 metric tons. The initial stocking density is relatively high (80-200 rotifers.ml⁻¹) and large amounts of rotifers (2-6 x 10⁹) are produced daily with algae (4-40 m³) supplemented with yeast (1-6 kg).

The mass production on algae and yeast is performed in a batch or semi-continuous culture system. Several alterations to both systems have been developed, and as an example the rearing models used at The Oceanic Institute in Hawaii are described here:

- Batch culture system

The tanks (1 200 l capacity) are half filled with algae at a density of $13\text{-}14 \times 10^6$ cells.ml⁻¹ and inoculated with rotifers at a density of 100 individuals.ml⁻¹. The salinity of the water is 23 ppt and the temperature maintained at 30°C. The first day active baker's yeast is administered two times a day at a quantity of 0.25 g/10⁶ rotifers. The next day the tanks are completely filled with algae at the same algal density and 0.375 g baker's yeast per million rotifers is added twice a day. The next day the rotifers are harvested and new tanks are inoculated (i.e. two-day batch culture system).

- Semi-continuous culture

In this culture technique the rotifers are kept in the same tank for five days. During the first two days the culture volume is doubled each day to dilute the rotifer density in half. During the next following days, half the tank volume is harvested and refilled again to decrease the density by half. On the fifth day the tank is harvested and the procedure started all over again (i.e. five-day semi-continuous culture system).

The nutritional composition of algae-fed rotifers does not automatically meet the requirements of many predator fish and sometimes implies an extra enrichment step to boost the rotifers with additional nutritional components such as fatty acids, vitamins or proteins (see 3.6.). Also, the addition of vitamins, and in particular vitamin B₁₂, has been reported as being essential for the culture of rotifers (Yu *et al.*, 1989).

3.5.3.5. Mass culture on yeast

Baker's yeast has a small particle size (5-7 µm) and a high protein content and is an acceptable diet for *Brachionus*. The first trials to replace the complete natural rotifer diet by baker's yeast were characterized by varying success and the occurrence of sudden collapses of the cultures (Hirayama, 1987). Most probably the reason for these crashes was explained by the poor digestibility of the yeast, which requires the presence of bacteria for digestion. Moreover, the yeast usually needs to be supplemented with essential fatty acids and vitamins to suit the larval requirements of the predator organisms. Commercial boosters, but also home-made emulsions (fish oils emulgated with commercial emulgators or with egg-yolk lecithin), may be added to the yeast or administered directly to the rotifer tank (see 3.6.1.3.). Better success was obtained with so called ω-yeast-fed rotifers (rotifers fed on a yeast preparation produced by adding cuttlefish liver oil at a 15% level to the culture medium of baker's yeast) which ensured a high level of (n-3) essential fatty acids in the rotifers (Watanabe *et al.*, 1983). The necessity of adding the component in the food of the rotifer or to the rotifers' culture medium was later confirmed by using microparticulate and emulsified formulations (Watanabe *et al.*, 1983; Léger *et al.*, 1989). Apart from fresh baker's yeast, instant baker's yeast, marine yeast (*Candida*) or caked yeast (*Rhodotorula*) may also be used.

3.5.3.6. Mass culture on formulated diets

The most frequently used formulated diet in rotifer culture in Europe is Culture Selco® (CS) available under a dry form. It has been formulated as a complete substitute for live microalgae and at the same time guarantees the incorporation of high levels of EFA and vitamins in the rotifers. The biochemical composition of the artificial diet Culture Selco® consists of 45% proteins, 30% carbohydrates, 15% lipids (33% of which are (n-3) HUFA), and 7% ash. Its physical characteristics are optimal for uptake by rotifers: the particle, having a 7 µm particle size, remaining in suspension in the water column with a relatively strong

aeration, and not leaching. However, the diet needs to be suspended in water prior to feeding, which facilitates on one hand the possibilities for automatic feeding but on the other hand requires the use of aeration and cold storage. The following standard culture procedure has been developed and tested on several rotifer strains in 100 l tanks.

Cylindro-conical tanks of 100 l with dark smooth walls (polyethylene) are set up in shaded conditions. The culture medium consists of diluted seawater of 25 ppt kept at 25°C. No water renewal takes place during the 4-day culture period. Air stones are installed a few cm above the cone bottom of the tank to allow sedimentation and possible flushing of waste particles. Food flocculates are trapped in pieces of cloth which are suspended in the water column (Fig. 3.6a.), or in an air-water-lift trap filled with sponges (Fig. 3.6b.).

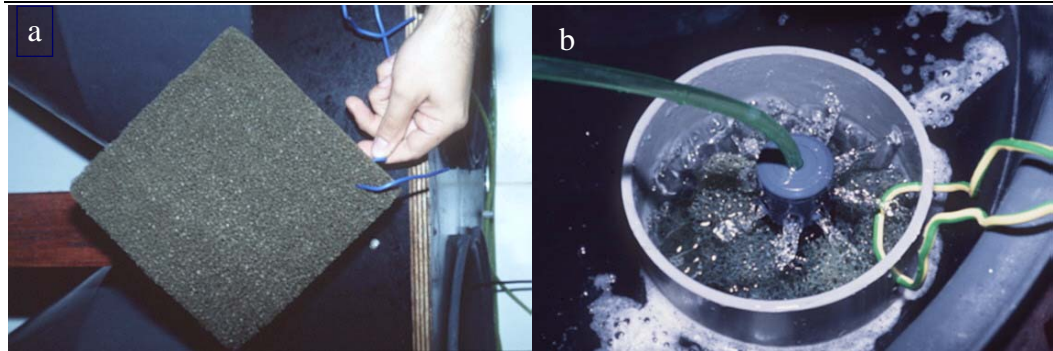

Figure 3.6. Piece of cloth (a) and air-water-lift filled with sponges (b) to trap the floccules in the rotifer tank.

Table 3.2. Feeding regime for optimal rotifer culture in function of the rotifer density using the formulated diet Culture Selco®.

Rotifer density.ml ⁻¹ (L-strain)	Culture Selco® per 10 ⁶ rotifers.day ⁻¹ (in g)	Culture Selco® per m ³ .day ⁻¹ (in g)
100 - 150	0.53	53 - 80
150 - 200	0.47	70 - 93
200 - 250	0.40	80 - 100
250 - 300	0.37	92 - 110
300 - 350	0.33	100 - 117
350 - 400	0.30	105 - 120

Table 3.2. (contd.) Feeding regime for optimal rotifer culture in function of the rotifer density using the formulated diet Culture Selco®.

400 - 450	0.27	107 - 120
450 - 500	0.23	105 - 117
> 500	0.25	125
> 1200	0.20	240

Furthermore, all efforts are made to maintain a good water quality with minimal accumulations of wasted food by assuring short retention times of the food particles. This is achieved by using high starting densities of 200 rotifer/ml⁻¹ and the distribution of small amounts of feed at hourly intervals; the latter can easily be automated by pumping the feed suspension from a gently aerated stock kept in a refrigerator at 4°C for up to 30 h (Fig. 3.7.). Applying this feeding strategy, an optimized feeding regime is developed in function of the rotifer density and the culture performance (Table 3.2.). It should be indicated that this protocol is developed for the L-rotifer strain and should be slightly adapted (less feed) when a S-rotifer strain is used.

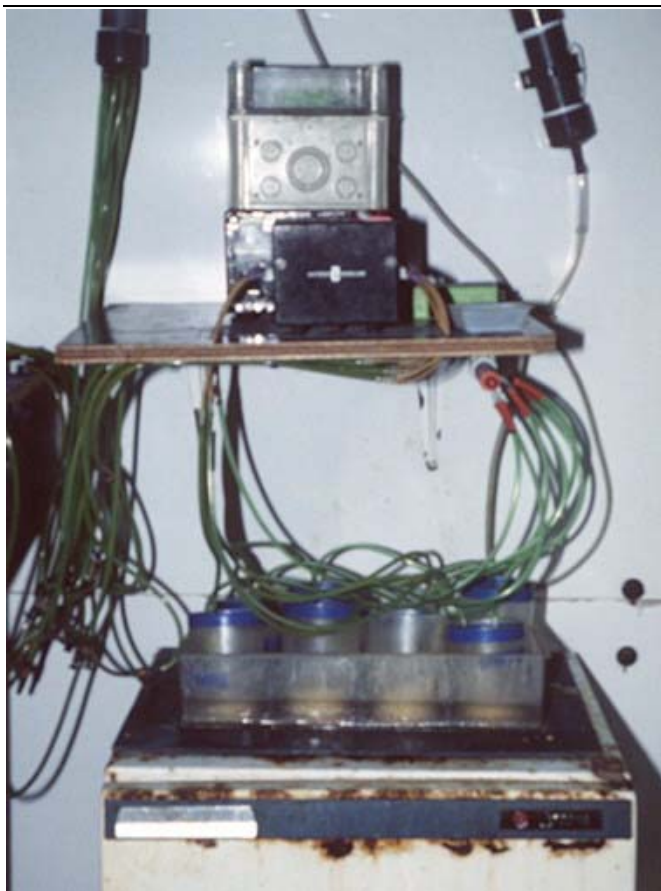

Figure 3.7. Refrigerated feed suspension distributed to the individual rotifer tanks by means of a peristaltic pump.

Applying this standard culture strategy a doubling of the population is achieved every two days, reaching a harvest density of 600 rotifers.ml⁻¹ after four days only (Table 3.3.), which is better than for the traditional technique using live algae (and baker's yeast). There is no high variation in production characteristics among the various culture tests and crashes are rarely observed, which most probably is due to the non-introduction of microbial contaminants and the overall good water quality over the culture period. In this respect, it should be emphasized that hygienic precautions should be taken to avoid contacts among different rearing units. All material used during the production (i.e. glass ware) can be disinfected in water baths with NaOCl, HCl or other disinfectants. After each production cycle (4 days) the tanks, airstones and tubing need to be disinfected thoroughly. In order to avoid crashes it is recommended that after approximately one month of culture that the complete system be disinfected and the cultures started again using rotifers from starter cultures.

In commercial hatcheries, peristaltic pumps are not always available. In this case the artificial diet can be fed on a daily basis at a concentration of 400-600 mg/10⁻⁶ rotifers, and administered in 4 to 6 rations with a minimum quantity of 50 - 100 mg.l⁻¹ culture medium. Analogous production outputs are achieved under upscaling conditions in commercial hatcheries (Table 3.3.).

Table 3.3. Growth and reproduction characteristics of rotifers reared on CS under experimental and upscaled conditions.

Experimental	Batch 1	Batch 2	Batch 3
Age of the population	Number of rotifers per ml		
Day 1	200	200	200
Day 2	261 ± 13	327 ± 17	280 ± 12
Day 3	444 ± 65	473 ± 42	497 ± 25
Day 4	581 ± 59	687 ± 44	681 ± 37
Growth rate.day ⁻¹	0.267	0.308	0.306
Doubling time	2.60	2.25	2.27
Commercial	Batch 1		
Age of the population	Number of rotifers per ml		
Day 1	200		
Day 2	285		
Day 3	505		
Day 4	571		
Day 5	620		

In order to avoid several manual feedings per day, a simple drip-feeding technique can be used as illustrated in Fig. 3.8. A concentrated food suspension is placed in the tank and water is dripped in the food suspension that is gradually diluted and allowed to over-flow into the rotifer tank. Since the overhead tank only contains water the flow rate can be adjusted without danger of clogging. The dimensions of the tank should be made as such that the complete content of the food tank is diluted in 24 h.

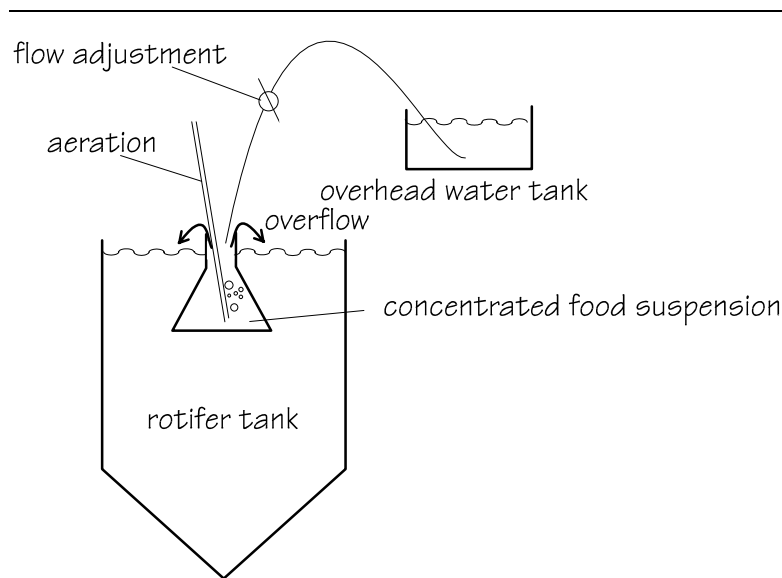

Figure 3.8. Illustration of the drip-feeding technique which can be applied when no sophisticated pumping devices are available.

3.5.3.7. High density rearing

Although high density rearing of rotifers increases the risk for more stressful rearing conditions, and an increased risk of reduced growth rates due to the start of sexual reproduction, promising results have been obtained in controlled cultures. The technique is the same as the one used for the mass culture on Culture Selco® but after each cycle of 4 days the rotifer density is not readjusted. The feeding scheme is adjusted to 0.25-0.3 g/10⁶ of rotifers for densities between 500 and 1500 rotifers.ml⁻¹ and to 0.2 g for densities above 1500 rotifers.ml⁻¹. Rearing rotifers at high stocking densities has a direct repercussion on the egg ratio (Fig. 3.9.). This latter is dropping from an average of 30 % at a density of 150 rotifers.ml⁻¹ to 10 % at a density of 2000 rotifers.ml⁻¹ and less than 5% at densities of 5000 rotifers.ml⁻¹. Maintaining cultures with this low egg ratio is more risky and thus the system should only be used under well controlled conditions.

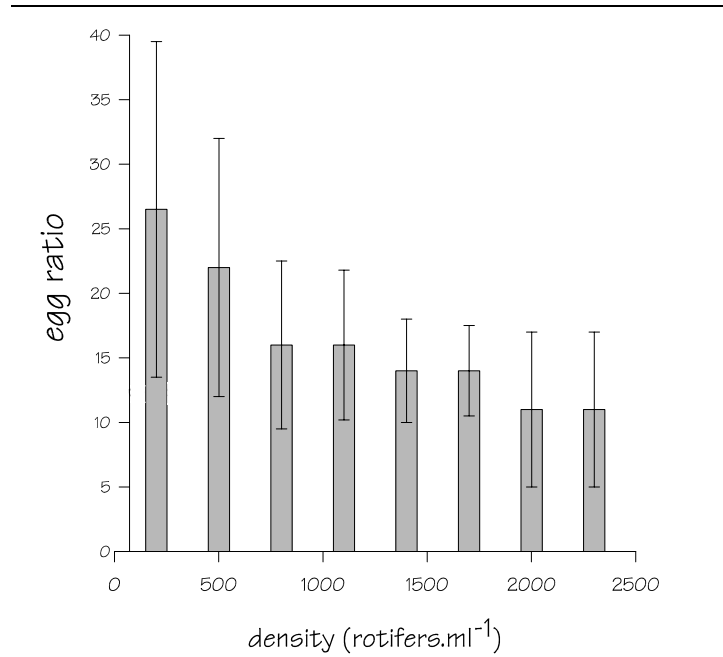

Figure 3.9. Effect of high density rotifer culture on the egg ratio.

High density cultivation of *Brachionus* is also being performed in Japan. In this technique *Nannochloropsis* is being supplemented with concentrated fresh water *Chlorella*, baker's yeast and yeast containing fish oil. Freshwater *Chlorella* is being used for vitamin B₁₂ supplementation ($\pm 12 \text{ mg.l}^{-1}$ at a cell concentration of $1.5 \cdot 10^{10} \text{ cells.ml}^{-1}$). In continuous cultures the rotifer population doubles every day. Half the culture is removed daily and replaced by new water. Using this system average densities of $1000 \text{ rotifers.ml}^{-1}$ are achieved with peaks of more than $3000 \text{ animals.ml}^{-1}$.

3.5.4. Harvesting/concentration of rotifers

Small-scale harvesting of rotifers is usually performed by siphoning the content of the culture tank into filter bags with a mesh size of $50\text{-}70 \mu\text{m}$. If this is not performed in submerged filters the rotifers may be damaged and result in mortality. It is therefore recommended to harvest the rotifers under water; concentrator rinsers are very convenient for this purpose (Fig. 3.10.). Aeration during the concentration of rotifers will not harm the animals, but should not be too strong so as to avoid clogging of the rotifers, this can be very critical, specially after enrichment (see Fig. 3.6.4.).



Figure 3.10. Side and upper view of a concentrator rinser containing a filter with a mesh size of 50 μm and equipped with an aeration collar at the bottom.

3.6. Nutritional value of cultured rotifers

3.6.1. Techniques for (n-3) HUFA enrichment

3.6.1.1. Algae

The high content of the essential fatty acid eicosapentaenoic acid (EPA 20:5n-3) and docosahexaenoic acid (DHA 22:6n-3) in some microalgae (e.g. 20:5n-3 in *Nannochloropsis occulata* and 22:6n-3 in *Isochrysis galbana*) have made them excellent live food diets for boosting the fatty acid content of the rotifers. Rotifers submerged in these algae (approximately $5 \cdot 10^6$ algae. ml^{-1}) are incorporating the essential fatty acids in a few hours time and come to an equilibrium with a DHA/EPA level above 2 for rotifers submerged in *Isochrysis* and below 0.5 for *Tetraselmis* (Fig. 3.11.). However, the culture of microalgae as a sole diet for rotifer feeding is costly due to the labour intensive character of microalgae production. Most of the time the rotifers are boosted in oil emulsions (see 3.6.1.3.) and fed to the predators which are kept in “green water”. This “green water”, consisting of $\pm 0.2 \cdot 10^6$ algal cells. ml^{-1} (*Tetraselmis*, *Nannochloropsis*, or *Isochrysis*) is applied to maintain an appropriate HUFA (but also other components) content in the live prey before they are eventually ingested by the predator (see also 2.5.3.).

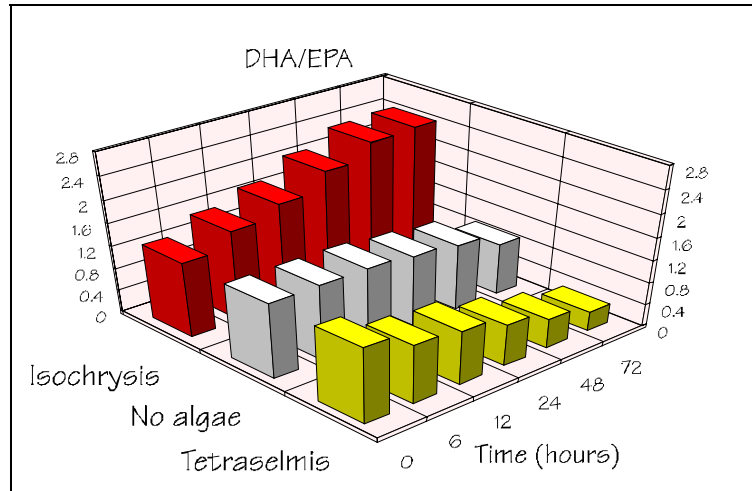

Figure 3.11. Changes in DHA/EPA ratio of rotifers in different algal media.

3.6.1.2. Formulated feeds

Rotifers grown on the CS[®] replacement diet have already an excellent HUFA composition: 5.4, 4.4 and 15.6 mg.g⁻¹ dry matter of EPA, DHA and (n-3) HUFA respectively (Fig. 3.12.), which is significantly higher than for cultures grown on algae/baker's yeast but comparable in case the latter cultures are subjected to an additional enrichment treatment (Léger *et al.*, 1989). The level of total lipids is approximately 18%. Since the use of CS[®] allows direct enrichment of the rotifers without the need of a cumbersome bioencapsulation treatment, complementary diets such as Protein Selco[®] (PS) and DHA Culture Selco[®] (DHA-CS) have been developed in order to incorporate higher levels of protein and DHA (Table 3.4.). The advantage of direct (or long term) enrichment are multiple; in that. the fatty acid profile obtained is stable and reproducible, the lipid content is comparable to that obtained in wild zooplankton, rotifer losses are lower and labour costs can be reduced.

Table 3.4. Characteristics of some diets and emulsions containing high DHA levels (in mg.g⁻¹ DW).

Diets	EPA	DHA	DHA/EPA	Σ(n-3)HUFA > 20:3n-3
CS	18.9	15.3	0.8	36.4
DHA-CS	16.9	26.7	1.6	45.4
DHA-PS	24.4	70.6	2.9	99.3
Emulsions				
DHA7	67.2	452.3	6.7	550.6
DHA20	0.8	15.6	19.5	16.4

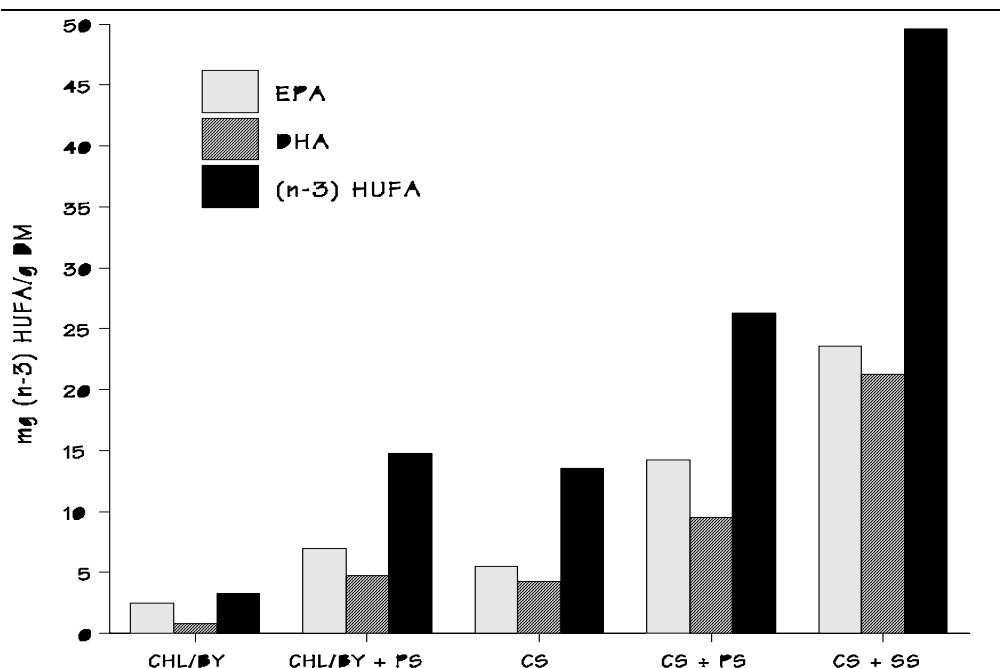

Figure 3.12. HUFA levels for various rotifer productions (CHL: *Chlorella* sp.; BY: Baker's yeast; PS: Protein Selco® CS: Culture Selco®; SS: Super Selco®).

However, for some marine larval fishes that require still higher (n-3) HUFA levels an additional enrichment with boosters may be necessary (Table 3.4.).

3.6.1.3. Oil emulsions

One of the cheapest ways to enrich rotifers is by using oil emulsions. Although home-made emulsions can be prepared with egg lecithin and fish oils (Watanabe *et al.*, 1982). Commercial emulsions are generally more stable and have a selected HUFA composition.

- Home-made emulsions

The first emulsions were made from (n-3) HUFA rich fish oils (i.e. cuttlefish oil, pollack liver oil, cod liver oil, menhaden oil, etc.) and emulsified with egg yolk and seawater (Watanabe *et al.*, 1982, 1983). Recently, more purified oils containing specifically high levels of the essential fatty acids 20:5n-3 and 22:6n-3 have been used. Since the stability and storage possibility of these products is relatively low they are usually made on the spot and used immediately.

For very specific applications, or when the requirements of the fish can not be fulfilled with commercial emulsions, this technique may also be used to incorporate lipid extracts from zooplankton, fish, fish roe, or other sources. A comparison of two commercially formulated (Super Selco® and DHA-Super

Selco®) and two self home-made emulsified enrichment diets are given in Figs. 3.13. and 3.14.

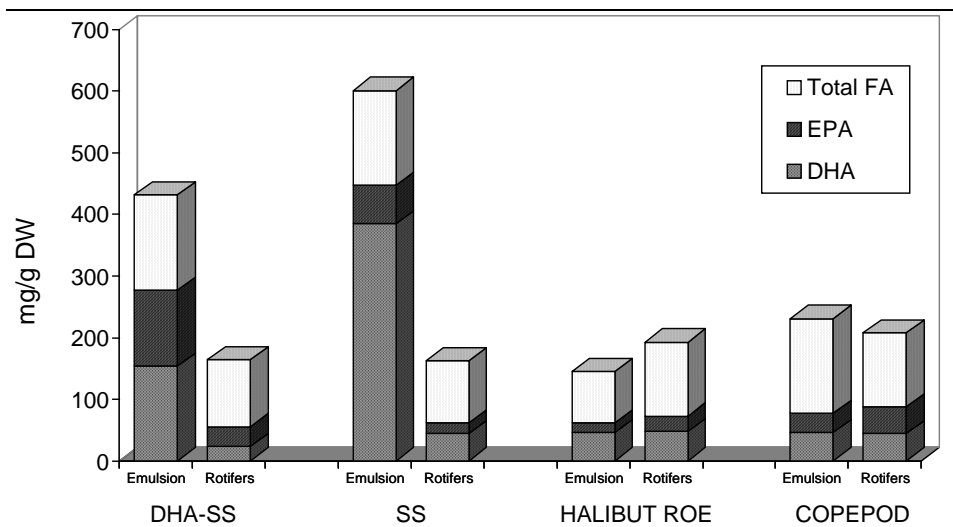

Figure 3.13. EPA, DHA and total fatty acid content in two commercial emulsions (DHA Super Selco®, DHA-SS and Super Selco®, SS) and in the enriched rotifers; emulsions made up with halibut roe and copepod extracts, and in the enriched rotifers (modified from Reitan *et al.* 1994)

- Commercial emulsions

Several emulsified diets are commercially available and based on well-defined formulations. Very popular are the self-emulsifying concentrates (Selco®, Inve Aquaculture NV, Belgium) which can boost the HUFA content of the rotifers in a few hours. In this technique a rotifer suspension containing 200-300 individuals.ml⁻¹ is immersed in a diluted oil-emulsion for 6 h, harvested, rinsed and concentrated before being fed to the predators.

In view of the importance of DHA in marine larviculture, considerable efforts have recently been made to incorporate high levels of DHA and/or high ratios of DHA/EPA in rotifers. To date the best results have been obtained using the self-emulsifying product DHA-Super Selco®. Compared to the results obtained with Super Selco®, the boosting of CS-rotifers with this product under standard enrichment practices results in a threefold increase of DHA and total (n-3) HUFA.

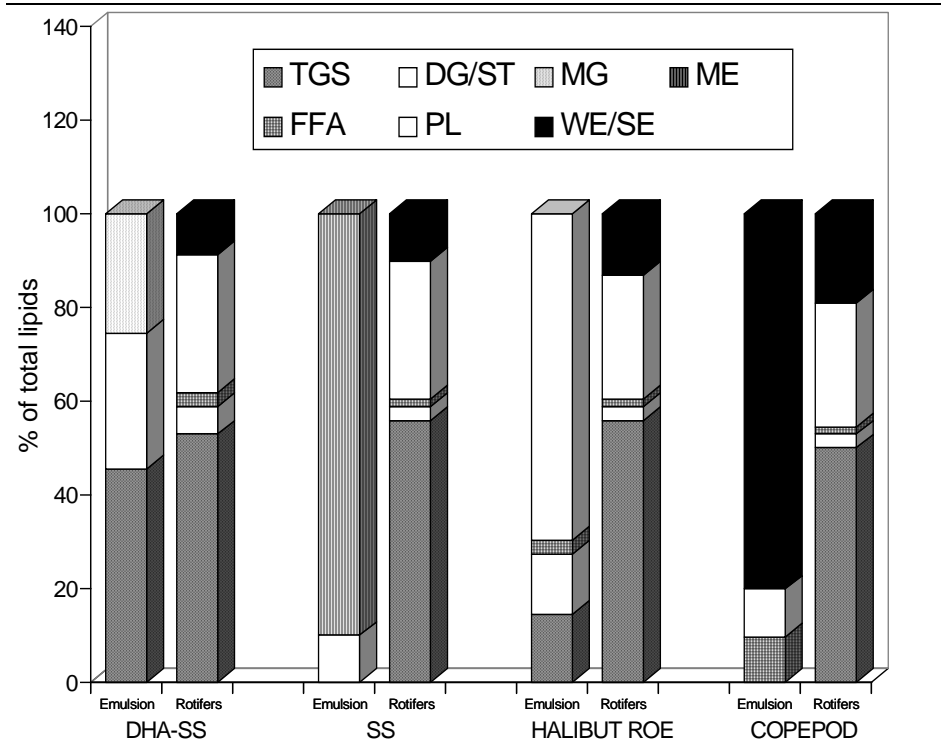

Figure 3.14. Lipid class composition in the emulsions (DHA Super Selco[®], Super Selco[®], halibut roe and copepods) and in the enriched rotifers. TGS : triglycerides, DG: diacylglycerides, ST: sterols, MG: monoacylglycerides, ME: methyl esters, FFA: free fatty acids, PL: phospholipids, WE : wax esters, SE: sterol esters.

Furthermore, the evolution of the concentrations of EFA within enriched rotifers after being administered to the predator tanks has been investigated. Results reveal that EFA levels remain rather constant for at least 7 h under clear water culture conditions at 20°C; with only a 30% drop in DHA being noted after 12 h (Table 3.5.).

Most commercial emulsions are rich in triacylglycerols and/or methyl esters and no emulsions have been formulated with phospholipids and/or wax esters. In Fig. 3.13. the most commonly used commercial emulsions are compared with home-made emulsions obtained from halibut roe and copepod extracts. Although the content of DHA and EPA is much lower in the latter emulsions, their relative concentration to total FA is much higher.

It is interesting to note that after enrichment the composition of the rotifers did not differ more than a fraction of 30 to 45% in (n-3) HUFA (Fig. 3.13). Moreover, the lipid composition of the rotifers was also little affected by the composition of the diet. However, when the efficiency of DHA and (n-3) HUFA incorporation in rotifers is analyzed it is obvious that better results are obtained with the extraction products. Since all diets are consumed with approximately equal efficiency it means that

phospholipids (present in the extraction products) were more easily assimilated and metabolized by the rotifers.

Table 3.5. Fatty acid concentration in enriched rotifers (in mg.g⁻¹ DW).

Type of enrichment	EPA	DHA	DHA/EPA	(n-3) HUFA
CS	5.4	4.4	0.8	15.6
<i>Nannochloropsis</i> sp.	7.3	2.2	0.3	11.4
DHA-Super Selco	41.4	68.0	1.6	116.8
	40.6*	73.0*	1.8*	123.1*
	43.1**	46.0**	1.1**	95.0**

* Concentration after 7 h storage at 20°C
 ** Concentration after 12 h storage at 20°C

3.6.2. Techniques for vitamin C enrichment

The vitamin C content of rotifers reflects the dietary ascorbic acid (AA) levels both after culture and enrichment (Table 3.6.). For example, rotifers cultured on instant baker's yeast contain 150 mg vitamin C/g⁻¹ DW, while for *Chlorella*-fed rotifers contain 2300 mg vitamin C/g⁻¹ DW. Within commercial marine fish hatcheries a wide range of products are used for the culture and subsequent boosting of rotifers (Table 3.6.). In general commercial-scale enrichment is scoring lower than laboratory enrichment. Problems of operculum deformities currently occurring in Mediterranean gilthead seabream hatcheries might be related to the changes in live food production management and reduced vitamin C levels.

Enrichment of rotifers with AA is carried out using ascorbyl palmitate (AP) as a source of vitamin C to supplement the boosters. AP is converted by the rotifers into active AA up to 1700 mg.g⁻¹ DW after 24 h enrichment using a 5 % AP (w/w) emulsion (Fig. 3.15.). The storage of rotifers in seawater after culture or enrichment has no effect on the AA content during the first 24 h (Fig. 3.15.), indicating that the rotifers maintain their nutritional value when fed to the larval fish during the culture run.

Table 3.6. Ascorbic acid content (mg.g⁻¹ DW) of rotifers cultured on a laboratory and hatchery scale (modified from Merchie *et al.*, 1995).

culture / enrichment diet		
lab scale	culture (3 d)	enrichment (6 h)
<i>Chlorella</i> / <i>Isochrysis</i>	2289	2155
baker's yeast / <i>Isochrysis</i>	148	1599
Culture Selco ^{®1} / Protein Selco ^{®1}	322	1247
commercial scale	culture (5-7 d)	enrichment (6-24 h)
baker's yeast + <i>Chlorella</i> / <i>Chlorella</i>	928	1255
baker's yeast + <i>Nannochloris</i> / <i>Nannochloris</i>	220	410
Culture Selco [®] / Protein Selco ^{®1}	136	941
Culture Selco ^{®1} / <i>Isochrysis</i>	327	1559
¹ vit C -boosted, Inve Aquaculture N.V.		

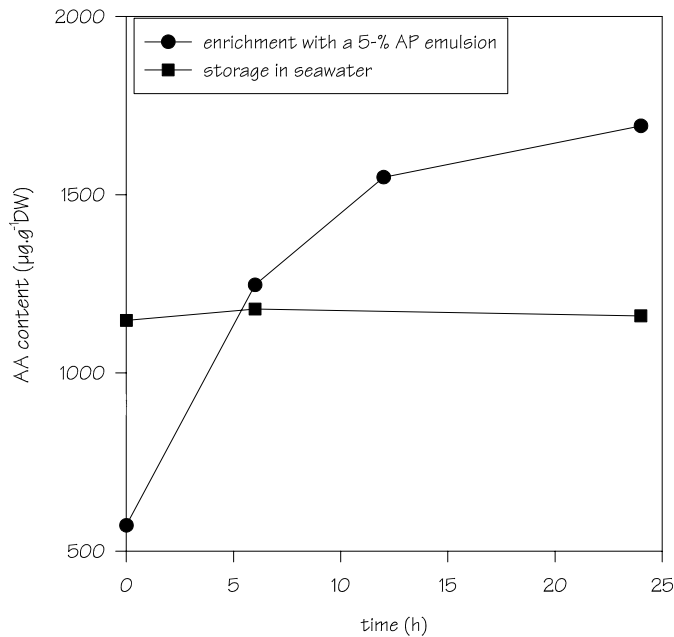

Figure 3.15. Ascorbic acid levels in rotifers after enrichment (●) and subsequent storage in seawater (■)

3.6.3. Techniques for protein enrichment

To our knowledge Protein Selco® is the only enrichment diet especially designed for protein enrichment in rotifers. The high levels of proteins allow the cultures to continue to grow and to develop during the enrichment period. Normally it is used in the same way as an oil emulsion (blended in a kitchen blender) and distributed in the tank at a concentration of 125 mg.l⁻¹ seawater at two time intervals of 3 to 4 hours.

Table 3.7. gives a comparison of the protein content of rotifers enriched with three different enrichment strategies (A: long term enrichment during the culture with baker's yeast + 10% Super Selco®; B: short term enrichment with DHA-Selco®; C: short term enrichment with Protein Selco®). Dry weight is significantly higher in rotifers enriched with Protein Selco® and similar for A and B. The protein level is significantly higher for C than B rotifers, but no significant difference can be observed between the protein level of A and C rotifers. Lipid levels are significantly higher for C than for A rotifers, but no difference can be found between C and B rotifers. A rotifers have the highest protein/lipid ratio and B the lowest ratio (Øie *et al.*, 1996).

Table 3.7. Dry weight (DW), protein and lipid levels of rotifers enriched with different diets (modified from Øie *et al.*, 1996).

	Long term Selco® enrichment	Short term DHA-Selco® enrichment	Short term Protein Selco® enrichment
ng protein.ind ^{-1*}	200 ± 31	163 ± 13	238 ± 44
ng protein.ind ^{-1**}	117	100	165
protein /lipid*	3.7	2.3	2.6
protein/lipid**	2.2	1.4	1.8
ng DW.ind ⁻¹	376 ± 20	331 ± 13	502 ± 33

*protein expressed as N x 6.25
** protein expressed as sum amino acids

Fig. 3.16. illustrates the range in amino acid content in individual rotifers. It is clear from this figure that for most amino acids rotifers are quite conservative even when they are exposed to starvation conditions.

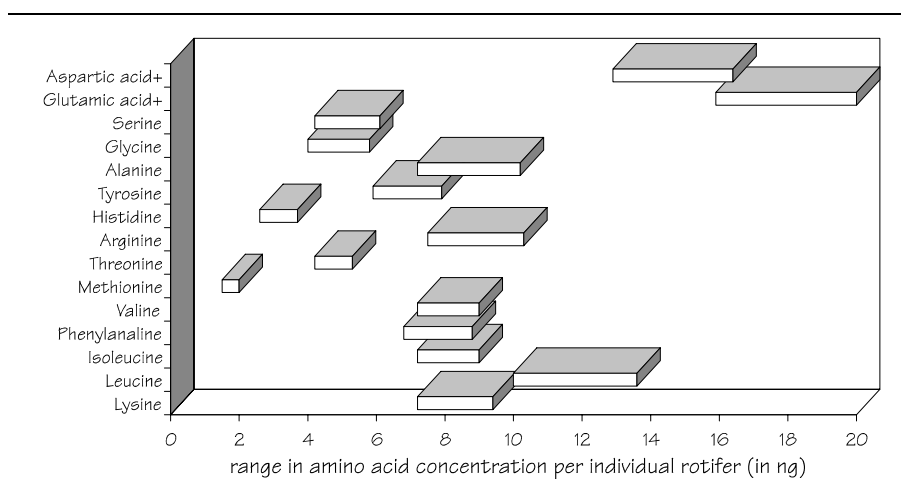

Figure 3.16. Ranges in amino acid concentration for starved (lower value) and well-fed (higher value) rotifers (Makridis and Olsen, pers. comm.).

3.6.4. Harvesting/concentration and cold storage of rotifers

As explained earlier, the harvesting and concentrating of non-enriched rotifers should be performed in submerged filters (see 3.5.4.). Harvesting of enriched rotifers should be carried out with extreme care in order to prevent them sticking together in clumps. Especially when the enriched animals are concentrated before the washing, aeration can easily result in clumping. Instead of pouring enriched rotifers in a bucket it is therefore recommended to siphon them so as to avoid the interference of the air bubbles.

Rotifers that can not be fed immediately need to be stored at a cold temperature (4°C) in order to prevent the reduction of their nutritional quality. During a starvation period of one day at 25°C, rotifers can lose up to 26 % of their body weight as a result of metabolic activity. Different culture and enrichment procedures also influence the effect of starvation. For example, the starvation of gut-enriched rotifers (*i.e.*, rotifers boosted with oil emulsions, microparticulated diets or microalgae) immediately before feeding to the predator (indirect enrichment procedure, short term enrichment) results in a very fast loss of their fatty acid content, as the animals start to empty their guts after 20 to 30 min! After about 6 hours in the larval rearing tanks, the rotifer HUFA content may have dropped to 1/3 of its original level. Tissue enrichment (direct enrichment procedure, long term enrichment), on the other hand takes place during the rotifer culture, and allows a slow but steady increase in the fatty acid content of the rotifers. This reserve in fatty acids is thus more stable and less exposed to fast decrease by starvation.

3.7. Production and use of resting eggs

For the mass rearing of rotifers as larval food the amictic way of reproduction (see 3.3.) should be favored. However, when the interest is in production of resting eggs for use as a storable off-the-shelf product mixis needs to be induced. These resting eggs, also called cysts, are relatively large (their volume is almost 60% of that of a normal adult female, Fig. 3.17.), are ideal for storage and transport and can be used as inocula for mass cultures. Mass production of rotifers for cyst production is performed in batch cultures in concrete tanks (Hagiwara *et al.*, 1995; Dhert *et al.*, 1995) or resting eggs are collected from sediments in earthen ponds. Resting egg production can be induced by limiting the food supply or changing the temperature and/or salinity. Resting eggs will sink and need to be harvested from the bottom. In case a lot of waste is trapped at the bottom it is advised to replace the water by brine so that resting eggs will float and can be collected from the water surface. If the sediment on the bottom is too important, to collect the resting eggs the water needs to be replaced by brine and the resting eggs will come to the surface from where they can be harvested. Dry resting eggs can be stored for more than one year. When placed in seawater, rotifer cysts hatch in about 24 hours at 25°C under light conditions. Newly-hatched rotifers undergo asexual reproduction.

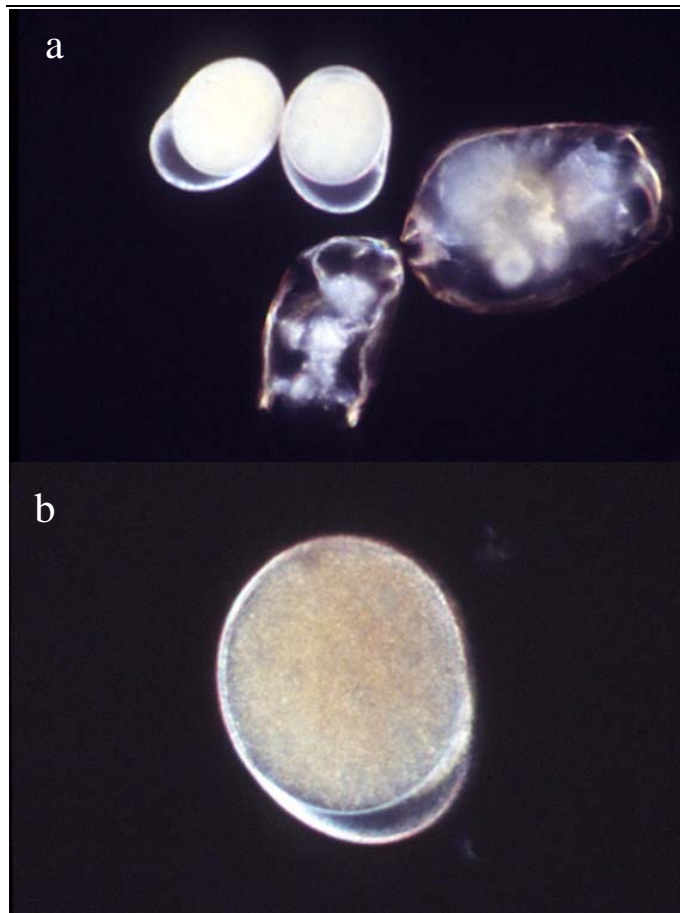

Figure 3.17. Microscopic view of resting eggs (length 100-170 μm ; a. at same magnification as two amictic females; b. at high magnification)

There are several advantages of using rotifer cysts to initiate mass cultures. The use of stock cultures is not required which considerably reduces labor cost and algal production costs. Moreover, the upscaling from stock culture to production unit can be considerably reduced by the use of larger numbers of cysts. The use of cysts is also highly recommended to prevent contamination. Cysts can easily be treated before hatching in order to ensure start cultures free from bacteria and ciliates. The resting eggs could be disinfected with heavy doses of antibiotics, so that the emerging rotifers are essentially bacteria free. The resting eggs can also resist short exposure to disinfectants such as NaOCl or glutaraldehyde.

3.8. Literature of interest

- Dhert, Ph., Schoeters, K., Vermeulen, P., Sun, J., Gao, S., Shang, Z. and Sorgeloos, P. 1995. Production and evaluation of resting eggs of *Brachionus plicatilis* originating from the P.R. of China. In: Lavens, P.; E. Jaspers and I. Roelants (Eds.), Larvi'95 Fish and Shellfish Larviculture Symposium. European Aquaculture Society, Special Publication, Gent, Belgium, 24:315-319.
- Fu, Y, Hirayama, K. and Natsukari, Y. 1991. Morphological differences between two types of the rotifer *Brachionus plicatilis* O.F. Müller. J. Exp. Mar. Biol. Ecol., 151:29-41.
- Fukusho, K. 1989. Biology and mass production of the rotifer, *Brachionus plicatilis*. Int. J. Aq. Fish. Technol., 1:232-240.
- Fukusho, K. and Iwamoto, H. 1981. Polymorphosis in size of rotifer, *Brachionus plicatilis*, cultured with various feeds. Bull. Nat. Res. Inst. Aquaculture, 2:1-10.
- Gatesoupe, F.J. 1991. The effect of three strains of lactic bacteria on the production rate of rotifers, *Brachionus plicatilis*, and their dietary value for larval turbot, *Scophthalmus maximus*. Aquaculture, 96:335-342.
- Hagiwara, A., Balompapueng, M.D. and Hirayama, K. 1995. Mass production and preservation of marine rotifer resting eggs. Page 314. In: Lavens, P.; E. Jaspers and I. Roelants (Eds.), Larvi'95 Fish and Shellfish Larviculture Symposium. European Aquaculture Society, Special Publication, Gent, Belgium, 24:314.
- Hirata, H. 1979. Rotifer culture in Japan. In: Styczynska-Jurewicz, E.; T. Backiel; E. Jaspers and G. Persoone (Eds), Cultivation of fish fry and its live food. European Mariculture Society, Special Publication, 4:361-375.
- Hirayama, K. 1987. A consideration of why mass culture of the rotifer *Brachionus plicatilis* with baker's yeast is unstable. Hydrobiologia, 147:269-270.
- Hoff, F.H. and Snell, T.W. 1987. Plankton culture manual, First edition, Florida Aqua Farms, Inc., Florida, USA 126 pp.
- Koste, W. 1980. Das rädertier-porträt. *Brachionus plicatilis*, ein salzwasserrädertier. Mikrokosmos, 5:148-155.
- Léger, P., Grymonpre, D., Van Ballaer, E. and Sorgeloos, P. 1989. Advances in the enrichment of rotifers and *Artemia* as food sources in marine larviculture. In: Aquaculture Europe'89, Short Communications and Abstracts, Special Publication, 10:141-142.
- Lubzens, E. 1987. Raising rotifers for use in aquaculture. Hydrobiologia, 147:245-255.
- Merchie, G., Lavens, P., Dhert, Ph., Deshasque, M., Nelis, H., De-Leenheer, A. and Sorgeloos, P. 1995. Variation of ascorbic acid content in different live food organisms. Aquaculture, 134(3-4):325-337.
- Øie, G., Makridis, P., Reitan, K.I. and Olsen, Y. 1996. Survival and utilization of carbon and protein in turbot larvae fed rotifers with different protein, lipid and protein/lipid ratio. Aquaculture (in press).

- Reitan, K.I., Rainuzzo, J.R. and Olsen, Y. 1994. Influence of lipid composition of live feed on growth, survival and pigmentation of turbot larvae. *Aquaculture International*, 2:33-48.
- Skjermo, J. and Vadstein, O., 1993. Characterization of the bacterial flora of mass cultivated *Brachionus plicatilis*. *Hydrobiologia*, Vol. 255/256:185-191.
- Verdonck, L., Swings, J., Kesters, K., Dehasque, M., Sorgeloos, P. and Léger, P. 1994. Variability of the microbial environment of rotifer *Brachionus plicatilis* and *Artemia* production systems. *Journal of the World Aquaculture Society*, 25(1):55-59.
- Watanabe, T., Kitajima, C. and Fujita, S. 1983. Nutritional values of live organisms used in Japan for mass propagation of fish: a review. *Aquaculture*, 34:115-143.
- Watanabe, T., Ohta, M., Kitajima, C. and Fujita, S. 1982. Improvement of dietary value of brine shrimp *Artemia salina* for fish larvae by feeding them w3 highly unsaturated fatty acids. *Bulletin of the Japanese Society of Scientific Fisheries*. *Nippon Suisan Gakkaishi*, Vol. 48(12):1775-1782.
- Yu, J.P., Hino, A., Hirano, R. and Hirayama, K. 1988. Vitamin B12-producing bacteria as a nutritive complement for a culture of the rotifer *Brachionus plicatilis*. *Nippon Suisan Gakkaishi*, 54(11):1873-1880.
- Yu, J.P., Hino, A., Ushiro, M. and Maeda, M. 1989. Function of bacteria as vitamin B12 producers during mass culture of the rotifer *B. plicatilis*. *Nippon Suisan Gakkaishi*, 55(10):1799-1806.
- Yu, J.P., Hino, A., Noguchi and Wakabayashi, H. 1990. Toxicity of *Vibrio alginolyticus* on the survival of the rotifer *Brachionus plicatilis*. *Nippon Suisan Gakkaishi* 56(9):1455-1460.

3.9 Worksheets

WORKSHEET 3.1. PREPARATION OF AN INDICATOR SOLUTION FOR DETERMINATION OF RESIDUAL CHLORINE

- make in two separate bottles, a KI and a starch solution of 3 g in 100 ml deionised water
 - heat the starch solution until it becomes clear
 - dissolve in the mean time the KI
 - stock the two labelled bottles in the refrigerator
 - to check the presence of chlorine, put a few drops of each solution in a small sample
 - if your sample turns blue, chlorine is still present
-

4. ARTEMIA

4.1. Introduction, biology and ecology of *Artemia*

Gilbert Van Stappen

Laboratory of Aquaculture & Artemia Reference Center
University of Gent, Belgium

4.1.1. Introduction

Among the live diets used in the larviculture of fish and shellfish, nauplii of the brine shrimp *Artemia* constitute the most widely used food item. Annually, over 2000 metric tons of dry *Artemia* cysts are marketed worldwide for on-site hatching into 0.4 mm nauplii. Indeed, the unique property of the small branchiopod crustacean *Artemia* to form dormant embryos, so-called 'cysts', may account to a great extent to the designation of a convenient, suitable, or excellent larval food source that it has been credited with. Those cysts are available year-round in large quantities along the shorelines of hypersaline lakes, coastal lagoons and solar saltworks scattered over the five continents. After harvesting and processing, cysts are made available in cans as storable 'on demand' live feed. Upon some 24-h incubation in seawater, these cysts release free-swimming nauplii that can directly be fed as a nutritious live food source to the larvae of a variety of marine as well as freshwater organisms, which makes them the most convenient, least labour-intensive live food available for aquaculture. Although *Artemia* has been known to man for centuries, its use as a food for the culture of larval organisms apparently began only in the 1930s, when several investigators found that it made an excellent food for newly-hatched fish larvae. During the 1940s, most commercially available brine shrimp cysts represented collections from natural saline lakes and coastal saltworks. With the growing interest for tropical hobby fish in the late 1940s, commercial value was attached to brine shrimp, thereby establishing a new industry. Early pioneers exploited in 1951 the cyst production of *Artemia* at the Great Salt Lake in Utah, USA. First harvests of the lake yielded 16 tons of finished product. During the mid-1950s, commercial attention for brine shrimp was turned to controlled sources for production in the San Francisco Bay region. Here it was found that brine shrimp and their cysts could be produced as a by-product of solar saltworks. Since salt production entails management of the evaporation process, yearly cyst and biomass productions could be roughly predicted. In the 1960s, commercial provisions originated from these few sources in North America and seemed to be unlimited. However, with the expansion of aquaculture production in the 1970s, the demand for *Artemia* cysts soon exceeded the offer and prices rose exponentially, turning *Artemia* into a bottleneck for the expansion of the hatchery aquaculture of marine fishes and crustaceans. In particular, many developing countries could hardly afford to import the very expensive cysts.

At the Kyoto FAO Technical Conference on Aquaculture in 1976 it was claimed that the cyst shortage was an artificial and temporary problem. During the following years research efforts were made to prove the possibility of local production of *Artemia* in developing countries.

At present, *Artemia* is being produced and exploited on the five continents. Despite this, a large part of the cyst market is still supplied by harvests from one location, the Great Salt Lake. This situation makes the market still extremely vulnerable to climatological

and/or ecological changes in this lake, which has been illustrated by the unusually low cyst harvests in the seasons 1993-1994 and mainly 1994-1995.

Already in the late 1970s it appeared that the nutritional value of *Artemia*, especially for marine organisms, was not constant but varied among strains and within batches of each strain, causing unreliable outputs in marine larviculture. Through multidisciplinary studies in the 1980s both the causes for the nutritional variability in *Artemia* and the methods to improve poor-quality *Artemia* were identified. Genotypic and phenotypic variation (*i.e.* cyst size, cyst hatching characteristics, caloric content and fatty acid composition of the nauplii) determine if a particular cyst product is suitable for hatchery use of specific fish or shrimp species.

By bio-encapsulating specific amounts of particulate or emulsified products rich in highly unsaturated fatty acids in the brine shrimp metanauplii, the nutritional quality of the *Artemia* can be further tailored to suit the predators' requirements. Application of this method of bio-encapsulation, also called *Artemia* enrichment or boosting, has had a major impact on improved larviculture outputs, not only in terms of survival, growth and success of metamorphosis of many species of fish and crustaceans, but also with regard to their quality, *e.g.* reduced incidence of malformations, improved pigmentation and stress resistance. The same bio-encapsulation method is now being developed for oral delivery of vitamins, chemotherapeutics and vaccines.

Furthermore, a better knowledge of the biology of *Artemia* was at the origin of the development of other *Artemia* products, such as disinfected and decapsulated cysts, various biomass preparates, which presently have application in hatchery, nursery and broodstock rearing. All these developments resulted in optimized and cost-effective applications of this live food in hatchery production.

4.1.2. Biology and ecology of *Artemia*

4.1.2.1. Morphology and life cycle

In its natural environment at certain moments of the year *Artemia* produces cysts that float at the water surface (Fig. 4.1.1.) and that are thrown ashore by wind and waves. These cysts are metabolically inactive and do not further develop as long as they are kept dry. Upon immersion in seawater, the biconcave-shaped cysts hydrate, become spherical, and within the shell the embryo resumes its interrupted metabolism. After about 20 h the outer membrane of the cyst bursts (= "breaking") and the embryo appears, surrounded by the hatching membrane (Fig. 4.1.2.). While the embryo hangs underneath the empty shell (= "umbrella" stage) the development of the nauplius is completed and within a short period of time the hatching membrane is ruptured (= "hatching") and the free-swimming nauplius is born (Fig. 4.1.3.).



Figure 4.1.1. Harvesting of brine shrimp cysts from a saltpond.

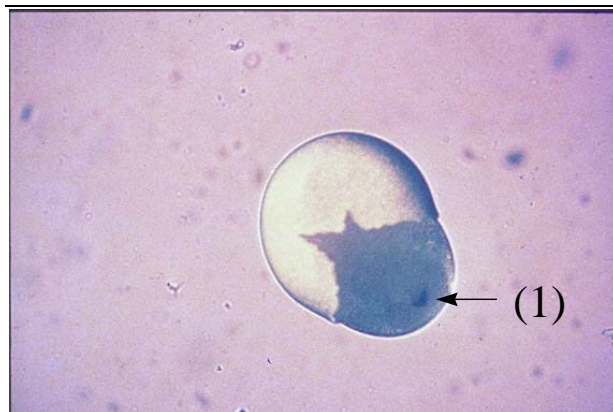

Figure 4.1.2. Cyst in breaking stage. (1) nauplius eye.

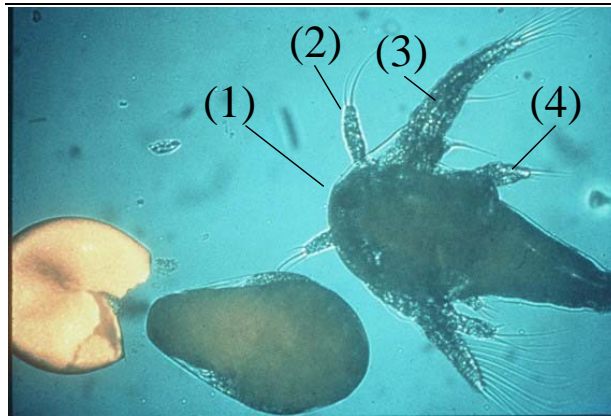

Figure 4.1.3. Embryo in “umbrella” stage (left) and instar I nauplius (right). (1) nauplius eye; (2) antennula; (3) antenna; (4) mandible.

The first larval stage (instar I; 400 to 500 μm in length) has a brownish-orange colour, a red nauplius eye in the head region and three pairs of appendages: *i.e.* the first antennae (sensorial function), the second antennae (locomotory + filter-feeding function) and the mandibles (food uptake function). The ventral side is covered by a large labrum (food uptake: transfer of particles from the filtering setae into the mouth). The instar I larva does not take up food as its digestive system is not functional yet; it thrives completely on its yolk reserves.

After about 8 h the animal molts into the 2nd larval stage (instar II). Small food particles (*e.g.* algal cells, bacteria, detritus) ranging in size from 1 to 50 μm are filtered out by the 2nd antennae and ingested into the functional digestive tract.

The larva grows and differentiates through about 15 molts. Paired lobular appendages are appearing in the trunk region and differentiate into thoracopods (Fig. 4.1.4.). On both sides of the nauplius lateral complex eyes are developing (Fig. 4.1.5. and 4.1.6.). From the 10th instar stage on, important morphological as well as functional changes are taking place: *i.e.* the antennae have lost their locomotory function and undergo sexual differentiation. In males (Fig. 4.1.6. and 4.1.8.) they develop into hooked graspers, while the female antennae degenerate into sensorial appendages (Fig. 4.1.11.). The thoracopods are now differentiated into three functional parts (Fig. 4.1.13.), namely the telopodites and endopodites (locomotory and filter-feeding), and the membranous exopodites (gills).

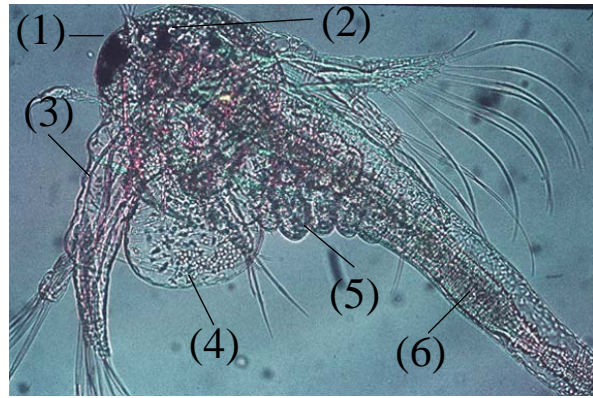

Figure 4.1.4. Instar V larva. (1) nauplius eye; (2) lateral complex eye; (3) antenna; (4) labrum; (5) budding of thoracopods; (6) digestive tract.

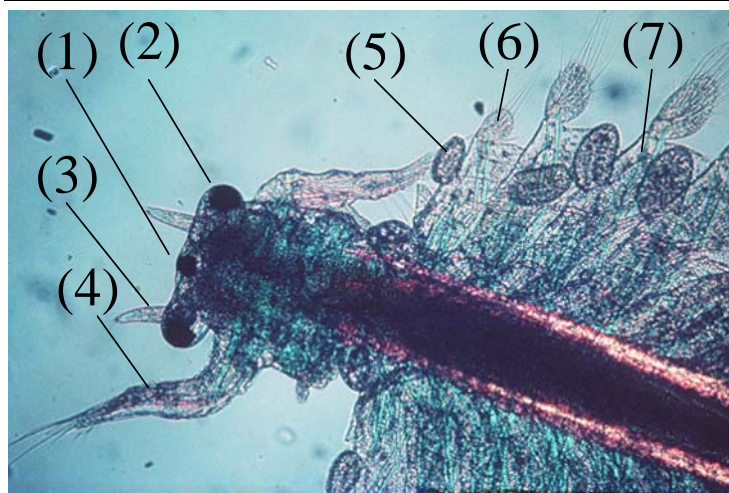

Figure 4.1.5. Head and anterior thoracic region of instar XII. (1) nauplius eye; (2) lateral complex eye; (3) antennula; (4) antenna; (5) exopodite; (6) telopodite; (7) endopodite.

Adult *Artemia* (± 1 cm in length) have an elongated body with two stalked complex eyes, a linear digestive tract, sensorial antennulae and 11 pairs of functional thoracopods (Fig. 4.1.10. and 4.1.11.). The male (Fig. 4.1.10.) has a paired penis in the posterior part of the trunk region (Fig. 4.1.9.). Female *Artemia* can easily be recognized by the brood pouch or uterus situated just behind the 11th pair of thoracopods (Fig. 4.1.9. and 4.1.11.). Eggs develop in two tubular ovaries in the abdomen (Fig. 4.1.7.). Once ripe they become spherical and migrate via two oviducts into the unpaired uterus.

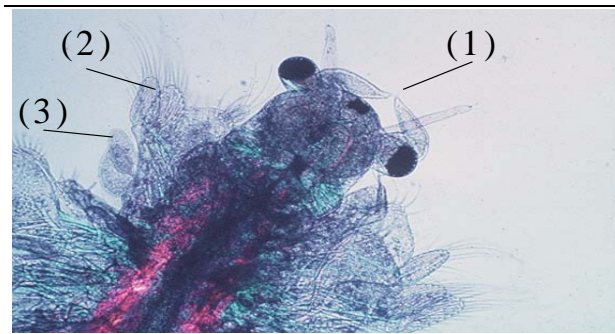

Figure 4.1.6. Head and thoracic region of young male. (1) antenna; (2) telopodite; (3) exopodite.



Figure 4.1.7. Posterior thoracic region, abdomen and uterus of fertile female. (1) ripe eggs in ovary and oviduct.

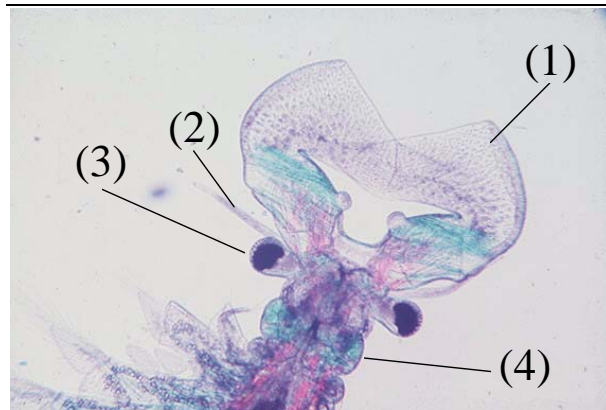

Figure 4.1.8. Head of an adult male. (1) antenna; (2) antennula; (3) lateral complex eye; (4) mandible.

Fertilized eggs normally develop into free-swimming nauplii (= ovoviviparous reproduction) (Fig. 4.1.12.) which are released by the mother. In extreme conditions (e.g. high salinity, low oxygen levels) the embryos only develop up to the gastrula stage. At this moment they get surrounded by a thick shell (secreted by the brown shell glands located in the uterus), enter a state of metabolic standstill or dormancy (diapause) and are then released by the female (= oviparous reproduction) (Fig. 4.1.14.). In principle both oviparity and ovoviviparity are found in all *Artemia* strains, and females can switch in-between two reproduction cycles from one mode of reproduction to the other. The cysts usually float in the high salinity waters and are blown ashore where they accumulate and dry. As a result of this dehydration process the diapause mechanism is generally inactivated; cysts are now in a state of quiescence and can resume their further embryonic development when hydrated in optimal hatching conditions.

Under optimal conditions brine shrimp can live for several months, grow from nauplius to adult in only 8 days' time and reproduce at a rate of up to 300 nauplii or cysts every 4 days.

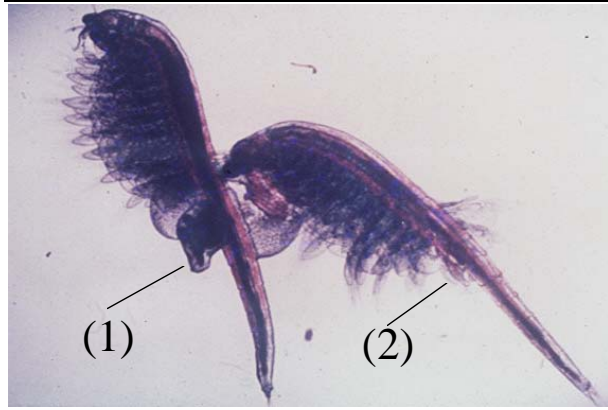

Figure 4.1.9. *Artemia* couple in riding position. (1) uterus; (2) penis.

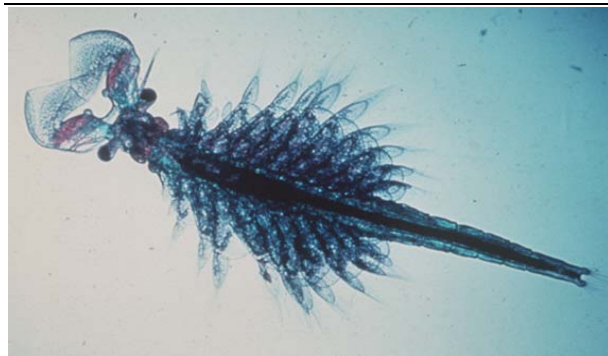

Figure 4.1.10. Adult male.

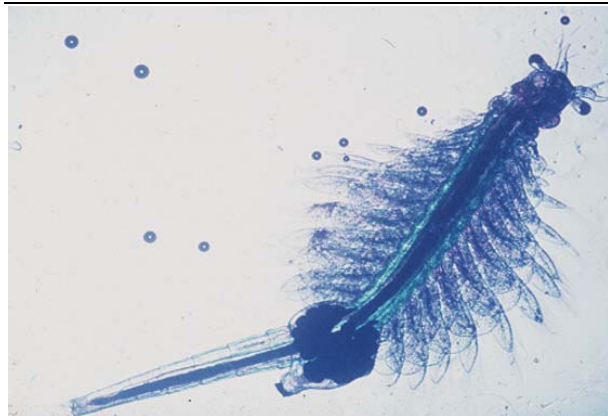

Figure 4.1.11. Adult female.

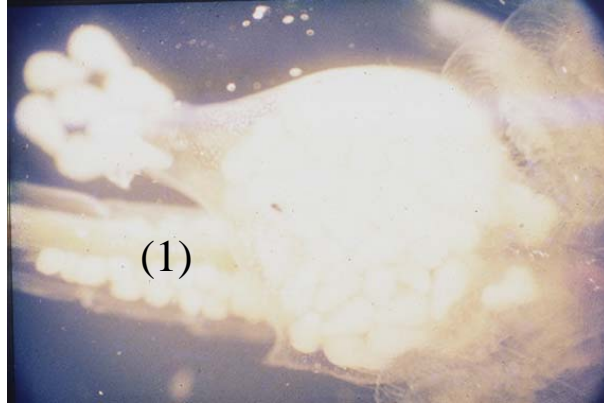

Figure 4.1.12. Uterus of ovoviviparous *Artemia* filled with nauplii (first larvae are being released). (1) ovary with eggs.

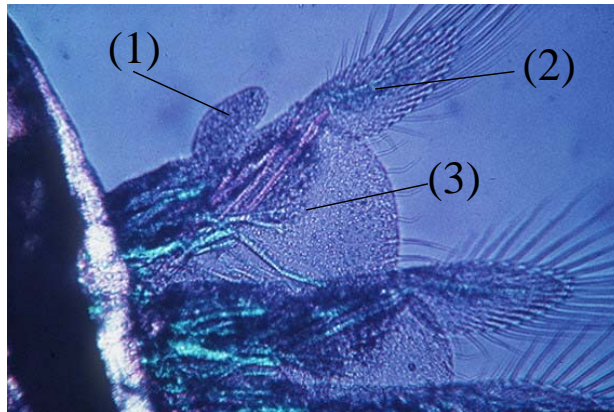

Figure 4.1.13. Detail of anterior thoracopods in adult *Artemia*. (1) exopodite; (2) telopodite; (3) endopodite.

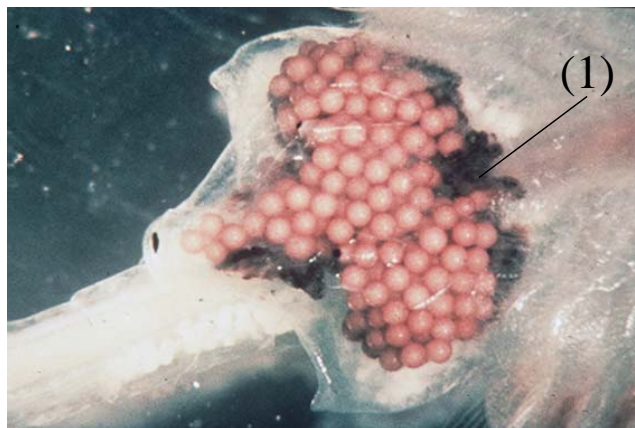

Figure 4.1.14. Uterus of oviparous *Artemia* filled with cysts. (1) brown shell glands (darker colour).

4.1.2.2. Ecology and natural distribution

Artemia populations are found in about 500 natural salt lakes and man-made salterns scattered throughout the tropical, subtropical and temperate climatic zones, along coastlines as well as inland (Fig. 4.1.15.). This list still remains provisional as more extensive survey work should lead to the discovery of many more *Artemia* biotopes in different parts of the world (Table 4.1.1.). The distribution of *Artemia* is discontinuous: not all highly saline biotopes are populated with *Artemia*. Although brine shrimp thrive very well in natural seawater, they cannot migrate from one saline biotope to another via the seas, as they depend on their physiological adaptations to high salinity to avoid predation and competition with other filter feeders. Its physiological adaptations to high salinity provide a very efficient ecological defense against predation, as brine shrimp possess:

- a very efficient osmoregulatory system;
- the capacity to synthesize very efficient respiratory pigments to cope with the low O₂ levels at high salinities;
- the ability to produce dormant cysts when environmental conditions endanger the survival of the species.

Artemia therefore, is only found at salinities where its predators cannot survive ($\geq 70 \text{ g.l}^{-1}$). As a result of extreme physiological stress and water toxicity *Artemia* dies off at salinities close to NaCl saturation, *i.e.* 250 g.l^{-1} and higher.

Different geographical strains have adapted to widely fluctuating conditions with regard to temperature (6-35°C), salinity and ionic composition of the biotope. Thalassohaline waters are concentrated seawaters with NaCl as major salt. They make up most, if not all, of the coastal *Artemia* habitats where brines are formed by evaporation of seawater in salt pans. Other thalassohaline habitats are located inland, such as the Great Salt Lake in Utah, USA. Athalassohaline *Artemia* biotopes are located inland and have an ionic composition that differs greatly from that of natural seawater: there are sulphate waters (*e.g.* Chaplin Lake, Saskatchewan, Canada), carbonate waters (*e.g.* Mono Lake, California, USA), and potassium-rich waters (*e.g.* several lakes in Nebraska, USA).

Artemia is a non-selective filter feeder of organic detritus, microscopic algae as well as bacteria. The *Artemia* biotopes typically show a very simple trophical structure and low species diversity; the absence of predators and food competitors allows brine shrimp to develop into monocultures. As high salinity is the common feature determining the presence of *Artemia*, the impact of other parameters (temperature, primary food production, *etc.*) may at most affect the abundance of the population and eventually cause a temporary absence of the species.

As *Artemia* is incapable of active dispersion, wind and waterfowl (especially flamingos) are the most important natural dispersion vectors; the floating cysts adhere to feet and feathers of birds, and when ingested they remain intact for at least a couple of days in the digestive tract of birds. Consequently the absence of migrating birds is probably the reason why certain areas that are suitable for *Artemia* (*e.g.* salinas along the northeast coast of Brazil) are not naturally inhabited by brine shrimp.

Next to the natural dispersion of cysts, deliberate inoculation of *Artemia* in solar salt works by man has been a common practice in the past. Since the seventies man has been responsible for several *Artemia* introductions in South America and Australia, either for salt production improvement or for aquaculture purposes. Additionally, temporal *Artemia* populations are found in tropical areas with a distinct wet and dry season (monsoon climate), through inoculation in seasonal salt operations (e.g. Central America, Southeast Asia).

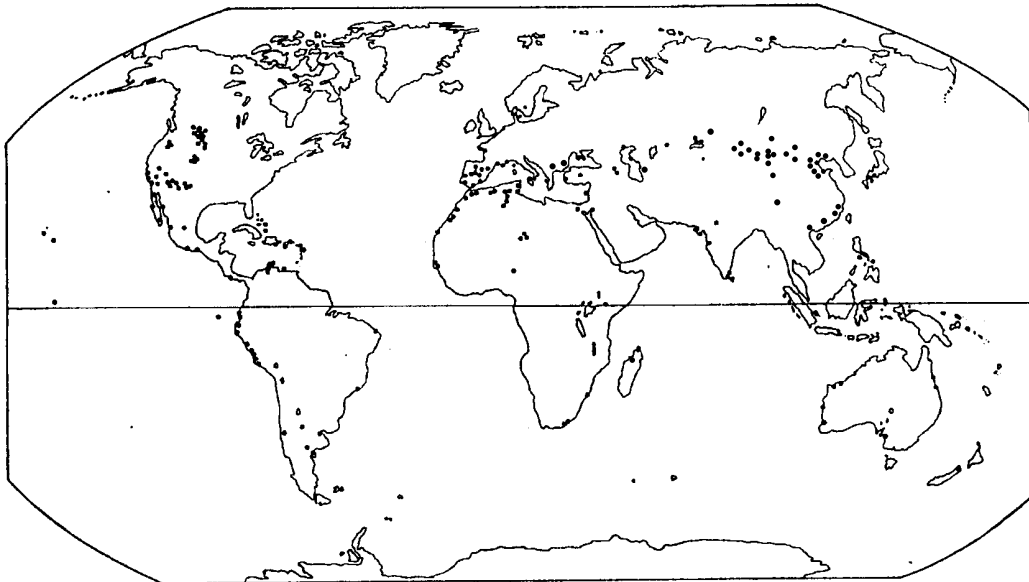

Figure 4.1.15. The world distribution of *Artemia*.

Table 4.1.1. World distribution of <i>Artemia</i>.			
Country	Locality	Sex	Species
<i>Artemia</i> sites in Africa			
Algeria	Chegga Oase	---	---
	Chott Djeloud	---	---
	Chott Ouargla	---	---
	Dayet Morselli	---	---
	Gharabas Lake	---	---
	Sebket Djendli	---	---
	Sebket Ez Zemouk	---	---
	Sebket Oran	---	---
	Tougourt	---	---
Egypt	Port Fouad	B	<i>A. sal</i>
	Wadi Natron	B	<i>A. sal</i>
	Qarun Lake	P	<i>A. par</i>
	Elmenteita	---	---
Kenya			
Libya	Mandara	B	<i>A. sp</i>
	Ramba-Az-Zallaf (Fezzan)	---	---
	Quem el Ma	---	---
	Trouna	---	---
	Gabr Acun (Fezzan)	---	---
Madagascar	Salins de Diego Suarez	---	---
	Ankiembe saltworks	P(3n)	<i>A. par</i>
	Ifaty saltworks	B	<i>A. fra</i>
Morocco	Larache	P	<i>A. par</i>
	Moulaya estuary	---	---
	Qued Ammafatma	---	---
	Qued Chebeica	---	---
	Sebket Bon Areg	---	---
	Sebket Zima	---	---
Mozambique	Lagua Quissico	P	<i>A. par</i>
Namibia	Vineta Swakopmund	P(2n,4n)	<i>A. par</i>
Niger	Teguidda In Tessoun	---	---
Senegal	Dakar	---	---
	Lake Kayar	---	---
	Lake Retba	---	---
	Couga Salt Flats	---	---
South Africa	Swartkops	---	---
Tunisia	Bekalta	B	<i>A. sal</i>
	Chott Ariana	B	<i>A. sal</i>
	Chott El Djerid	---	---
	Megrine	B	<i>A. sal</i>
	Sebket Kowezia	---	---
	Sebket mta Moknine	B	<i>A. sal</i>
	Sebket Sidi el Hani	---	---
	Sfax	B	<i>A. sal</i>
<i>Artemia</i> sites in Australia and New Zealand			
New Zealand	Lake Grassmere	B	<i>A. fra</i>
Queensland	Bowen	---	---
	Port Alma	B	<i>A. fra</i>
	Rockhampton	B	<i>A. fra</i>

Table 4.1.1. (contd.) World distribution of <i>Artemia</i>.			
Country	Locality	Sex	Species
South Australia	Dry Creek, Adelaide	P	A. par
West Australia	Dampier	---	---
	Lake Mc Leod	---	---
	Port Hedland	P	A. par
	Rottneest Island	P	A. par
	Shark Bay	P,B	A.par,A.fra
<i>Artemia</i> sites in North America			
Canada	Akerlund Lake	B	A. sp
	Alsask Lake	B	A. sp
	Aroma Lake	B	A. sp
	Berry Lake	B	A. sp
	Boat Lake	B	A. sp
	Burn Lake	B	A. sp
	Ceylon Lake	B	A. sp
	Chain Lake	B	A. sp
	Chaplin Lake	B	A. fra
	Churchill	B	A. sp
	Coral Lake	B	A. sp
	Drybore Lake	B	A. sp
	Enis Lake	B	A. sp
	Frederick Lake	B	A. sp
	Fusilier Lake	B	A. sp
	Grandora Lake	B	A. sp
	Gull Lake	B	A. sp
	Hatton Lake	B	A. sp
	Horizon Lake	B	A. sp
	Ingerbright Nath	B	A. sp
	Landis Lake	B	A. sp
	La Perouse	B	A. sp
	Little Manitou Lake	B	A. fra
	Lydden Lake	B	A. sp
	Mawer Lake	B	A. sp
	Meacham Lake	B	A. sp
	Muskiki Lake	B	A. sp
	Neola Lake	B	A. sp
	Oban Lake	B	A. sp
	Richmond Lake	B	A. sp
	Shoe Lake	B	A. sp
	Snakehole Lake	B	A. sp
	Sybouts Lake-East	B	A. sp
	Sybouts Lake-West	B	A. sp
	Verlo West	B	A. sp
	Vincent Lake	B	A. sp
Wheatstone Lake	B	A. sp	
Whiteshore Lake	B	A. sp	
USA Arizona	Kiatuthlana Red Pond	B	A. fra
	Kiatuthlana Green Pond	B	A. fra

Table 4.1.1. (contd.) World distribution of *Artemia*.

Country	Locality	Sex	Species	
USA California	Carpinteria Slough	B	A. sp	
	Chula Vista	B	A. sp	
	Mono Lake	B	A.f.mon	
	Moss Landing, Monterey Bay	B	A. fra	
	Owens Lake	B	A. sp	
	San Diego	B	A. sp	
	San Francisco Bay	B	A. fra	
	San Pablo Bay	B	A. fra	
	Vallejo West Pond	B	A. sp	
USA Hawaii	Christmas Islands	B	A. sp	
	Hanapepe	B	A. sp	
	Laysan Atoll	B	A. fra	
USA Nebraska	Alkali Lake	B	A. sp	
	Ashenburger Lake	B	A. sp	
	Antioch (Potash)Lake	B	A. fra	
	Cook Lake	B	A. sp	
	East Valley Lake	B	A. sp	
	Grubny Lake	B	A. sp	
	Homestead Lake	B	A. sp	
	Jesse Lake	B	A.fra	
	Johnson Lake	B	A. sp	
	Lilly Lake	B	A. sp	
	Reno Lake	B	A. sp	
	Richardson Lake	B	A. fra	
	Ryan Lake	B	A. sp	
	Sheridan County Lake	B	A. sp	
	Sturgeon Lake	B	A. fra	
USA Nevada	Fallon Pond	B	A. fra	
USA North Dakota	Miller Lake	B	A. sp	
	Stink (Williams) Lake	B	A. sp	
USA New Mexico	Laguna del Perro	B	A. sp	
	Loving Salt Lake	B	A. sp	
	Quemado	B	A. fra	
	Zuni Salt Lake	B	A. fra	
USA Oregon	Lake Abert	B	A. sp	
USA Texas	Cedar Lake	B	A. fra	
	McKenzies Playa	B	A. sp	
	Mound Playa	B	A. sp	
	Playa Thahoka	B	A. sp	
	Raymondville	B	A. sp	
	Rich Playa	B	A. sp	
	Snow drop Playa	B	A. sp	
	Great Salt Lake	B	A. fra	
USA Utah	Cameron Lake	B	A. fra	
	Deposit Thirteen	B	A. fra	
	Penley Lake	B	A. fra	
	USA Washington	Hot (Bitter) Lake	B	A. fra

Table 4.1.1. (contd.) World distribution of *Artemia*.

Country	Locality	Sex	Species
	Omak Plateau	B	A. sp
	Soap Lake	B	A. sp
<i>Artemia</i> sites in Central America			
Bahamas	Great Inagua	B	A. sp
	Long Island	B	A. sp
	San Salvador	B	A. sp
Brit. Virgin Islands	Anegada	B	A. sp
Carribbean Islands	Antigua	B	A. sp
	St. Kitts	B	A. sp
	St. Martin	B	A. sp
	South Caicos	B	A. sp
Costa Rica	Gulfo Nicova	B	A. sp
	Bahia salinas, Guanacaste	B	A. fra
Dominican Republic	Isla Cabra	B	A. sp
	Las Calderas	B	A. sp
	Monte Cristi	B	A. sp
	Puerto Alejandro	B	A. sp
	Punta Salinas	B	A. sp
Haiti	Grandes salines	B	A. fra
Mexico Baja Calif. Norte	San Quintin	B	A. fra
Mexico Baja Calif. Sur	Pichilingue, La Paz	B	A. fra
	Guerrero Negro	B	A. fra
	Isla del Carmen	B	A. fra
Mexico Sonora	Laguna de Yavaros	B	A. fra
Mexico Coahuila	Salinas 5 km SE Cuatrocieneegas	B	A. sp
Mexico Chiapas	Laguna del Mar Muerto	B	A. sp
	La Joya	B	A. sp
	Buнавista	B	A. sp
	Los Palos	B	A. sp
	Solo Dios	B	A. sp
	Carretas	B	A. sp
	Pereyra	B	A. sp
	Chanchuto	B	A. sp
	Panzacola	B	A. sp
Mexico Estado de Mexico	Brine El Caracol, Sosa Texcoco	B	A. sp
Mexico Oaxaca	Ponds W. Salina Cruz	B	A. sp
Mexico San Luis Potosi	Las Salinas	B	A. sp
Mexico Sinaloa	Bahia de Ceuta	B	A. sp
Mexico Yucatan	San Crisanto	B	A. sp
	Celestun	B	A. sp
	Chuburna	B	A. sp
	Xtampu	B	A. sp
	Las Coloradas	B	A. sp
Netherlands Antilles	Aruba	B	A. sp
	Bonaire Duinmeer	B	A. fra
	Gotomeer	B	A. sp

Table 4.1.1. (contd.) World distribution of *Artemia*.

Country	Locality	Sex	Species
	Pekelmeer	B	A. sp
	Martinus	B	A. sp
	Slagbaai	B	A. sp
	Curaçao Fuik	B	A. sp
	Rifwater	B	A. sp
Nicaragua	Salinas Grandes, Leon	B	A. fra
Puerto Rico	Bahia Salinas	B	A. fra
	Bogueron	B	A. sp
	Cabo Rojo	B	A. sp
	La Parguera	B	A. sp
	Ponce	B	A. sp
	Tallaboa salterns	B	A. fr
<i>Artemia</i> sites in South America			
Argentina	Bahia Blanca	B	A. sp
	Buenos Aires	B	A. per
	Hidalgo	B	A. per
Bolivia	Mar Chiquita	B	A. sp
	Lake Canapa	B	A. sp
	Lake Chulluncani	B	A. sp
	Lake Hedonia	B	A. sp
	Lake Poopo	B	A. sp
Brazil	Aracati	B	A. sp
	Cabo Frio	B	A. fra
	Fortaleza	B	A. sp
	Icapui	B	A. sp
	Macau	B	A. fra
	Mundau	B	A. sp
Chile	Salar de Surire	B	A. sp
	Playa Yape (Iquique)	B	A. sp
	Salar de Pintados (I Region)	B	A. sp
	Salar de Llamara (II Region)	B	A. sp
		B	A. fra
	Puerto Viejo (Copiapo)	B	A. sp
	La Pampilla (Coquimbo)	B	A. sp
	Palo Colorado (Los Vilos)	B	A. sp
	Salinas de Cahuil (Pichilemu)	B	A. sp
	Salinas de Constitución (VIIB Región)	B	A. sp
Colombia	Galerazamba	B	A. sp
	Manaure	B	A. sp
Ecuador	Galapagos (S.Salvador)	B	A. fra
	Pacoa	B	A. sp
	Salinas	B	A. sp
Peru	Caucato	B	A. sp
	Chicama	B	A. sp
	Chilca	B	A. sp
	Estuario de Virrila	B	A. sp

Table 4.1.1. (contd.) World distribution of *Artemia* .

Country	Locality	Sex	Species
Venezuela	Guadalupe	B	A. sp
	Pampa de Salinas	B	A. sp
	Pampa Playa Chica	B	A. sp
	Puerto Huarmey	B	A. sp
	Tumbes	B	A. sp
	Boca Chica	B	A. sp
	Coya Sal	B	A. sp
	Coche	B	A. sp
	Coro Coastline	B	A. sp
	La Orchila	B	A. sp
	Las Aves	B	A. sp
	Los Roques	B	A. sp
	Port Araya	B	A. sp
	Tucacas	B	A. sp
<i>Artemia</i> sites in Asia			
P.R. China Liaoning	Jinzhou	P	A. par
	Yingkou	P(2,4,5n)	A. par
	Dongjiagou	P(2n)	A. par
	Pulandian	P(2n)	A. par
	Lushun	P(2,4,5n)	A. par
	Fuzhouwan	P	A. par
P.R. China Hebei	Nanpu	P(2n)	A. par
	Luannan	P	A. par
	Daqinghe	P	A. par
	Huanghua	P(2n)	A. par
	Shangyi	B	A. sin
	Zhangbei	B	A. sin
	Kangbao	B	A. sin
P.R. China Tianjin	Hangu	P(2n)	A. par
	Tanggu	P(2,4,5n)	A. par
P.R. China Shandong	Chengkou	P(2n)	A. par
	Yangkou	P(2n)	A. par
	Dongfeng	P(2,5n)	A. par
	Gaodao	P	A. par
	Xiaotan	P	A. par
P.R. China Jiangsu	Nanwan	P	A. par
	Jimo	P	A. par
	Xuyu	P	A. par
P.R. China Zhejiang	Lianyungang	P	A. par
	Zhanmao	P	A. par
	Shunmu	P	A. par
P.R. China Fujian	Zhujiajian	P	A. par
	Shanyao	P	A. par
	Xigang	P	A. par
P.R. China Guangdong	Huian	P	A. par
		P	A. par
P.R. China Hainan	Dongfang	P	A. par
	Yinggehai	P(2,4,5n)	A. par

Table 4.1.1. (contd.) World distribution of *Artemia*.

Country	Locality	Sex	Species
P.R. China Xinjiang	Aibi	P(2,4n)	A. par
	Dabancheng	P(2,3,4,5n)	A. par
	Balikun	P(2,4n)	A. par
	Aletai	B	A. sp
P.R. China Tibet	Yanjing	B	A. sp
	Shenzha	B	A. sp
	Bange	---	---
	Gaize	---	---
	Geji	---	---
	Zhangchaka	---	---
	Wumacuo	---	---
	Jibuchaka	---	---
	Dongcuo	---	---
	P.R. China Qinghai	Gahai	P(2n)
Xiaocaidan		P	A. par
Dacaidan		P	A. par
Suban		P	A. par
Keke		P(4n)	A. par
Chaka		P	A. par
Tuosu		P	A. par
P.R. China Gansu	Gaotai	B	A. sp
P.R. China Inner Mongolia (Y = Yimeng Area) (X = Ximeng Area)	Haolebaoji(Y)	B	A. sin
	Haotongyin(Y)	B	A. sin
	Taigemiao(Y)	B	A. sin
	Ej Jinor(X)	B	A. sin
	Beidachi(Y)	B	A. sin
	Jilantai	B	A. sin
	Wuqiangi	B	A. sin
	Shanggendalai(X)	B	A. sin
	Dagenor(X)	B	A. sin
	Bayannor(X)	B	A. sin
	Zhunsaihannor	B	A. sin
	Erendabusen	B	A. sin
	Chagannor(X)	B	A. sin
Huhetaolergai(Y)	B	A. sin	
Hangjinqi	B	A. sin	
P.R. China Ningxia		---	---
P.R. China Shaanxi	Dingbian	---	---
P.R. China Shanxi	Yuncheng	B	A. sin
India Rajasthan	Didwana	---	---
India Gujarat	Sambhar Lake	---	---
	Gulf of Kutch	P	A. par
	Balamba salterns	P	A. par
	Mithapur	P	A. par
India Bombay	Jamnagar	---	---
	Vadala	---	---

Table 4.1.1. (contd.) World distribution of *Artemia* .

Country	Locality	Sex	Species
	Bhayander	P	A. par
	Bahinder	---	---
India Madras	Kelambakkam	---	---
	Vedaranyam	---	---
India Tuticorin	Veppalodai	---	---
	Pattanamaruthur	---	---
	Spic Nagar	---	---
	Thirespuram	---	---
	Karsewar Island	---	---
	Saltwater springs	P	A. par
	Harbour	---	---
India Kanyakumari	Thamaraikulam	P	A. par
Iraq	Abu-Graib, Baghdad	P	A. par
	Basra	---	---
	Dayala	---	---
	Mahmoodia	---	---
Iran	Urmia Lake	B	A. urm
	Schor-Gol	---	---
	Shurabil	---	---
	Athlit	---	---
Israel	Eilat North	P	A. par
	Eilat South	---	---
Japan	Chang Dao	---	---
	Tamano	---	---
	Yamaguchi	P	A. par
Kuwait		---	---
Korea	Pusan	---	---
Pakistan	Karachi saltworks	P	A. par
Sri Lanka	Bundala	---	---
	Hambantota	---	---
	Palavi	---	---
	Putallam	P	A. par
Taiwan	Peinan Salina	---	---
	Beimen	B	A. sp
Turkey	Balikesir, Aivalik	---	---
	Camalti, Izmir	P	A. par
	Tuz Gollu	---	---
	Ankara Salt Lake	---	---
	Konya Karapinar-Meke Salt Lake	---	---
	Imbros	---	---
<i>Artemia</i> sites in Europe			
Bulgaria	Burgas	P	A. par
	Pomorye	---	---
Croatia	Secovlje, Portoroz	P(4n)	A. par
	Strunjan	P	A. par
	Ulcinj	P	A. par
Cyprus	Akrotiri Lake	---	---

Table 4.1.1. (contd.) World distribution of <i>Artemia</i> .			
Country	Locality	Sex	Species
	Larnaca Lake	B	A. sal
France	Aigues Mortes	P	---
	Carnac-Trinité sur Mer	---	---
	Guérande-le Croisic	P	A. par
	La Palme	---	---
	Lavalduc	P	A. par
	Mesquer-Assérac	---	---
	Porte La Nouvelle	---	---
	Salin de Berre	P	A. par
	Salin de Fos	---	---
	Salin de Giraud	P	A. par
	Salins d'Hyères	---	---
	Salin des Pesquiers	---	---
	Sète	P	A. par
Greece	Citros, Pieria	P(4n)	A. par
	Megalon Embolon, Thessaloniki	P(4n)	A. par
	Kalloni, Lesbos	P(4n)	A. par
	Polychnitos, Lesbos	P(4n)	A. par
	Mesolongi	P	A. par
	Milos Island	P	A. par
Italy	Quartu or salina di Poetto, Cagliari	B	A. sal
	Carloforte, Sardinia	B	A. sal
	Cervia, Ravenna	P(4n)	A. par
	Commachio, Ferrara	P(4n)	A. par
	Margherita di Savoia, Foggia	P(2,4n)	A. par
	Sant' Antioco, Sardinia	B	A. sal
	Santa Gilla, Sardinia	P(2n)	A. par
	Siracuse, Sicily		
	Tarquinia, Viterbo	B	A. sal
	Trapani, Sicily	B	A. sal
Portugal	Alcochete	P	A. par
	Tejo estuary	---	---
	Sado estuary	---	---
	Ria de Aveiro	---	---
	Ria de Farc	---	---
Romania	Lake Techirghiol	P	A. par
	Lacul Sârat Brâila	P	A. par
	Movila Miresii	---	---
Romania Slâric Prahova	Baia Baciului	P	A. par
Romania Slâric Prahova	Baia Neagrâ, SP	P	A. par
	Baia Verde I, SP	P	A. par
	Baia Verde II, SP	P	A. par
	Baia Verde III, SP	P	A. par
	Baia Rosie, SP	P	A. par
Romania Telega	Telega Bâi	P	A. par
	Telega II	P	A. par

Table 4.1.1. (contd.) World distribution of *Artemia*.

Country	Locality	Sex	Species
	Telega III	P	A. par
	Ocra Sibiului	P?	
	Sovata	P?	
Spain Alava	Añana	P(4n)	A. par
Spain Albacete	Petrola	P(4n)	A. par
	Pinilla	P(4n)	A. par
Spain Alicante	Bonmati, S.Pola	B,P(2,4n)	mixed
	Bras de Port, S.Pola	B	m
	Calpe	P(2n)	A. par
	La Mata	P(2n)	A. par
	Molina del Segura	B	
	Salinera Espanola, S. Pola	B	
	Villena	B	
Spain Burgos	Poza de la Sal	B	A. sp
Spain Cadiz	Sanlucar de Barrameda	P	A. par
	Dos hermanos	B, P(2n)	mixed
	San Eugenio	B, P(2n)	mixed
	San Felix	B	A. sal
	San Fernando	B	A. sal
	San Juan	B, P	mixed
	San Pablo	B, P	mixed
	Santa Leocadia	B, P	mixed
	Barbanera	B	A. sal
Spain Canary islands	Janubio, Lanzarote	P(2n)	A. par
Spain Cordoba	Encarnacion	P(4n)	A. par
	Puente Montilla	P(4n)	A. par
Spain Formentera	Salinera Espanola,	B	A. sal
Spain Guadalajara	Armalla	P(4n)	A. par
	Imon	P(4n)	A. par
	Olmeda	P(4n)	A. par
	Rienda	P(4n)	A. par
Spain Huelva	Ayamonte	P(2n)	A. par
	Lepe	P(2n)	A. par
	Isla Cristina	P(2n)	A. par
	San Juan del Puerto	B	A. sal
Spain Huesca	Rolda	P	A. par
	Peralta de la Sal	P	A. par
Spain Ibiza island	Salinera Espanola		
Spain Jaen	San Carlos		
	Don Benito		
Spain Malaga	Fuente de Piedra		
Spain Mallorca	Campos del Puerto	B	A. sal
Spain Murcia	San Pedro del Pinatar	B	A. sal
	Jumilla	B	A. sal
	sal. Punta Galera	B	A. sal
	sal. Catalana	B	A. sal
Spain Soria	Medinaceli	P(4n)	A. par
Spain Tarragona	Delta del Ebro	P(4n)	A. par

Table 4.1.1. (contd.) World distribution of *Artemia*.

Country	Locality	Sex	Species
Spain Teruel	Arcos de las Salinas	P(4n)	A. par
Spain Zaragoza	Chiprana	P(4n)	A. par
	Bujaralo	P(4n)	A. par
<i>Artemia</i> sites in former USSR			
Russia	Bolshoe Otar Mojnaksho	P	A. par
	Bolshoe Yarovoe		
	Maloe		
	Yarovoe/Mojnakshoe/Dscharylgach	P	
	Ghenicheskoe		
	Karachi Lake	P	
	Kujalnic liman		
	Mangyshlak peninsula	P	
	Schekulduk		
	Tanatar	B	
	Kulundinskoe	P	
	Soljonoe	P	
Mirabilit	P		
Kazakhstan	Bolshoe Shklo	P	
	Kurichye	P	
	Buazonsor	P	
	Mormishanskoe A	P	
	Mormishanskoe B	P	
	Kutchukskoe	P	
	Maraldi	P	
Sejten	P		
Turkmenistan		P	
Ukraina	Popovskoe (=Ojburgskoe)	P	
	Tchokrakskoe	B	
	Tobetchikskoe	P	
	Shtormovoe	B	
	Sakskoe		
	Sasyk		

P = parthenogenetic strain

B = bisexual strain

A. par = *Artemia parthenogenetica*

A. sal = *Artemia salina* (= *A. tunisiana*)

A. fr = *Artemia franciscana*

A. fr. mon = *Artemia franciscana monica*

A. per = *Artemia persimilis*

A. urm = *Artemia urmiana*

A. sin = *Artemia sinica*

A. sp = *Artemia* species (unknown)

4.1.2.3. Taxonomy

The genus *Artemia* is a complex of sibling species and superspecies, defined by the criterion of reproductive isolation. Early taxonomists assigned species names to populations with different morphologies, collected at different temperatures and salinities. Later on, the profusion of names was abandoned and all brine shrimp was referred to as *Artemia salina* Linnaeus 1758... Some authors continue this practice today. Generally, different names are assigned to reproductively isolated populations or clusters of populations:

- *A. salina* Linnaeus 1758: Lymington, England (now extinct), Mediterranean area;
- *A. tunisiana* Bowen and Sterling 1978 synonym of *A. salina*;
- *A. parthenogenetica* Barigozzi 1974, Bowen and Sterling 1978: Europe, Africa, Asia, Australia;
- *A. urmiana* Gunther 1990: Iran;
- *A. sinica* Yaneng 1989: Central and Eastern Asia;
- *A. persimilis* Piccinelli and Prosdocimi 1968: Argentina;
- *A. franciscana* superspecies: Americas, Caribbean and Pacific islands, including populations reproductively isolated in nature like *A.(franciscana) franciscana* Kellogg 1906 and *A.(franciscana) monica* Verrill 1869 (Mono Lake, California);
- *Artemia* sp. Pilla and Beardmore 1994: Kazakhstan.

The coexistence of two species in the same saline habitat is possible: mixtures of parthenogenetic and zygogenetic populations have been reported in Mediterranean salterns. In addition, commercial aquaculture ventures have seeded salterns with imported cysts on many occasions; *A. Franciscana* being introduced throughout Asia, Australia, and South America over the last 20 years. Because new populations are constantly being characterised, scientists are urged to use the denomination *Artemia* sp. unless they have sufficient biochemical, cytogenetic or morphological evidence to identify the species name.

The worldwide distribution of brine shrimp in a variety of isolated habitats, each one characterised by its own ecological conditions, has furthermore resulted in the existence of numerous geographical strains, or genetically different populations within the same sibling species; in particular the parthenogenetic *Artemia* with its di-, tri-, tetra- and pentaploid populations display a wide genotypic variation. Among these strains a high degree of genetic variability as well as a unique diversity in various quantitative characteristics have been observed. Some of these characteristics (*i.e.* the nutritional value of freshly-hatched nauplii) are phenotypical, and change from year to year or season to season. Others, however (*i.e.* cyst diameter, growth rate, resistance to high temperature) are strain specific and remain relatively constant, (*i.e.* they have become genotypical as a result of long-term adaptations of the strain to the local conditions; see chapter 4.1.2.4.

4.1.2.4. Strain-specific characteristics

INTRODUCTION

While the nutritional value can be manipulated, other qualities favourable for aquaculture use can be obtained by selection of strains and/or their cross breeds. Although until recently over 90 % of all marketed cysts originated from the Great Salt Lake, *Artemia* cysts are commercially available from various production sources in America, Asia, Australia and Europe. A knowledge of the characteristics (both genotypic and phenotypic) of a particular batch of cysts can greatly increase the effectiveness of its usage in a fish or shrimp hatchery.

SIZE AND ENERGY CONTENT

The nutritional effectiveness of a food organism is primarily determined by its ingestibility and, as a consequence, by its size and form (see further : chapter 4.3.3.). Data on biometrics of nauplii from various *Artemia* strains are given in Table 4.1.2.

Table 4.1.2. Size, individual dry weight and energy content of *Artemia* instar I nauplii from different cyst sources hatched in standard conditions (35 g.l⁻¹, 25°C)

cyst source	length (mm)	dry weight (µg)	energy content (10 ⁻³ Joule)
San Francisco Bay, CA-USA	428	1.63	366
Macau, Brazil	447	1.74	392
Great Salt Lake, UT-USA	486	2.42	541
Shark Bay, Australia	458	2.47	576
Chaplin Lake, Canada	475	2.04	448
Tanggu, Bohai Bay, PR China	515	3.09	681
Aibi Lake, PR China	515	4.55	-
Yuncheng, PR China	460	2.03	-
Lake Urmiah, Iran	497	-	-

Many strains can be differentiated on the basis of their biometrical characteristics. In spite of small variations between batches of the same strain, possibly caused by environmental and/or processing factors, generally the cyst diameter of different production batches of the same strain remains rather constant. Other biometrical characteristics such as cyst volume, cyst dry weight, instar I-naupliar length, individual naupliar weight and naupliar volume, energy content *etc.*, show a high correlation with the cyst diameter. As a consequence, biometrical parameters, in particular cyst diameter, are good tools to characterize *Artemia* strains, and to help to define the origin of unknown or even mixed cyst samples.

Some general correlations can also be made between sibling species and size: parthenogenetic *Artemia* produce large cysts, *A. tunisiana* large cysts with a thick chorion, *A. franciscana* and *A. persimilis* small or intermediate cysts with a thin chorion.

HATCHING QUALITY

Comparative studies of the hatching behaviour of cysts of different origin show a considerable variation in hatching percentage, rate and efficiency. However, none of these parameters is strain specific as they are influenced by a wide array of factors like harvesting, processing, storage and hatching techniques, as well as production conditions affecting the parental generation. For optimal use of *Artemia* in aquaculture the hatching characteristics of any batch of cysts being used should be known. More information in this respect is given in chapter 4.2.5.2.

GROWTH RATE OF NAUPLII

Standard culture tests with brine shrimp from different geographical origin show important differences in growth rate even within the same sibling species, but not among batches of the same strain (Table 4.1 .3.). Although in the field the population growth of *Artemia* (*i.e.* after inoculation) is determined by lots of factors, selection of a strain with a high potential growth rate will have a positive impact on maximal production output.

TEMPERATURE AND SALINITY TOLERANCE

Both temperature and salinity significantly affect survival and growth, the effect of temperature being more pronounced. A broad range of temperatures and salinities meets the requirements for >90% survival. Strains from thalassohaline biotopes share a common temperature area of preference in the range 20-25°C where mortalities are <10 %. Interaction between temperature and salinity is limited; substantial differences in tolerance have been recorded at low salinities (around 5 g.l⁻¹) and high temperatures (30-34°C). At elevated temperatures the survival of the GSL strain is significantly higher than for other strains.

Table 4.1.3. Growth of *Artemia* nauplii from different cyst sources under standard culture conditions (7 days, darkness, 10 instar I nauplii/25 ml, 35 g.l⁻¹, 25°C, fed with *Dunaliella viridis*)

cyst source	growth expressed as % recorded for reference strain (SFB, batch 1)
San Francisco Bay, CA-USA, batch 1	96
San Francisco Bay, CA-USA, batch 2	96
Macau, Brazil, batch 1	98
Macau, Brazil, batch 2	103
Great Salt Lake, UT-USA, batch 1	125
Great Salt Lake, UT-USA, batch 2	127
Shark Bay, Australia	95
Chaplin Lake, Canada	130
Tanggu, Bohai Bay, PR China	110
Aibi Lake, PR China	105
Yuncheng, PR China	109

LIFE HISTORY TRAITS AND REPRODUCTIVE CAPACITY

Life history and reproductive characteristics of *Artemia* strains are important factors when an introduction of brine shrimp in a new habitat is considered, especially when competition with a local strain is to be expected. These competitive abilities are related to factors like the length of reproductive, pre- and post-reproductive period, total lifespan, number of offspring per brood, broods per female, time in-between broods *etc.* In general New World (bisexual) populations have a very large number of offspring per brood, a large number of offspring/day/female and a fast development time to sexual maturity, which favours this group to Old World bisexual and parthenogenetic *Artemia*.

Age at first reproduction is a key factor determining the population growth rate, and the rate of colonisation of new environments with limited nutrient resources. Consequently, if environmental preferences and nutritional factors don't interfere, New World bisexuals generally outcompete parthenogenetic strains, the latter in their turn predominating over Old World bisexuals. Inoculation experiments in natural habitats therefore require prior screening of candidate strains and of eventual local populations, as well as the study of prevailing environmental conditions. Uncontrolled introduction of *Artemia* may thus lead to a decrease of natural variability. Therefore, before inoculation of *Artemia* in a habitat with a local strain is undertaken, sufficient cyst material of the local population must be collected and stored in order to safeguard its gene-pool.

NUTRITIONAL VALUE

In the late seventies, when many fish and shrimp hatcheries started to go commercial, switching from one source of *Artemia* to another provoked unexpected problems (Table 4.1.4.). Very significant differences in production yields were even obtained with distinct *Artemia* batches of the same geographical origin. Especially the pattern of total lipids and fatty acid composition, as well as the metabolization of fatty acids in the *Artemia*, seemed to differ widely from strain to strain, and even from batch to batch, as a consequence of the fluctuations in biochemical composition of the primary producers (mainly unicellular algae) available to the adult population. Cyst products from inland resources are more constant in composition, be it however at suboptimal low levels. Appropriate techniques have thus been developed to improve the lipid profile of deficient *Artemia* strains, taking advantage of the indiscriminate filter-feeding behaviour of *Artemia*.

Applying simple methods lipophilic compounds can be easily incorporated into the *Artemia* before being offered as a prey (see chapter 4.4.).

A number of other compounds also appear to be variable from strain to strain: nutritional components such as total amount of free amino acids, pigments (canthaxanthin), vitamin C, minerals and trace elements, as well as contamination with chemicals such as pesticides and heavy metals. In most cases these variations are not strain specific, but just correspond to different production conditions. Despite this, their effects on larviculture success are usually far less significant.

Table 4.1.4. Growth and survival of fish and crustacean larvae fed with *Artemia* nauplii from different cyst sources

cyst source	species tested	survival	growth
San Francisco Bay, CA-USA, various batches	<i>Mysidopsis bahia</i>	+	+
	<i>Palaemon serratus</i>	+	+
	<i>Cyprinus carpio</i>	+	+
	<i>Solea solea</i>	+	+
	<i>Scophthalmus maximus</i>	+/-	+/-
	<i>Dicentrarchus labrax</i>	+	+
Macau, Brazil, various batches	<i>Mysidopsis bahia</i>	+	+
	<i>Cancer irroratus</i>	+	+
	<i>Menidia menidia</i>	+	±
	<i>Cyprinus carpio</i>	+	±
	<i>Scophthalmus maximus</i>	+	+
	<i>Pseudopleuronectes americanus</i>	+	±
Great Salt Lake, UT-USA, various batches	<i>Mysidopsis bahia</i>	+/-	+/-
	<i>Cancer irroratus</i>	-	-
	<i>Palaemon serratus</i>	-	-
	<i>Penaeus vannamei</i>	-	-
	<i>Menidia menidia</i>	+	+
	<i>Cyprinus carpio</i>	+	+
	<i>Dicentrarchus labrax</i>	-	-
Shark Bay, Australia	<i>Mysidopsis bahia</i>	+	+
	<i>Cancer irroratus</i>	+	+
	<i>Menidia menidia</i>	+	+
	<i>Cyprinus carpio</i>	+	+
	<i>Pseudopleuronectes americanus</i>	+	+
Chaplin Lake, Canada	<i>Mysidopsis bahia</i>	±	±
	<i>Menidia menidia</i>	±	-
	<i>Cyprinus carpio</i>	+	-
	<i>Pseudopleuronectes americanus</i>	+	±
Tianjin, Bohai Bay, PR China	<i>Pagrus major</i>	+	±
	<i>Mysidopsis bahia</i>	+	+
	<i>Menidia menidia</i>	+	+
	<i>Cyprinus carpio</i>	+	+
	<i>Pseudopleuronectes americanus</i>	+	+

4.1.3. Literature of interest

- Beardmore, J.A., Pilla, E.J., and Thomas, K.M. 1994. Genetic variation in *Artemia* : speciation, reproductive mode and potential for exploitation. In: Book of abstracts of contributions presented at the International Conference "Improvement of the commercial production of marine aquaculture species". G. Gajardo and P. Coutteau (Eds), Puerto Montt, Chile, 5-9 December 1994.
- Browne, R.A. and Bowen, S.T. 1991. Taxonomy and population genetics of *Artemia*. In: *Artemia* Biology. Browne, R.A., P. Sorgeloos and C.N.A. Trotman (Eds), CRC Press, Boca Raton Ann Arbor Boston, USA, pp 221 -235.
- Browne, R.A. and Halanych, K.M. 1989. Competition between sexual and parthenogenetic *Artemia*: a re-evaluation (Branchiopoda, Anostraca). *Crustaceana*, 57 (1) :57-71
- Browne, R.A., Li, M., Wanigasekera, G., Simonek, S., Brownlee, D., Eiband, G. and Cowan, J. 1993. Ecological, physiological and genetic divergence of sexual and asexual (diploid and polyploid) brine shrimp (*Artemia*). *Trends in Ecology*: 1-114.
- Browne, R.A., Sallee, S.E., Grosch, D.S., Segreti, W.O. and Purser, S.M. 1984. Partitioning genetic and environmental components of reproduction and lifespan in *Artemia*. *Ecology*, 65 (3): 949-960.
- Lavens, P. and Sorgeloos, P. 1987. The cryptobiotic state of *Artemia* cysts, its diapause deactivation and hatching, a review. In: *Artemia* Research and its Applications, Vol. 3. Sorgeloos, P., D.A. Bengtson, W. Decler and E. Jaspers (Eds), Universa Press, Wetteren, Belgium, pp 27 -63.
- Léger, Ph., Bengtson, D.A., Sorgeloos, P., Simpson, K.L. and Beck, A.D. 1987 . The nutritional value of *Artemia*, a review. In: *Artemia* Research and its Applications, Vol. 3. Sorgeloos, P., D.A. Bengtson, W. Decler and E. Jaspers (Eds), Universa Press, Wetteren, Belgium, pp 357 -37 2.
- Persoone, G. and Sorgeloos, P. 1980. . General aspects of the ecology and biogeography of *Artemia*. In: *The brine shrimp Artemia*. Vol. 3. Ecology, culturing, use in aquaculture. Persoone, G., P. Sorgeloos, O. Roels and E. Jaspers (Eds), Universa Press, Wetteren, Belgium, pp 3-24.
- Pilla, E.J.S and Beardmore, J.A. 1994. Genetic and morphometric differentiation in Old World bisexual species of the brine shrimp (*Artemia*). *Heredity*, 7 2: 47 -56.
- Tackaert, W. and Sorgeloos, P. 1991. Semi-intensive culturing in fertilized ponds. In: *Artemia* Biology. Browne, R.A, P. Sorgeloos and C.N.A. Trotman (Eds), CRC Press, Boca Raton Ann Arbor Boston, USA, pp 287-315.
- Triantaphyllidis, G.V., Zhang, B., Zhu, L. and Sorgeloos, P. 1994. International Study on *Artemia*. L. Review of the literature on *Artemia* from salt lakes in the People's Republic of China. *International Journal of Salt Lake Research*, 3:1-12.
- Vanhaecke, P., Tackaert, W. and Sorgeloos, P. 1987 . The biogeography of *Artemia*: an updated review. In: *Artemia* research and its applications. Vol. 1. Morphology, genetics, strain characterisation, toxicology. Sorgeloos, P., D.A. Bengtson, W. Decler and E. Jaspers (Eds), Universa Press, Wetteren, Belgium, pp 129-155

4.2. Use of cysts

Gilbert Van Stappen

Laboratory of Aquaculture & Artemia Reference Center
University of Gent, Belgium

4.2.1. Cyst biology

4.2.1.1. Cyst morphology

A schematic diagram of the ultrastructure of an *Artemia* cyst is given in Fig. 4.2.1.

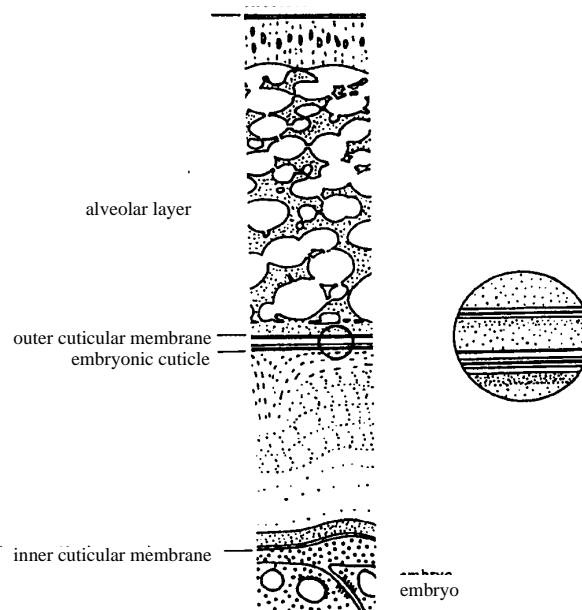

Figure 4.2.1. Schematic diagram of the ultrastructure of an *Artemia* cyst. (modified from Morris and Afzelius, 1967)

The cyst shell consists of three layers:

- alveolar layer: a hard layer consisting of lipoproteins impregnated with chitin and haematin; the haematin concentration determines the colour of the shell, *i.e.* from pale to dark brown. Its main function is to provide protection for the embryo against mechanical disruption and UV radiation. This layer can be completely removed (dissolved) by oxidation treatment with hypochlorite (= cyst decapsulation, see 4.2.3.).
- outer cuticular membrane: protects the embryo from penetration by molecules larger than the CO₂ molecule (= multilayer membrane with very special filter function; acts as a permeability barrier).
- embryonic cuticle: a transparent and highly elastic layer separated from the embryo by the inner cuticular membrane (develops into the hatching membrane during hatching incubation).

The embryo is an indifferentiated gastrula which is ametabolic at water levels below 10% and which can be stored for long periods without losing its viability. The viability is affected when cysts are stored at water levels higher than 10% (start of metabolic activity) and when cysts are exposed to oxygen; *i.e.* in the presence of oxygen cosmic radiation results in the formation of free radicals which destroy specific enzymatic systems in the ametabolic *Artemia* cysts.

4.2.1.2. Physiology of the hatching process

The development of an *Artemia* cyst from incubation in the hatching medium till nauplius release is shown in Fig. 4.2.2.

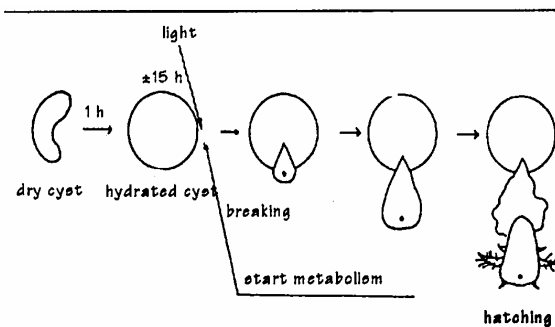

Figure 4.2.2. Development of an *Artemia* cyst from incubation in seawater until nauplius release.

When incubated in seawater the biconcave cyst swells up and becomes spherical within 1 to 2 h. After 1 2 to 20 h hydration, the cyst shell (including the outer cuticular membrane) bursts (= breaking stage) and the embryo surrounded by the hatching membrane becomes visible. The embryo then leaves the shell completely and hangs underneath the empty shell (the hatching membrane may still be attached to the shell). Through the transparent hatching membrane one can follow the differentiation of the pre-nauplius into the instar I nauplius which starts to move its appendages. Shortly thereafter the hatching membrane breaks open (= hatching) and the free-swimming larva (head first) is born.

Dry cysts are very hygroscopic and take up water at a fast rate (*i.e.* within the first hours the volume of the hydrated embryo increases to a maximum of 40% water content; Fig.4.2.3. However, the active metabolism starts from a 60% water content onwards, provided environmental conditions are favourable (see further).

The aerobic metabolism in the cyst embryo assures the conversion of the carbohydrate reserve trehalose into glycogen (as an energy source) and glycerol.

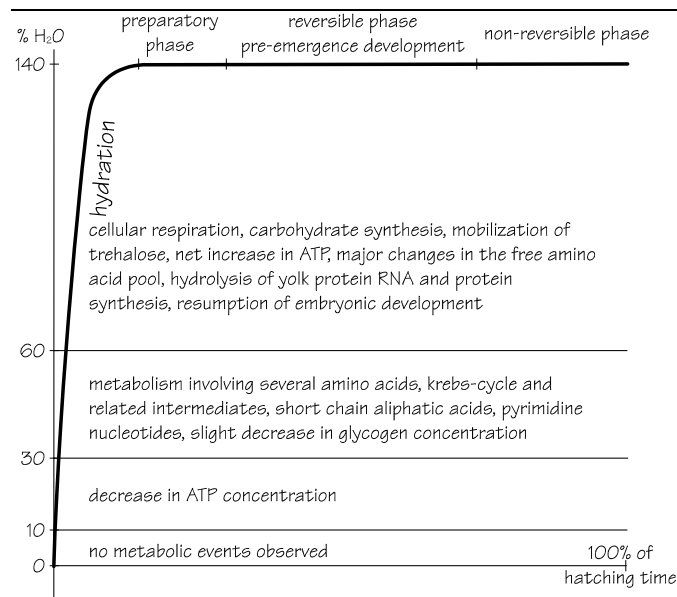

Figure 4.2.3. Cellular metabolism in *Artemia* cysts in function of hydration level.

Increased levels of the latter hygroscopic compound result in further water uptake by the embryo. Consequently, the osmotic pressure inside the outer cuticular membrane builds up continuously until a critical level is reached, which results in the breaking of the cyst envelope, at which moment all the glycerol produced is released in the hatching medium. In other words the metabolism in *Artemia* cysts prior to the breaking is a trehalose-glycerol hyperosmotic regulatory system. This means that as salinity levels in the incubation medium increase, higher concentrations of glycerol need to be built up in order to reach the critical difference in osmotic pressure which will result in the shell bursting, and less energy reserves will thus be left in the nauplius.

After breaking the embryo is in direct contact with the external medium through the hatching membrane. An efficient ionic osmoregulatory system is now in effect, which can cope with a big range of salinities, and the embryo differentiates into a moving nauplius larva. A hatching enzyme, secreted in the head region of the nauplius, weakens the hatching membrane and enables the nauplius to liberate itself into the hatching medium.

4.2.1.3. Effect of environmental conditions on cyst metabolism

Dry cysts (water content from 2 to 5 % ; see worksheet 4.2.1. for determination of water content and Table 4.2.6. for practical example) are very resistant to extreme temperatures; hatching viability not being affected in the temperature range -273C and above 60°C and up t 90°C only short exposures being tolerated.

Hydrated cysts have far more specific tolerances with mortalities occurring below -18°C and above +40°C; a reversible interruption of the metabolism (= viability not affected) occurring between -18°C and +4°C and between ± 33°C and ± 40°C, with the upper and lower temperature limits varying slightly from strain to strain. The active cyst metabolism is situated between +4°C and ± 33°C; the hatching percentage remains constant but the nauplii hatch earlier as the temperature is higher.

As for other environmental conditions, optimal hatching outputs are reached in the pH range 8-8.5. As a consequence, the addition of NaHCO_3 , up to 2 g.l^{-1} , to artificial or diluted seawater or to dense suspensions of cysts results in improved hatching. This might be related to the optimal pH activity range for the hatching enzyme.

An increased hatching has been reported with increasing oxygen level in the range 0.6 and 2 ppm, and maximal hatching obtained above this concentration. To avoid oxygen gradients during hatching it is obvious that a good homogeneous mixing of the cysts in the incubation medium is required.

As stated above, hatching in a higher salinity medium will consume more of the energy reserves of the embryo. Above a threshold salinity (varying from strain to strain, $\pm 90 \text{ g.l}^{-1}$ for most strains) insufficient quantities of water can be taken up to support the embryo's metabolism. Optimal salinity for hatching is equally strain-specific, but generally situated in the range $15\text{-}70 \text{ g.l}^{-1}$.

Although the physiological role of light during the hatching process is poorly understood, brine shrimp cysts, when hydrated and in aerobic conditions, need a minimal light triggering for the onset of the hatching process, related to light intensity and/or exposure time.

As a result of the metabolic characteristics of hydrated cysts, a number of recommendations can be formulated with regard to their use. When cysts (both decapsulated and non-decapsulated) are stored for a long time, some precautions have to be taken in order to maintain maximal energy content and hatchability. Hatchability of cysts is largely determined by the conditions and techniques applied for harvesting, cleaning, drying and storing of the cyst material. The impact of most of these processes can be related to effects of dehydration or combined dehydration/hydration. For diapausing cysts, these factors may also interfere with the diapause induction/termination process, but for quiescent cysts, uncontrolled dehydration and hydration result in a significant drop of the viability of the embryos.

Hatching quality in stored cysts is slowly decreasing when cysts contain water levels from 10 to 35 % H_2O . This process may however be retarded when the cysts are stored at freezing temperatures. The exact optimal water level within the cyst (around 5 %) is not known, although there are indications that a too severe dehydration (down to 1-2 %) results in a drop in viability.

Water levels in the range 30-65 % initiate metabolic activities, eventually reducing the energy contents down to levels insufficient to reach the state of emergence under optimal hatching conditions. A depletion of the energy reserves is furthermore attained when the cysts undergo subsequent dehydration/hydration cycles. Long-term storage of such material may result in a substantial decrease of the hatching outcome. Cysts exposed for too long a period to water levels exceeding 65 % will have completed their pre-emergence embryonic development; subsequent dehydration of these cysts will in the worst case result in the killing of the differentiated embryos.

Sufficiently dehydrated cysts only keep their viability when stored under vacuum or in nitrogen; the presence of oxygen results in a substantial depletion of the hatching output through the formation of highly detrimental free radicals. Even properly packed cysts should be preferentially kept at low temperatures. However, when frozen, the cysts should be acclimated for one week at room temperature before hatching.

4.2.1.4. Diapause

As *Artemia* is an inhabitant of biotopes characterized by unstable environmental conditions, its survival during periods of extreme conditions (i.e. desiccation, extreme temperatures, high salinities) is ensured by the production of dormant embryos. *Artemia* females can indeed easily switch from live nauplii production (ovoviviparity) to cyst formation (oviparity) as a fast response to fluctuating circumstances. Although the basic mechanisms involved in this switch are not yet fully understood, sudden fluctuations seem to trigger oviparity (oxygen stress, salinity changes...). The triggering mechanism for the induction of the state of diapause is however not yet known. In principle, *Artemia* embryos released as cysts in the medium are in diapause and will not resume their development, even under favourable conditions, until they undergo some diapause deactivating environmental process; at this stage, the metabolic standstill is regulated by internal mechanisms and it can not be distinguished from a non-living embryo. Upon the interruption of diapause, cysts enter the stage of quiescence, meaning that metabolic activity can be resumed at the moment they are brought in favourable hatching conditions, eventually resulting in hatching: in this phase the metabolic arrest is uniquely dependent of external factors (Fig. 4.2.4.). As a result, synchronous hatching occurs, resulting in a fast start and consequent development of the population shortly after the re-establishment of favourable environmental conditions. This allows effective colonization in temporal biotopes.

For the user of *Artemia* cysts several techniques have proven successful in terminating diapause. It is important to note here that the sensitivity of *Artemia* cysts to these techniques shows strain- or even batch-specificity, hence the difficulty to predict the effect on hatching outcome. When working with new or relatively unknown strains, the relative success or failure of certain methods has to be found out empirically.

In many cases the removal of cyst water is an efficient way to terminate the state of diapause. This can be achieved by drying the cysts at temperatures not exceeding 35-4°C or by suspending the cysts in a saturated NaCl brine solution (300 g.l⁻¹). As some form of dehydration is part of most processing and/or storage procedures, diapause termination does not require any particular extra manipulation. Nevertheless, with some strains of *Artemia* cysts the usual cyst processing techniques does not yield a sufficiently high hatching quality, indicating that a more specific diapause deactivation method is necessary.

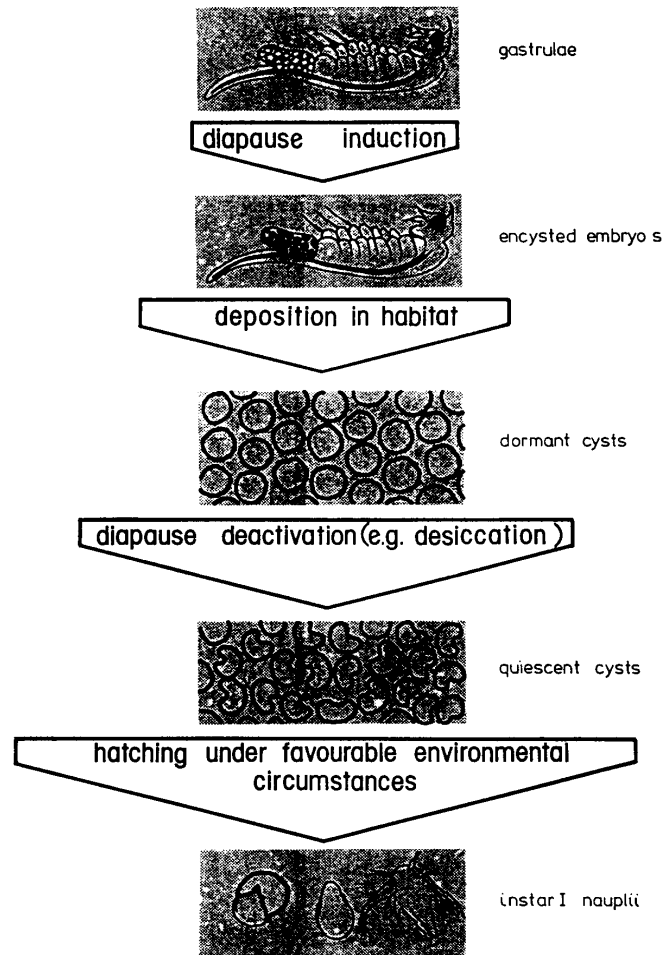

Figure 4.2.4. Schematic diagram explaining the specific terminology used in relation with dormancy of *Artemia* embryos.

Table 4.2.1. Effect of cold storage at different temperatures on the hatchability of shelf dried *Artemia* cysts from Kazakhstan

storage time	storage temperature		
	+4°C	-25°C	-80°C
0 days	7	7	7
2 weeks	-	-	4
1 month	7	16	12
2 months	27	44	50

Hatchability is expressed as hatching percentage

The following procedures have proven to be successful when applied with specific sources of *Artemia* cysts (see worksheet 4.2.2.):

- freezing: "imitates" the natural hibernation period of cysts originating from continental biotopes with low winter temperatures (Great Salt Lake, Utah, USA; continental Asia; Table 4.2.1.);
- incubation in a hydrogen peroxide (H₂O₂) solution. In most cases, the sensitivity of the strain (or batch) to this product is difficult to predict, and preliminary tests are needed to provide information about the optimal dose/period to be applied, and about the maximal effect that can be obtained (Table 4.2.2.). Overdosing results in reduced hatching or even complete mortality as a result of the toxicity of the chemical. However, in some cases no effect at all is observed.

In general other diapause termination techniques (cyclic dehydration/hydration, decapsulation, other chemicals...) give rather erratic results and/or are not user-friendly. One should, however, keep in mind that the increase in hatching percentage after any procedure might (even partially) be the result of a shift in hatching rate (earlier hatching).

Table 4.2.2. Dose-time effect of H₂O₂ preincubation treatment on the hatchability of *Artemia* cysts from Vung Tau (Viet Nam)

Time (min.)	Doses(%)					
	0.5	1	2	3	5	10
1					46	10
2					94	5
5			54	69	102	
10	47		90	81	88	32
15		46	100	76		
20			91	94	52	
30		91	95			
60	56	85		6	1	
120		15				
180	47					

Data are expressed as percentage of hatching results obtained at 2%/15 min. treatment (74% hatch)

4.2.2. Disinfection procedures

A major problem in the early rearing of marine fish and shrimp is the susceptibility of the larvae to microbial infections. It is believed that the live food can be an important source of potentially pathogenic bacteria, which are easily transferred through the food chain to the predator larvae. *Vibrio sp.* constitute the main bacterial flora in *Artemia* cyst hatching solutions. Most *Vibrio* are opportunistic bacteria which can cause disease/mortality outbreaks in larval rearing, especially when fish are stressed or not reared under optimal conditions. As shown on Fig. 4.2.5., *Artemia* cyst shells may be loaded with bacteria, fungi, and even contaminated with organic impurities;

bacterial contamination in the hatching medium can reach numbers of more than 10^7 CFU.ml⁻¹ (= colony forming units). At high cyst densities and high incubation temperatures during hatching, bacterial development (e.g. on the released glycerol) can be considerable and hatching solutions may become turbid, which may also result in reduced hatching yields. Therefore, if no commercially disinfected cysts are used, it is recommended to apply routinely a disinfection procedure by using hypochlorite (see worksheet 4.2.3.). This treatment, however, may not kill all germs present in the alveolar and cortical layer of the outer shell. Complete sterilization can be achieved through cyst decapsulation, described in the following chapter.

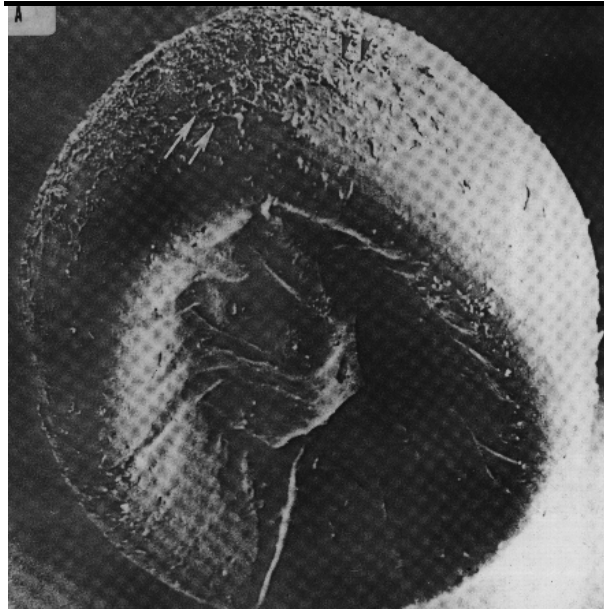

Figure 4.2.5. Scanning electron microphotograph of dehydrated *Artemia* cyst.

4.2.3. Decapsulation

The hard shell that encysts the dormant *Artemia* embryo can be completely removed by short-term exposure to a hypochlorite solution. This procedure is called decapsulation. Decapsulated cysts offer a number of advantages compared to the non-decapsulated ones:

- Cyst shells are not introduced into the culture tanks. When hatching normal cysts, the complete separation of *Artemia* nauplii from their shells is not always possible. Unhatched cysts and empty shells can cause deleterious effects in the larval tanks when they are ingested by the predator: they can not be digested and may obstruct the gut.
- Nauplii that are hatched out of decapsulated cysts have a higher energy content and individual weight (30-55 % depending on strain) than regular instar I nauplii, because they do not spend energy necessary to break out of the shell (Fig. 4.3.4.). In some cases where cysts have a relatively low energy content, the hatchability might be improved by decapsulation, because of the lower energy requirement to break out of a decapsulated cyst (Table 4.2.3.).
- Decapsulation results in a disinfection of the cyst material (see 4.2.2.).
- Decapsulated cysts can be used as a direct energy-rich food source for fish and shrimp (see 4.2.4.).
- For decapsulated cysts, illumination requirements for hatching would be lower.

Table 4.2.3. Improved hatching characteristics (in percent change) of *Artemia* cysts as a result of decapsulation

cyst source	hatchability	naupliar dry weight	hatching output
San Francisco Bay, CA-USA	+ 15	+ 7	+ 23
Macau, Brazil	+ 12	+ 2	+ 14
Great Salt Lake, UT-USA	+ 24	- 2	+ 21
Shark Bay, Australia	+ 4	+ 6	+ 10
Chaplin Lake, Canada	+ 132	+ 5	+ 144
Bohai Bay, PR China	+ 4	+ 6	+ 10

The decapsulation procedure involves the hydration of the cysts (as complete removal of the envelope can only be performed when the cysts are spherical), removal of the brown shell in a hypochlorite solution, and washing and deactivation of the remaining hypochlorite (see worksheets 4.2.4. and 4.2.5.). These decapsulated cysts can be directly hatched into nauplii, or dehydrated in saturated brine and stored for later hatching or for direct feeding. They can be stored for a few days in the refrigerator at 0-4°C without a decrease in hatching. If storage for prolonged periods is needed (weeks or few months), the decapsulated cysts can be transferred into a saturated brine solution. During overnight dehydration (with aeration to maintain a homogeneous suspension) cysts usually release over 80 % of their cellular water, and upon interruption of the aeration, the now coffee-bean shaped decapsulated cysts settle out. After harvesting of these cysts on a mesh screen they should be stored cooled in fresh brine. Moreover, since they lose their hatchability when exposed to UV light it is advised to store them protected from direct sunlight.

4.2.4. Direct use of decapsulated cysts

The direct use of *Artemia* cysts, in its decapsulated form, is much more limited in larviculture of fish and shrimp, compared to the use of *Artemia* nauplii. Nevertheless, dried decapsulated *Artemia* cysts have proven to be an appropriate feed for larval rearing of various species like the freshwater catfish (*Clarias gariepinus*) and carp (*Cyprinus carpio*), marine shrimp and milkfish larvae. Currently, commercially produced decapsulated cysts are frequently used in Thai shrimp hatcheries from the PL4 stage onwards. The use of decapsulated cysts in larval rearing presents some distinct advantages, both from a practical and nutritional point of view.

The daily production of nauplii is labour intensive and requires additional facilities. Furthermore, *Artemia* cysts of a high hatching quality are often expensive, and decapsulation of non-hatching cysts means valorization of an otherwise inferior product. The cysts have the appearance and the practical advantages of a dry feed and, in contrast to *Artemia* nauplii (470-550 µm), their small particle size (200-250 µm) is more suitable for small predator stages. If they have been dried before application, they have a high floating capacity, and sink only slowly to the bottom of the culture tank. Leaching of nutritional components (for example, with artificial diets) does not occur, since the outer cuticular membrane acts as a barrier for larger molecules).

On the other hand, a possible major drawback of decapsulated cysts is their immobility, and thus low visual attractivity for the predator. Moreover, decapsulated cysts dehydrated in brine sink rapidly to the bottom, thus reducing their availability for fish larvae feeding in the water column. Extra aeration or drying is therefore needed to keep these particles better in suspension. However, on the contrary, older penaeid larvae are mainly bottom feeders and so do not encounter this problem.

From the nutritional point of view, the gross chemical composition of decapsulated cysts is comparable to freshly-hatched nauplii (Table 4.2.4.). In addition, their individual dry weight and energy content is on the average 30 to 40 % higher than for instar I nauplii (see 4.2.3.; Fig. 4.3.4.). For example, for the culture of carp larvae during the first two weeks, the use of decapsulated cysts constitutes a saving of over one third in the amount of *Artemia* cysts used, compared to the use of live nauplii.

	GSL		SFB	
	cysts	nauplii	cysts	nauplii
protein	± 50	41-47	± 57	47-59
lipid	± 14	21-23	± 13	16-27
carbohydrate	-	11	-	11
ash	± 9	10	± 5	6-14

Furthermore, some differences are found for specific nutrients/components which may have an effect on their nutritional quality.

- **Fatty acids:** the fatty acid spectrum of cysts and nauplii is nearly identical, although differences can be found in lipid levels, FAME levels, fatty acid composition and energy content of different strains.
- **Free amino acids:** the ratio of free amino acids (FAA) to protein content is generally higher for instar I nauplii, compared to cysts, although large variations may exist from strain to strain. This may have dietary consequences when decapsulated cysts are used, since marine fish larvae use their large pool of free amino acids as an energy substrate during the first days after hatching.
- **Vitamin C** (ascorbic acid) is considered as an essential nutrient during larviculture. It is found as ascorbic acid 2-sulfate (AAS) in cysts of brine shrimp, a very stable form but with low bio-availability. During the hatching process the AAS is hydrolyzed into free ascorbic acid, a more unstable form, but directly available in the nauplii for the predator. Decapsulation of cysts does not lead to ascorbic sulfate hydrolysis. Resorption and biological activity of AAS in the predator's tissue is still subject of research, and although several freshwater fish have been grown successfully with decapsulated cysts in the larval phase (see above), one can state that feeding decapsulated cysts to larval fish for a prolonged time might lead to vitamin C deficiency in the case that the predator is lacking the sulfatase enzyme needed to break down AAS.

- **Carotenoids:** the carotenoid pattern, and more specifically the canthaxanthin contents, show qualitative differences between cysts and nauplii. In *Artemia* cysts the unusual cis-configuration is found, whereas in developing nauplii it is converted into the more stable trans-canthaxanthin.

4.2.5. Hatching

4.2.5.1. Hatching conditions and equipment

Although hatching of small quantities of *Artemia* cysts is basically very simple, several parameters need to be taken into consideration for the successful hatching of large (i.e. kilogram) quantities of cysts, which is a common daily practice within large hatcheries:

- aeration
- temperature
- salinity
- pH
- cyst density
- illumination

For routine operation, it is most efficient to work in standardized conditions (i.e. heaters with thermostat or climatized room to ensure constant temperature, fixed cyst density) to allow maximal production of a homogeneous instar I population after a fixed incubation time (see worksheet 4.2.6.).

Best hatching results are achieved in containers with a conical bottom, aerated from the bottom with air-lines (Fig. 4.3.1.). Cylindrical or square-bottomed tanks will have dead spots in which *Artemia* cysts and nauplii accumulate and suffer from oxygen depletion. Transparent or translucent containers will facilitate inspection of the hatching suspension, especially when harvesting.

As a consequence of specific characteristics, the interactions of the hatching parameters might be slightly different from strain to strain, resulting in variable hatching results. The aeration intensity must be sufficient to maintain oxygen levels above 2 mg.l⁻¹, preferentially 5 mg.l⁻¹. The optimal aeration rate is a function of the tank size and the density of cysts incubated. Excessive foaming can be reduced by disinfection of the cysts prior to hatching incubation and/or by the addition of a few drops of a non-toxic antifoaming agent (e.g. silicone antifoam).

The temperature of the seawater is preferentially kept in the range of 25-28°C; below 25°C cysts hatch more slowly and above 33°C the cyst metabolism is irreversibly stopped. However, the effect of more extreme temperatures on the hatching output is largely strain specific.

The quantitative effects of the incubation salinity on cyst hatching are in the first place related with the hydration level that can be reached in the cysts. Above a threshold salinity, insufficient quantities of water can be taken up by the cysts; this threshold value varies from strain to strain, but is approximately 85-90 g.l⁻¹ for most *Artemia* strains. In the second place,

the incubation salinity will interfere with the amount of glycerol that needs to be built up to reach the critical osmotic pressure within the outer cuticular membrane of the cysts. The fastest hatching rates will thus be noted at the lowest salinity levels since it will take less time to reach breaking point. Optimal hatching can be obtained in the range 5-35 g.l⁻¹. For reasons of practical convenience natural seawater is mostly used to hatch cysts. However, at 5 g.l⁻¹ salinity, the nauplii hatch faster, as less glycerol has to be built up. For some sources of cysts hatching the cysts at low salinity results in higher hatching efficiencies, and the nauplii have a higher energy content (Table 4.2.5). The salinity can easily be measured by means of a refractometer or densitometer. Conversion tables for various units of measurement are given in Tables 4.2.9. and 4.2.10.

The pH must remain above 8 during the hatching process so as to ensure optimal functioning of the hatching enzyme. If needed, (i.e. when low salinity water is used), the buffer capacity of the water should be increased by adding up to 1 g NaHCO₃.l⁻¹. Increased buffer capacities can also become essential when high densities of cysts are hatched (= high CO₂ production).

Cyst density may also interfere with the other abiotic factors that are essential for hatching, such as pH, oxygen, and illumination. The density may be as high as 5 g.l⁻¹ for small volumes (<20 l) but should be decreased to maximum 2 g.l⁻¹ for larger volumes, so as to minimize the mechanical injury of the nauplii and to avoid suboptimal water conditions.

Strong illumination (about 2000 lux at the water surface) is essential, at least during the first hours after complete hydration, in order to trigger/start embryonic development. Although this level of illumination is mostly attained during daytime in transparent tanks that are set up outdoors in the shade, it is advisory to keep the hatching tanks indoors and to provide artificial illumination so as to ensure good standardisation of the hatching process.

4.2.5.2. Hatching quality and evaluation

An acceptable cyst product should contain minimal quantities of impurities, such as sand, cracked shells, feathers, and salt crystals, *etc.* Hatching synchrony must be high; when incubated in 33 g.l⁻¹ seawater at 25°C, the first nauplii should appear after 12 to 16 h incubation (T₀; see further) and the last nauplii should have hatched within 8 h thereafter (T₁₀₀). When hatching synchrony is low (T₁₀₀-T₀ > 10 h), first-hatched nauplii will have consumed much of their energy reserves by the time that the last nauplii will have hatched and harvesting is completed. Moreover, since the total incubation period exceeds 24 h the aquaculturist will not be able to restock the same hatching containers for the next day's harvest, which in turn implies higher infrastructural costs. The hatching efficiency (the number of nauplii hatched per gram of cysts) and hatching percentage (the total percentage of the cysts that actually hatch) often varies considerably between different commercial batches and obviously account for much of the price differences. In this respect, hatching efficiency may be a better criterion than hatching percentage as it also takes into account the content of impurities (*i.e.* empty cyst shells). Hatching values may be as low as 100,000 nauplii.g⁻¹ of commercial cyst product, while premium quality cysts from Great Salt Lake yield 270,000 nauplii per gram of cysts (with an equivalent hatching percentage of >90 %); batches of small (=lighter) cysts (*e.g.* SFB type) may yield even higher numbers of nauplii, (*i.e.* 320,000 nauplii/g cysts).

To evaluate the hatching quality of a cyst product, the following criteria are being used (see worksheet 4.2.7., for practical examples, see Tables 4.2.7 and 4.2.8):

- hatching percentage:
 - = number of nauplii that can be produced under standard hatching conditions from 100 full cysts; this criterion does not take into account cyst impurities, (*i.e.* cracked shells, sand, salt, *etc.*), and refers only to the hatching capacity of the full cysts, which in turn depends upon:
 - a) degree of diapause termination: cysts that are still in diapause do not hatch, even under favourable hatching conditions
 - b) energy content of cysts: may be too low to build up sufficient levels of glycerol to enable breaking and hatching, as a consequence of, for example, improper processing and/or storage (see 4.2.1.3.), environmental or genotypical conditions affecting parental generation...
 - c) amount of dead/non-viable/abortic embryos, due to improper processing and/or storage.

- hatching efficiency:
 - = number of nauplii that can be produced from 1 g dry cyst product under standard hatching conditions. This criterion reflects:
 - a) the hatching percentage (see above)
 - b) the presence of other components apart from full cysts in the cyst product (*i.e.* empty shells, salt, sand, water content of the cysts)
 - c) the individual cyst weight (*i.e.* more cysts/g for smaller strains)

As this criterion can refer to the ready-to-use commercial product, it has very practical implications, since the price of the product can be directly related to its output.

- hatching rate:

this criterion refers to the time period for full hatching from the start of incubation (= hydration of cysts) until nauplius release (hatching), and considers a number of time intervals, including:

 - T_0 = incubation time until appearance of first free-swimming nauplii
 - T_{10} = incubation time until appearance of 10 % of total hatchable nauplii, *etc.* (Fig. 4.2.6.).

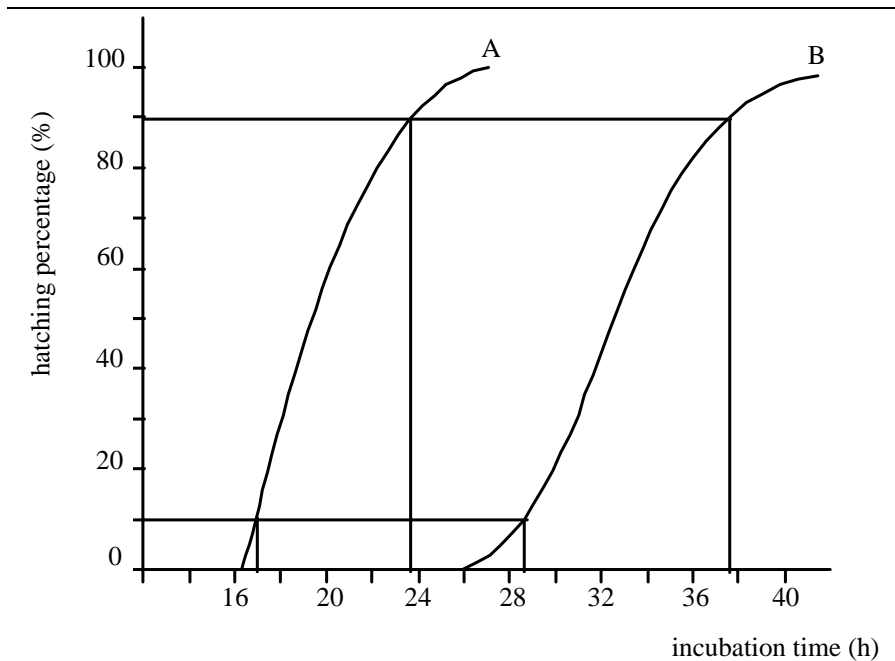

Figure 4.2.6. Hatching rate curves from different cyst batches. Curve A: T_{10} = 17 h, T_{90} = 23.5 h, T_s = 6.5 h; Curve B: T_{10} = 28.5 h, T_{90} = 37.5 h, T_s = 9 h.

Data on the hatching rate allow the calculation of the optimal incubation period so as to harvest nauplii containing the highest energy content (Fig. 4.3.4.). It is important that the T_{90} is reached within 24 h; if not more hatching tanks will be needed so as to ensure a daily supply of a maximal number of instar I nauplii.

- hatching synchrony:

= time lapse during which most nauplii hatch, *i.e.* $T_s = T_{90} - T_{10}$

A high hatching synchrony ensures a maximal number of instar I nauplii available within a short time span; in case of poor synchrony the same hatching tank needs to be harvested several times in order to avoid a mixed instar I-II-III population when harvesting at T_{90} .

- hatching output:

= dry weight biomass of nauplii that can be produced from 1 gram dry cyst product incubated under standard hatching conditions; best products yield about 600 mg nauplii.g⁻¹ cysts. The calculation is made as follows:

= hatching efficiency x individual dry weight of instar I nauplius.

The hatching efficiency only accounts for the number of nauplii that are produced, and not for the size of these nauplii (strain dependent); by contrast the hatching output criterion is related to the total amount of food available for the predator per gram of cyst product (*cf.* calculation of food conversion).

Table 4.2.5. Effect of incubation at low salinity on hatching percentage, individual nauplius weight, and hatching output for *Artemia* cyst sources from different geographical origin

cyst source	hatching percentage (%)		
	35 g.l ⁻¹	5 g.l ⁻¹	% diff.
San Francisco Bay, CA-USA	71.4	68.0	-4.8
Macau, Brazil	82.0	86.4	+5.3
Great Salt Lake, UT-USA	43.9	45.3	+3.1
Shark Bay, Australia	87.5	85.8	-1.9
Chaplin Lake, Canada	19.5	52.2	+167.6
Bohai Bay, PR China	73.5	75.0	+2.0
	naupliar dry weight (µg)		
San Francisco Bay, CA-USA	1.63	1.73	+6.1
Macau, Brazil	1.74	1.76	+1.1
Great Salt Lake, UT-USA	2.42	2.35	-2.5
Shark Bay, Australia	2.47	2.64	+6.9
Chaplin Lake, Canada	2.04	2.28	+11.8
Bohai Bay, PR China	3.09	3.07	-0.6
	hatching output (mg nauplii.g ⁻¹ cysts)		
San Francisco Bay, CA-USA	435.5	440.2	+1.1
Macau, Brazil	529.0	563.7	+6.6
Great Salt Lake, UT-USA	256.5	257.0	+0.2
Shark Bay, Australia	537.5	563.3	+4.8
Chaplin Lake, Canada	133.8	400.4	+199.3
Bohai Bay, PR China	400.5	406.0	+1.4

4.2.6. Literature of interest

- Browne, R.A., Sorgeloos, P. and Trotman, C.N.A. (Eds). 1991. *Artemia* Biology. Boston, USA, CRC Press, 374 pp.
- Bruggeman, E., Sorgeloos, P. and Vanhaecke, P. 1980. Improvements in the decapsulation technique of *Artemia* cysts. In: The brine shrimp *Artemia*. Vol. 3. Ecology, culturing and use in aquaculture. Persoone, G., P. Sorgeloos, O. Roels and E. Jaspers (Eds), Universa Press, Wetteren, Belgium, pp 261-269.
- Clegg, J.S. and Conte, F.P. 1980. A review of the cellular and developmental biology of *Artemia*. In: The brine shrimp *Artemia*. Vol. 2. Physiology, biochemistry, molecular biology. Persoone, G., P. Sorgeloos, O. Roels and E. Jaspers (Eds), Universa Press, Wetteren, Belgium, pp 11-54.
- Lavens, P. and Sorgeloos, P. 1987. The cryptobiotic state of *Artemia* cysts, its diapause deactivation and hatching, a review. In: *Artemia* Research and its Applications, Vol. 3. Sorgeloos, P., D.A. Bengtson, W. Declerck and E. Jaspers (Eds), Universa Press, Wetteren, Belgium, pp 27-63.
- MacRae, T.H., Bagshaw, J.C. and Warner, A.H. (Eds). 1989. Biochemistry and cell biology of *Artemia*. Boca Raton, Florida, USA, CRC press, 264 pp.
- Morris, J.C. and Afzelius, B.A. 1967. The structure of the shell and outer membranes in encysted *Artemia salina* embryos during cryptobiosis and development. *Journal of Ultrastructure Research* 20: 244-259.
- Verreth, J., Storch, V. and Segner, H. 1987. A comparative study on the nutritional quality of decapsulated *Artemia* cysts, micro-encapsulated egg diets and enriched dry feeds for *Clarias gariepinus* (Burchell) larvae. *Aquaculture*, 63: 269-282.
- Warner, A.H., MacRae, T.H. and Bagshaw J.C. (Eds). 1989. Cell and molecular biology of *Artemia* development. New York, USA, Plenum Press, 453 pp.

4.2.7. Worksheets

WORKSHEET 4.2.1. PROCEDURE FOR ESTIMATING WATER CONTENT OF ARTEMIA CYSTS.

- Take three small aluminium foil-cups = T_1, T_2, T_3 .
- Fill each cup with a cyst sample of approximately 500 mg.
- Determine gross weight (at 0.1 mg accuracy) = G_1, G_2, G_3 .
- Place aluminium cups containing cysts for 24°C in a drying oven at 60°C
- Determine gross waterfree weight (at 0.1 mg accuracy) = G_1', G_2', G_3' .
- Calculate water content W_i (in % H_2O)

$$W_i = (G_i - G_i') \cdot (G_i - T_i)^{-1} \cdot 100$$
- Calculate mean value for the three replicate samples.

Table 4.2.6. Practical example of the procedure for estimating the water content of *Artemia* cysts.

Sample	Weight of cup (in g) (=T _i)	Weight of cup + cyst sample (in g) (=G _i)	Weight of cup + dried cysts (in g) (=G _i ')	% water content (=W _i)
1	0.2158	0.7158	0.6688	9.4
2	0.2434	0.7434	0.6969	9.3
3	0.2827	0.7827	0.7365	9.2
mean water content				9.3

WORKSHEET 4.2.2. SPECIFIC DIAPAUSE TERMINATION TECHNIQUES

- freezing or cold storage:
 - * best results are obtained when using dehydrated (e.g. incubated in saturated brine) cysts;
 - * duration and temperature of the cold period depends on strain and even on batch; in most cases an incubation at $\pm -20^{\circ}\text{C}$ for 4-6 weeks will be the minimum requirement. Incubation in refrigerator ($+4^{\circ}\text{C}$) might produce suboptimal results, even after prolonged storage periods (months) (Table 4.2.1.);
 - * after hibernation, cysts should be acclimated at room temperature for a minimum 1 week before drying or hatching.
- treatment with hydrogen peroxide (H_2O_2):

Precautions:

- * generally the effect is most pronounced when applied on fully hydrated cysts (upon 1-2 h hydration in seawater). Exposure of cysts that have been incubated for a longer time will mostly have a toxic effect;
- * pure hydrogen peroxide readily dissociates in oxygen and water, especially at higher temperatures and when agitated; only a fresh or stabilized product should be used;
- * commonly a positive effect will be obtained by incubating the hydrated cysts in a 5 % solution for 5 min.; if the effect is below expectation, the dose should be modified (raised or lowered) by altering the concentration and/or the incubation time; solutions in the range 1 to 10 % and incubation times in the range 1 to 30 min. have proven to be successful at varying degrees (Table 4.2.2.);

Procedure:

- * hydrate cysts in tap- or seawater for 1-2 h at room temperature, (i.e. in a hatching cone) use aeration;
- * prepare peroxide solution (i.e. 5 %) in tapwater, using a fresh or stabilized concentrated product with known concentration;
- * suspend the hydrated cysts in this solution at a density of maximally 10-20 g cysts.l⁻¹; use of a cylindroconical container with aeration from the bottom ensures a homogeneous suspension (*cf.* hatching container); leave cysts in peroxide solution for fixed time period (i.e. 5 min.);
- * after time lapse, harvest cysts on 125 µm mesh size and rinse thoroughly with tapwater to remove all peroxide traces;
- * incubate cysts for hatching; in case the same container is used for this purpose, rinse very well.

WORKSHEET 4.2.3. DISINFECTION OF ARTEMIA CYSTS WITH LIQUID BLEACH.

- Prepare 200 ppm hypochlorite solution: ± 20 ml liquid bleach (NaOCl) (see decapsulation).10 l⁻¹;
- Soak cysts for 30 min. at a density of ± 50 g cysts.l⁻¹;
- Wash cysts thoroughly with tapwater on a 125 µm screen;
- Cysts are ready for hatching incubation.

WORKSHEET 4.2.4. PROCEDURES FOR THE DECAPSULATION OF *ARTEMIA* CYSTS.**HYDRATION STEP**

- Hydrate cysts by placing them for 1 h in water ($\leq 100 \text{ g.l}^{-1}$), with aeration, at 25°C.

DECAPSULATION STEP

- Collect cysts on a 125 μm mesh sieve, rinse, and transfer to the hypochlorite solution.
- The hypochlorite solution can be made up (in advance) of either liquid bleach NaOCl (fresh product; activity normally =11-13 % w/w) or bleaching powder $\text{Ca}(\text{OCl})_2$ (activity normally ± 70 %) in the following proportions:
 - * 0.5 g active hypochlorite product (activity normally labeled on the package, otherwise to be determined by titration) per g of cysts; for procedure see further);
 - * an alkaline product to keep the $\text{pH} > 10$; per g of cysts use:
 - ◆ 0.15 g technical grade NaOH when using liquid bleach;
 - ◆ either 0.67 NaCO_3 or 0.4 g CaO for bleaching powder; dissolve the bleaching powder before adding the alkaline product; use only the supernatants of this solution;
 - ◆ seawater to make up the final solution to 14 ml per g of cysts.
- Cool the solution to 15-20°C (i.e. by placing the decapsulation container in a bath filled with ice water). Add the hydrated cysts and keep them in suspension (i.e. with an aeration tube) for 5-15 min. Check the temperature regularly, since the reaction is exothermic; never exceed 40°C (if needed add ice to decapsulation solution). Check evolution of decapsulation process regularly under binocular.

WASHING STEP

- When cysts turn grey (with powder bleach) or orange (with liquid bleach), or when microscopic examination shows almost complete dissolution of the cyst shell (= after 3-15 min.), cysts should be removed from the decapsulation suspension and rinsed with water on a 125 μm screen until no chlorine smell is detected anymore. It is crucial not to leave the embryos in the decapsulation solution longer than strictly necessary, since this will affect their viability.

DEACTIVATION STEP

- Deactivate all traces of hypochlorite by dipping the cysts (< 1 min.) either in 0.1 N HCl or in 0.1 % $\text{Na}_2\text{S}_2\text{O}_3$ solution, then rinse again with water. Hypochlorite residues can be detected by putting some decapsulated cysts in a small amount of starch-iodine indicator (= starch, KI, H_2SO_4 and water). When the reagent turns blue, washing and deactivation has to be continued.

USE

- Incubate the cysts for hatching, or store in the refrigerator (0-4°C) for a few days before hatching incubation. For long term storage cysts need to be dehydrated in saturated brine solution (1 g of dry cysts per 10 ml of brine of 300 g $\text{NaCl}\cdot\text{l}^{-1}$). The brine has to be renewed after 24 h.

WORKSHEET 4.2.5. TITRIMETRIC METHOD FOR THE DETERMINATION OF ACTIVE CHLORINE IN HYPOCHLORITE SOLUTIONS

- Principle : active chlorine will liberate free iodine from KI solution at pH 8 or less. The liberated iodine is titrated with a standard solution using $\text{Na}_2\text{S}_2\text{O}_3$, with starch as the indicator.
- Reagents:
 - * acetic acid (glacial, concentrated)
 - * KI crystals
 - * $\text{Na}_2\text{S}_2\text{O}_3$, 0.1 N standard solution
 - * starch indicator solution: mix 5 g starch with a little cold water and grind in a mortar. Pour into 1 l of boiling distilled water, stir, and let settle overnight. Use the clear supernatants. Preserve with 1.25 g salicylic acid.
- Procedure:
 - * dissolve 0.5 to 1 g KI in 50 ml distilled water, add 5 ml acetic acid, or enough to reduce the pH to between 3.0 and 4.0;
 - * add 1 ml sample;
 - * titrate protected from direct sunlight. Add 0.1 N $\text{Na}_2\text{S}_2\text{O}_3$ from a buret until the yellow colour of the liberated iodine is almost disappearing. Add 1 ml starch solution and titrate until the blue colour disappears.
- Calculation:
 - * 1 ml 0.1 N $\text{Na}_2\text{S}_2\text{O}_3$ equals 3.54 mg active chlorine.

WORKSHEET 4.2.6. *ARTEMIA* HATCHING

- use a transparent or translucent cylindroconical tank
- supply air through open aeration line down to the tip of the conical part of the tank; oxygen level should be maintained above 2 g.l⁻¹, apply strong aeration
- a valve at the tip of the tank will facilitate harvesting
- use preheated, filtered (i.e. with a filter bag) natural seawater (\pm 33 g.l⁻¹)
- hatching temperature: 25-28°C
- pH should be 8-8.5; if necessary add dissolved sodium bicarbonate or carbonate (up to 2 g.l⁻¹ technical grade NaHCO₃)
- apply minimum illumination of 2000 lux at the water surface, (i.e. by means of fluorescent light tubes positioned close to the water surface)
- disinfect cysts prior to hatching incubation (see 4.2.2.)
- incubate cysts at density of 2 g.l⁻¹; for smaller volumes (<20 l) a maximal cyst density of 5 g.l⁻¹ can be applied. Required amount of cysts depends on hatching efficiency of cyst batch (number of nauplii per gram, see further) and required amount of nauplii
- incubate for fixed time period (e.g. 20 hr)
- harvesting: see 4.3.1.

WORKSHEET 4.2.7. DETERMINATION OF HATCHING PERCENTAGE,
HATCHING EFFICIENCY AND HATCHING RATE

- Incubate exactly 1.6 g of cysts in exactly 800 ml 33 g.l⁻¹ seawater under continuous illumination (2000 lux) at 28°C in a cyllindroconical tube (preferentially) or in a graduated cylinder; provide aeration from bottom as to keep all cysts in suspension (aeration not too strong as to prevent foaming); run test in triplicate.
- After 24 h incubation take 6 subsamples of 250 µl out of each cone.
- Pipet each subsample into a small vial and fixate nauplii by adding a few drops of lugol solution.
- Per cone (i = 6 subsamples), count nauplii (n_i) under a dissection microscope and calculate the mean value (N), count umbrellas (u_i) and calculate mean value (U).
- Decapsulate unhatched cysts and dissolve empty cyst shells by adding one drop of NaOH solution (40 g.100 ml⁻¹ distilled water) and 5 drops of domestic bleach solution (5.25% NaOCl) to each vial.
- Per cone (i = 6), count unhatched (orange colored) embryos (e_i) and calculate mean value (E).
- Hatching percentage $H\% = (N \times 100) \cdot (N + U + E)^{-1}$
calculate H% value per cone and calculate mean value and standard deviation of 3 cones = final value
- Hatching efficiency $HE = (N \times 4 \times 800) \cdot (1.6)^{-1}$ or $HE = N \times 2000^*$ (* conversion factor to calculate for number of nauplii per gram of incubated cysts)
calculate HE value per cone and calculate mean value and standard deviation of 3 cones = final value
- Eventually leave hatching tubes for another 24 h, take subsamples again and calculate H% and HE for 48 h incubation.
- Hatching rate (HR): start taking subsamples and calculating HE from 12 h incubation in seawater onwards (follow procedure above). Continue sampling/counting procedures until mean value for HE remains constant for 3 consecutive hours. The mean values per hour are then expressed as percentage of this maximal HE. A hatching curve can be plotted and T₁₀, T₉₀ etc. extrapolated from the graph. A simplified procedure consists in sample taking e.g. every 3 or more hours.

Table 4.2.7. Practical example H% and HE.			
nauplii (n)	umbrellas (u)	embryos (e)	$H\% = \frac{n \cdot (n+u+e)}{1 \cdot 100}$
replicate 1			
110	3	17	84.62
129	4	14	87.76
122	3	13	88.41
108	2	15	86.40
117	2	16	86.67
101	3	10	88.60
average nauplii = 115			average H% = 87.08
replicate 2			
124	1	14	89.21
122	1	21	84.72
138	0	18	88.46
103	3	7	91.45
142	0	12	92.21
130	4	13	88.44
average nauplii = 127			average H% = 89.03
replicate 3			
127	3	14	88.19
107	4	10	88.43
133	2	18	86.93
135	5	13	88.24
125	1	15	88.65
128	1	15	88.89
average nauplii = 126			average H% = 88.23
average H% = $(87.08+89.03+88.23) \cdot 3^{-1} \times 100 = 88.11$ (st. dev. = 0.98)			
average HE = $(115+127+126) \cdot 3^{-1} \times 2000 = 245\ 300$ (st. dev. = 13\ 000)			

Table 4.2.8. Practical example HR.		
incubation time (in h)	HE (N.g ⁻¹)	% of maximal HE
12	0	0
13	800	0.4
14	9 000	5
15	29 400	15
16	79 800	42
17	144 400	76
18	158 200	83
19	184 600	97
20	185 000	97
21	191 000	100
Characteristic time-intervals		$T_{10} = 14.5 \text{ h}$ $T_{50} = 16.2 \text{ h}$ $T_{90} = 18.5 \text{ h}$ $T_s = T_{90} - T_{10} = 4.0 \text{ h}$

Table 4.2.9. Conversion table for various units of salinity

(density g.ml ⁻¹)	degree Baumé (°Be)	salinity (g.l ⁻¹)	density (g.ml ⁻¹)	degree Baumé (°Be)	salinity (g.l ⁻¹)
1.020	2.8	28.6	1.051	7.0	
1.021	3.0		1.054	7.5	
1.022	3.1		1.055	7.6	
1.023	3.3		1.056	7.7	
1.024	3.4		1.057	7.9	
1.025	3.6		1.058	8.0	
1.026	3.7		1.059	8.1	
1.027	3.8		1.060	8.2	84.9
1.028	4.0		1.061	8.4	
1.029	4.1		1.062	8.5	
1.030	4.2	42.4	1.063	8.7	
1.031	4.4		1.064	8.8	
1.032	4.5		1.065	8.9	
1.033	4.7		1.066	9.0	
1.034	4.8		1.067	9.2	
1.035	4.9		1.068	9.3	
1.036	5.0		1.069	9.4	
1.037	5.1		1.070	9.5	99.4
1.038	5.3		1.071	9.6	
1.039	5.4		1.072	9.7	
1.040	5.5	56.4	1.073	9.9	
1.041	5.7		1.074	10.0	
1.042	5.8		1.075	10.1	
1.043	6.0		1.076	10.2	
1.044	6.1		1.077	10.3	
1.045	6.2		1.078	10.5	
1.046	6.4		1.079	10.6	
1.047	6.5		1.080	10.7	114.1
1.048	6.7		1.081	10.8	
1.049	6.8		1.082	11.0	

Table 4.2.9. (Cont.) Conversion table for various units of salinity .

density (g.ml ⁻¹)	degree Baumé (°Be)	salinity (g.l ⁻¹)	density (g.ml ⁻¹)	degree Baumé (°Be)	salinity (g.l ⁻¹)
1.083	11.1		1.115	15.0	
1.084	11.2		1.116	15.1	
1.085	11.3		1.117	15.2	
1.088	11.7		1.118	15.3	
1.089	11.8		1.119	15.4	
1.090	11.9	128.6	1.120	15.5	
1.091	12.0		1.121	15.6	
1.092	12.1		1.122	15.7	
1.093	12.3		1.123	15.8	
1.094	12.4		1.124	15.9	
1.095	12.5		1.125	16.0	
1.096	12.6		1.126	16.2	
1.097	12.7		1.127	16.3	
1.098	12.8		1.128	16.4	
1.099	13.0		1.129	16.5	
1.100	13.1	144.0	1.130	16.6	190.6
1.101	13.2		1.132	16.8	
1.102	13.4		1.135	17.1	
1.103	13.5		1.136	17.3	
1.104	13.6		1.137	17.4	
1.105	13.7		1.138	17.5	
1.106	13.8		1.139	17.6	
1.107	14.0		1.140	17.7	
1.108	14.2		1.141	17.8	
1.109	14.3		1.142	17.9	
1.110	14.4	159.5	1.143	18.0	
1.111	14.5		1.144	18.1	
1.112	14.6		1.145	18.2	
1.113	14.7		1.146	18.3	
1.114	14.9		1.147	18.5	

Table 4.2.9. (Cont.) Conversion table for various units of salinity.

density (g.ml ⁻¹)	degree Baumé (°Be)	salinity (g.l ⁻¹)	density (g.ml ⁻¹)	degree Baumé (°Be)	salinity (g.l ⁻¹)
1.148	18.6		1.164	20.4	
1.149	18.7		1.165	20.5	
1.150	18.8	222.1	1.166	20.6	
1.151	19.0		1.169	20.9	
1.152	19.1		1.170	21.0	253.7
1.153	19.2		1.171	21.1	
1.154	19.3		1.172	21.2	
1.155	19.4		1.173	21.3	
1.156	19.5		1.174	21.4	
1.157	19.6		1.175	21.5	
1.158	19.7		1.176	21.6	
1.159	19.8		1.177	21.7	
1.160	19.9	237.8	1.178	21.8	
1.161	20.0				
1.162	20.2				
1.163	20.3				

Table 4.2.10. Temperature corrections (to value at 20°C) for density readings of concentrated seawater

temperature (°C)	density range (g.ml ⁻¹ at 20°C)					
	1.00	1.05	1.10	1.15	1.20	1.25
10	.002	.002	.003	.003	.003	.003
11	.002	.002	.003	.003	.003	.003
12	.001	.002	.002	.003	.003	.002
13	.001	.002	.002	.003	.002	.002
14	.001	.001	.002	.002	.002	.002
15	.001	.001	.002	.002	.002	.002
16	.001	.001	.001	.002	.002	.001
17	.001	.001	.001	.001	.001	.001
18	-	.001	.001	.001	.001	.001
19	-	-	.001	.001	-	-
20	-	-	-	-	-	-
21	-	-	.001	.001	.001	-
22	.001	.001	.001	.001	.001	.001
23	.001	.001	.001	.002	.002	.001
24	.001	.002	.002	.002	.002	.002
25	.002	.002	.003	.003	.003	.002
26	.002	.002	.003	.003	.003	.003
27	.003	.003	.004	.004	.004	.004
28	.003	.003	.004	.005	.005	.004
29	.004	.004	.005	.005	.005	.005
30	.004	.004	.005	.006	.006	.006
31	.004	.005	.006	.006	.006	.006
32	.005	.006	.006	.007	.007	.007
33	.005	.007	.007	.007	.007	.007
34	.006	.007	.007	.008	.008	.008
35	.006	.007	.008	.008	.008	.008

4.3. Use of nauplii and meta-nauplii

Greet Merchie

Laboratory of Aquaculture & Artemia Reference Center
University of Gent, Belgium

4.3.1. Harvesting and distribution

After hatching and prior to feeding the nauplii to fish/crustacean larvae, they should be separated from the hatching wastes (empty cyst shells, unhatched cysts, debris, microorganisms and hatching metabolites). Five to ten minutes after switching off the aeration, cyst shells will float and can be removed from the surface, while nauplii and unhatched cysts will concentrate at the bottom (Fig. 4.3.1.).

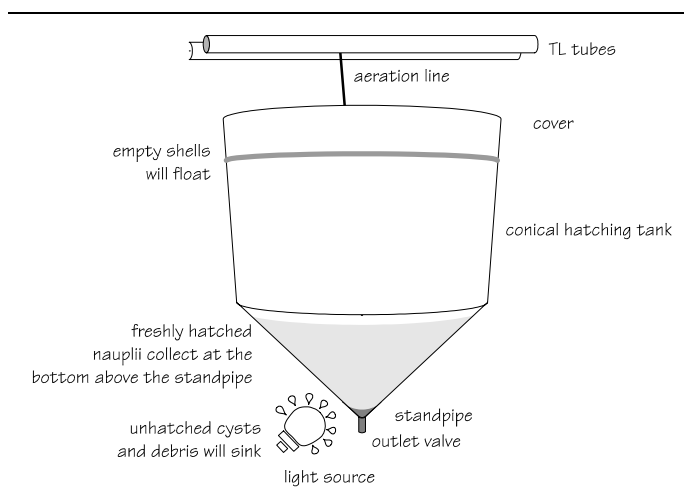

Figure 4.3.1. Hatching container at harvest.

Since nauplii are positively phototactic, their concentration can be improved by shading the upper part of the hatching tank (use of cover) and focusing a light source on the transparent conical part of the bottom. Nauplii should not be allowed to settle for too long (*i.e.*, maximum 5 to 10 min.) in the point of the conical container, to prevent dying off due to oxygen depletion. Firstly, unhatched cysts and other debris that have accumulated underneath the nauplii are siphoned or drained off when necessary (*i.e.* when using cysts of a lower hatching quality). Then the nauplii are collected on a filter using a fine mesh screen ($< 150 \mu\text{m}$), which should be submerged all the time so as to prevent physical damage of the nauplii. They are then rinsed thoroughly with water in order to remove possible contaminants and hatching metabolites like glycerol. Installation of automated systems simplify production techniques in commercial operations, (*i.e.* by the use of a concentrator/rinser; Fig 4.3.2.) that enables fast harvesting of large volumes of *Artemia* nauplii and allows complete removal of debris from the hatching medium. This technique results in a significant reduction of labour and production costs.



Figure 4.3.2. Concentrator/rinser in use (Photo from Sorgeloos and Léger, 1992).

As the live food is suspected to be a source of bacterial infections eventually causing disease problems in larval rearing, microbial contamination should be kept to a minimum. During the hatching of *Artemia* cysts, bacterial numbers increase by 10^3 to 10^5 compared to the initial population before the breaking of the cysts. This bacterial population remains well established and cannot be removed from the nauplii by rinsing with seawater or freshwater; rinsing only having a diluting effect on the water surrounding the nauplii. However, hatching nauplii from cysts that have been submitted to a disinfection procedure successfully reduces the bacterial numbers after harvesting compared to standard hatching techniques using non-disinfected cysts (Fig. 4.3.3.); in particular *Vibrio* levels are reduced below 10^3 CFU.g⁻¹. At the moment of writing a new disinfected cyst product has become commercially available (namely DC-cysts, INVE Aquaculture NV, Belgium) which has proved to result in low bacterial numbers after hatching.

Since instar I nauplii completely thrive on their energy reserves they should be harvested and fed to the fish or crustacean larvae in their most energetic form, (i.e. as soon as possible after hatching). For a long time farmers have overlooked the fact that an *Artemia* nauplius in its first stage of development can not take up food and thus consumes its own energy reserves. At the high temperatures applied for cyst incubation, the freshly-hatched *Artemia* nauplii develop into the second larval stage within a matter of hours. It is important to feed first-instar nauplii to the predator rather than starved second-instar meta-nauplii which have already consumed 25 to 30% of their energy reserves within 24 h after hatching (Fig. 4.3.4.). Moreover, instar II *Artemia* are less visible as they are transparent, are larger and swim faster than first instar larvae, and as a result consequently are less accessible as a prey. Furthermore they contain lower amounts of free amino acids, and their lower individual organic dry weight and energy content will reduce the energy uptake by the predator per hunting effort. All this may be reflected in a reduced growth of the larvae, and an increased *Artemia* cyst bill as about 20 to 30% more cysts will be needed to be hatched to feed the same weight of starved meta-nauplii to the predator (Léger *et al.*, 1986). On the other hand, instar II stages may be more susceptible to digestive enzyme breakdown in the gut of the predator since these enzymes can also penetrate the digestive tract of the *Artemia* through the opened mouth or anus.

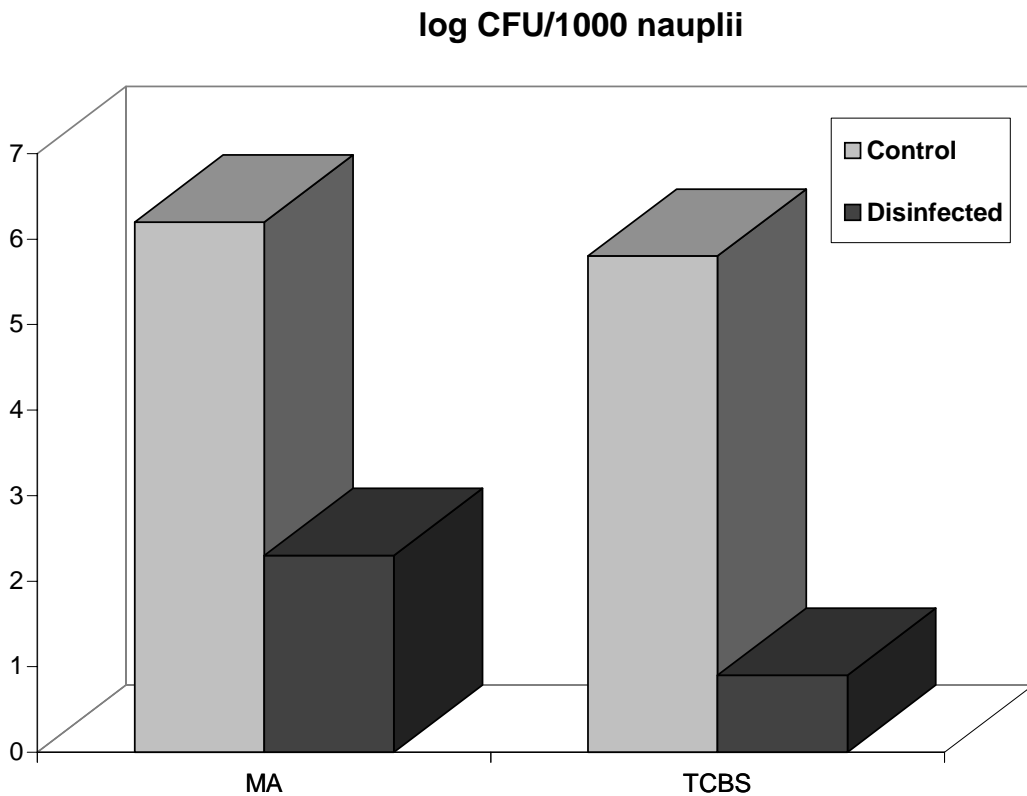

Figure 4.3.3. Bacterial counts (on marine agar MA and TCBS for hatched *Artemia* using disinfected cysts vs. control.

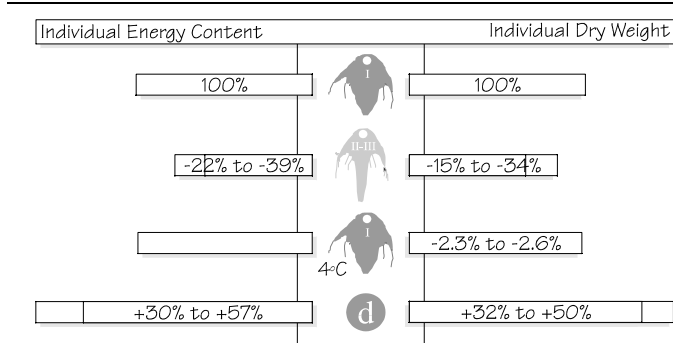

Figure 4.3.4. Change in energy and dry weight of different forms of *Artemia* (newly hatched instar I nauplii are considered to have 100 % values for those variables). The % decrease or increase is shown for Instar I, Instar II-III meta-nauplii, Instar I nauplii stored at 4 °C for 24 h, and decapsulated cysts (from Léger *et al.*, 1987a).

4.3.2. Cold storage

Molting of the *Artemia* nauplii to the second instar stage may be avoided and their energy metabolism greatly reduced (Fig. 4.3.4.) by storage of the freshly-hatched nauplii at a temperature below 10°C in densities of up to 8 million per liter. Only a slight aeration is needed in order to prevent the nauplii from accumulating at the bottom of the tank where they would suffocate. In this way nauplii can be stored for periods up to more than 24 h without significant mortalities and a reduction of energy of less than 5%. Applying 24-h cold storage using styrofoam insulated tanks and blue ice packs or ice packed in closed plastic bags for cooling, commercial hatcheries are able to economize their *Artemia* cyst hatching efforts (i.e., reduction of the number of hatchings and harvests daily, fewer tanks, bigger volumes). Furthermore, cold storage allows the farmer to consider more frequent and even automated food distributions of an optimal live food. This appeared to be beneficial for fish and shrimp larvae as food retention times in the larviculture tanks can be reduced and hence growth of the *Artemia* in the culture tank can be minimized. For example, applying one or maximum two feedings per day, shrimp farmers often experienced juvenile *Artemia* in their larviculture tanks competing with the shrimp postlarvae for the algae. With poor hunters such as the larvae of turbot *Scophthalmus maximus* and tiger shrimp *Penaeus monodon*, feeding cold-stored, less active *Artemia* furthermore results in much more efficient food uptake.

4.3.3. Nutritional quality

The nutritional effectiveness of a food organism is in the first place determined by its ingestibility and, as a consequence by its size and form. Naupliar size, varying greatly from one geographical source of *Artemia* to another, is often not critical for crustacean larvae, which can capture and tear apart food particles with their feeding appendages. For marine fish larvae that have a very small mouth and swallow their prey in one bite the size of the nauplii is particularly critical. For example, fish larvae that are offered oversized *Artemia* nauplii may starve because they cannot ingest the prey. For at least one species, the marine silverside *Menidia menidia*, a high correlation exists between the naupliar length of *Artemia* and larval fish mortality during the five days after hatching: with the largest strains of *Artemia* used (520 µm nauplius length), up to 50% of the fish could not ingest their prey and starved to death whereas feeding of small *Artemia* (430 µm) resulted in only 10% mortality (Fig. 4.3.5.). Fish that produce small eggs, such as gilthead seabream, turbot and grouper must be fed rotifers as a first food because the nauplii from any *Artemia* strain are too large. In these cases, the size of nauplii (of a selected strain) will determine when the fish can be switched from a rotifer to an *Artemia* diet. As long as prey size does not interfere with the ingestion mechanism of the predator, the use of larger nauplii (with a higher individual energy content) will be beneficial since the predator will spend less energy in taking up a smaller number of larger nauplii to fulfill its energetic requirements. Data on biometrics of nauplii from various *Artemia* strains are presented in Table 4.1.2. (see chapter 4.1.) and ranges given in Fig 4.3.6.

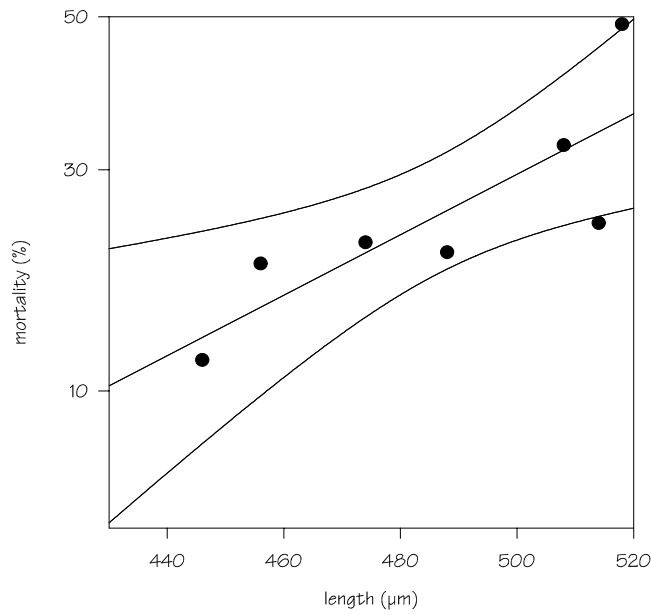

Figure 4.3.5. Correlation of mortality rate of *Menidia menidia* larvae and nauplii length of *Artemia* from seven geographical sources offered as food to fish larvae (modified from Beck and Bengtson, 1982).

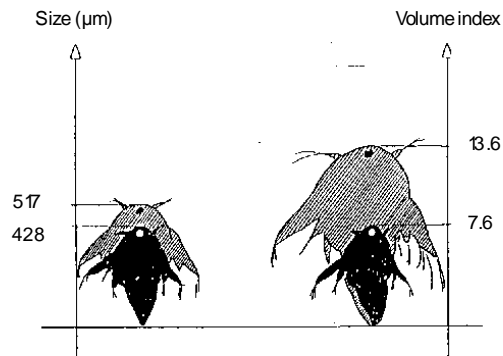

Figure 4.3.6. Schematic diagram of the biometrical variation in freshly-hatched instar I *Artemia* nauplii from different geographical origin (size = nauplius length; volume index = CoulterCounter)

Another important dietary characteristic of *Artemia* nauplii was identified in the late 1970s and early 1980s, when many fish and shrimp hatcheries scaled up their production and reported unexpected problems when switching from one source of *Artemia* to another. Japanese, American and European researchers studied these problems and soon confirmed variations in nutritional value when using different geographical sources of *Artemia* for fish and shrimp species. The situation became more critical when very significant differences in production yields were obtained with distinct batches of the same geographical origin of *Artemia*.

Studies in Japan and the multidisciplinary International Study on *Artemia* revealed that the concentration of the essential fatty acid (EFA) 20:5n-3 eicosapentaenoic acid (EPA) in *Artemia* nauplii was determining its nutritional value for larvae of various marine fishes and crustaceans (Léger *et al.*, 1986). Various results were obtained with different batches of the same geographical *Artemia* source, containing different amounts of EPA and yielding proportional results in growth and survival of *Mysidopsis bahia* shrimps fed these *Artemia*. Levels of this EFA vary tremendously from strain to strain and even from batch to batch (Table 4.3.1.), the causative factor being the fluctuations in biochemical composition of the primary producers available to the adult population. Following these observations, appropriate techniques have been developed for improving the lipid profile of deficient *Artemia* strains (see further). Commercial provisions of *Artemia* cysts containing high EPA levels are limited and consequently, these cysts are very expensive. Therefore, the use of the high-EPA cysts should be restricted to the feeding period when feeding of freshly-hatched nauplii of a small size is required.

In contrast to fatty acids, the amino acid composition of *Artemia* nauplii seems to be remarkably similar from strain to strain, suggesting that it is not environmentally determined in the manner that the fatty acids are.

Table 4.3.1. Intra-strain variability of 20:5n-3 (EPA) content in *Artemia*. Values represent the range (area percent) and coefficient of variation of data as compiled by Léger *et al.* (1986).

Cyst source	20:5n-3 range (area %)	Coefficient of variation (%)
San Francisco Bay, CA-USA	0.3-13.3	78.6
Great Salt Lake (South arm), UT-USA	2.7-3.6	11.8
Great Salt Lake (North arm), UT-USA	0.3-0.4	21.2
Chaplin Lake, Canada	5.2-9.5	18.3
Macau, Brazil	3.5-10.6	43.2
Bohai Bay, PR China	1.3-15.4	50.5

The levels of essential amino acids in *Artemia* are generally not a major problem in view of its nutritional value, but sulphur amino acids, like methionine, are the first limiting amino acids (Table 4.3.2.).

The presence of several proteolytic enzymes in developing *Artemia* embryos and *Artemia* nauplii has led to the speculation that these exogenous enzymes play a significant role in the breakdown of the *Artemia* nauplii in the digestive tract of the predator larvae. This has become an important question in view of the relatively low levels of digestive enzymes in many first-feeding larvae and the inferiority of prepared feeds *versus* live prey.

Table 4.3.2. Amino acid composition of *Artemia* nauplii (mg.g⁻¹ protein) (modified from Seidel *et al.*, 1980).

	Macau, Brazil	Great Salt Lake, UT-USA	San Pablo Bay, CA-USA
aspartic acid	110	113	141
threonine	52	48	60
serine	45	54	77
glutamic acid	131	135	102
proline	57	59	49
glycine	60	60	74
alanine	46	49	42
valine	53	52	55
methionine	22	37	26
isoleucine	56	68	54
leucine	89	100	84
tyrosine	105	66	77
phenylalanine	51	85	104
histidine	49	27	35
lysine	117	93	87
arginine	115	97	98

The levels of certain minerals in *Artemia*, have been summarized by Léger *et al.* (1986). However, although the mineral requirements of marine organisms are poorly understood and may be satisfied through the consumption of seawater, the main concern regarding the mineral composition of *Artemia* is whether they meet the requirements of fish or crustacean larvae reared in freshwater. For example, a recent study of the variability of 18 minerals and trace elements in *Artemia* cysts revealed that the levels of selenium in some cases may not be present in sufficient quantities.

Artemia cysts (San Francisco Bay) were analysed for the content of various vitamins and were found to contain high levels of thiamin ($7\text{-}13\ \mu\text{g.g}^{-1}$), niacin ($68\text{-}108\ \mu\text{g.g}^{-1}$), riboflavin ($15\text{-}23\ \mu\text{g.g}^{-1}$), pantothenic acid ($56\text{-}72\ \mu\text{g.g}^{-1}$) and retinol ($10\text{-}48\ \mu\text{g.g}^{-1}$). A stable form of vitamin C (ascorbic acid 2-sulphate) is present in *Artemia* cysts. This derivative is hydrolysed to free ascorbic acid during hatching, the -ascorbic acid levels in *Artemia* nauplii varying from 300 to $550\ \mu\text{g g}^{-1}$ DW. The published data would appear to indicate that the levels of vitamins in *Artemia* are sufficient to fulfill the dietary requirements recommended for growing fish. However, vitamin requirements during larviculture, are still largely unknown, and might be higher due to the higher growth and metabolic rate of fish and crustacean larvae.

4.3.4. Enrichment with nutrients

As mentioned previously, an important factor affecting the nutritional value of *Artemia* as a food source for marine larval organisms is the content of essential fatty acids, eicosapentaenoic acid (EPA: 20:5n-3) and even more importantly docosahexaenoic acid (DHA: 22:6n-3). In contrast to freshwater species, most marine organisms do not have the capacity to biosynthesize these EFA from lower chain unsaturated fatty acids, such as linolenic acid (18:3n-3). In view of the fatty acid deficiency of *Artemia*, research has been conducted to improve its lipid composition by prefeeding with (n-3) highly unsaturated fatty acid (HUFA)-rich diets. It is fortunate in this respect that *Artemia*, because of its primitive feeding characteristics, allows a very convenient way to manipulate its biochemical composition. Thus, since *Artemia* on molting to the second larval stage (*i.e.* about 8 h following hatching), is non-selective in taking up particulate matter, simple methods have been developed to incorporate lipid products into the brine shrimp nauplii prior to offering them as a prey to the predator larvae. This method of bioencapsulation, also called *Artemia* enrichment or boosting (Fig. 4.3.7.), is widely applied at marine fish and crustacean hatcheries all over the world for enhancing the nutritional value of *Artemia* with essential fatty acids.

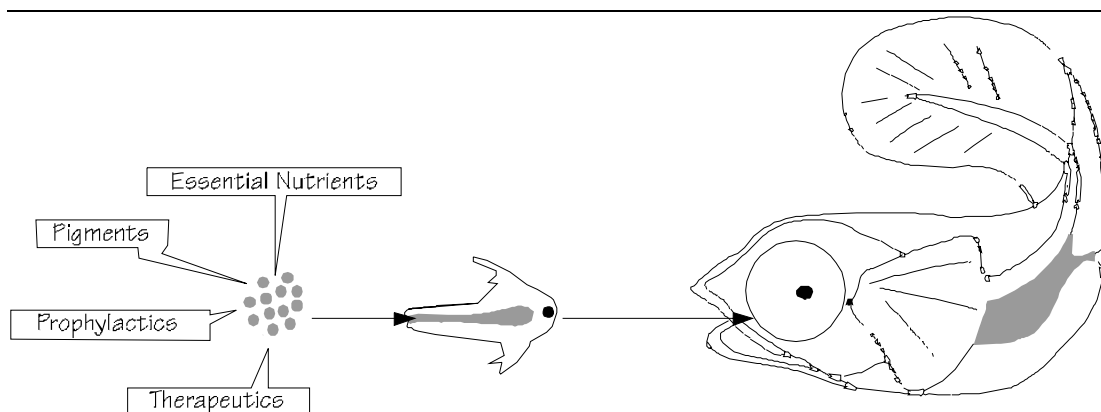

Figure 4.3.7. Schematic diagram of the use of *Artemia* as vector for transfer of specific components into the cultured larvae.

British, Japanese, French and Belgian researchers have also developed other enrichment products, including unicellular algae, ω -yeast and/or emulsified pre-preparations, compound diets, micro-particulate diets or self-emulsifying concentrates. Apart from the enrichment diet used, the different techniques vary with respect to hatching conditions, pre-enrichment time (time between hatching and addition of enrichment diet), enrichment period, and temperature. Highest enrichment levels are obtained when using emulsified concentrates (Fig. 4.3.8., Table 4.3.3.).

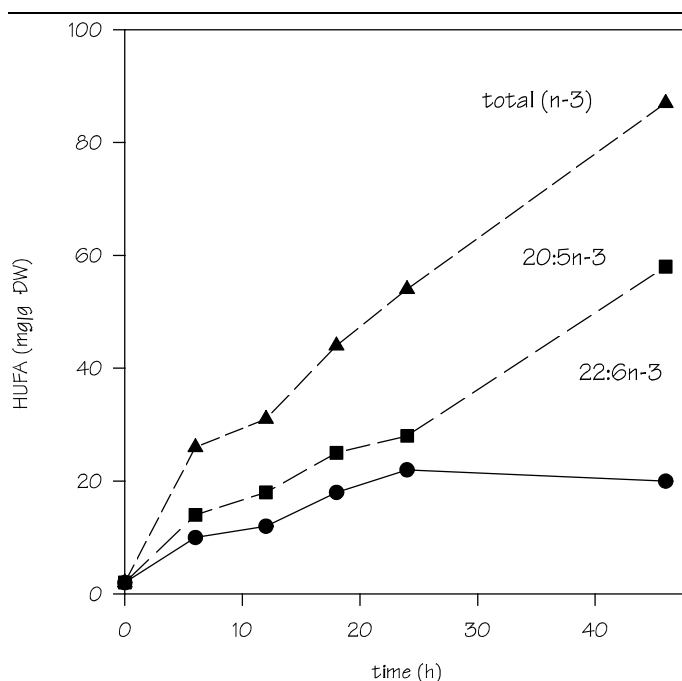

Figure 4.3.8. HUFA-levels in Great Salt Lake (Utah, USA) *Artemia* (meta-) nauplii enriched with Super Selco® (INVE Aquaculture NV, Belgium) (modified from Dhont *et al.*, 1993).

Table 4.3.3. Enrichment levels (mg.g⁻¹ DW) in *Artemia* nauplii boosted with various products

	DHA	EPA	(n-3) HUFA
Super Selco (INVE Aquaculture NV)	14.0	28.6	50.3
DHA Selco (INVE Aquaculture NV)	17.7	10.8	32.7
Superartemia (Catvis)	9.7	13.2	26.3
SuperHUFA (Salt Creek)	16.4	21.0	41.1

The Selco diet is a self-dispersing complex of selected marine oil sources, vitamins and carotenoids. Upon dilution in seawater, finely dispersed stable microglobules are formed which are readily ingested by *Artemia* and which bring about EFA-enrichment levels which largely surpass the values reported in the literature (Léger *et al.*, 1986). For enrichment the freshly-hatched nauplii are transferred to an enrichment tank at a density of 100 (for enrichment periods that may exceed 24 h) to 300 nauplii.ml⁻¹ (maximum 24-h enrichment period); the enrichment medium consisting of disinfected seawater maintained at 25°C. The enrichment emulsion is usually added in consecutive doses of 300 mg.l⁻¹ every 12 h with a strong aeration (using airstones) being required so as to maintain dissolved oxygen levels above 4 mg.l⁻¹ (the latter being necessary to avoid mortalities). The enriched nauplii are harvested after 24 h (sometimes even after 48 h), thoroughly rinsed and then fed directly or stored at below 10°C so as to minimize the metabolism of HUFA prior to administration, (*i.e.* HUFA levels being reduced by 0-30% after 24 h at 10°C, Fig. 4.3.9). By using these enrichment techniques very high incorporation levels of EFA can be attained that are well above the maximal concentrations found in natural strains. These very high enrichment levels are the result not only of an optimal product composition and presentation, but also of proper enrichment procedures: *i.e.* the nauplii being transferred or exposed to the enrichment medium just before first feeding, and opening of the alimentary tract (instar II stage). Furthermore, size increase during enrichment will be minimal: *Artemia* enriched according to other procedures reaching > 900 µm, whereas here, high enrichment levels are acquired in nauplii measuring 660 µm (after 12-h enrichment) to 790 µm (after 48-h enrichment, Fig. 4.3.10.). Several European marine fish hatcheries apply, therefore, the following feeding regime, switching from one *Artemia* diet to the next as the fish larvae are able to accept a larger prey: only at the start of *Artemia* feeding is a selected strain yielding small freshly-hatched nauplii with a high content of EPA (10 mg g⁻¹ DW) used, followed by 12-h and eventually 24-h (n-3) HUFA enriched *Artemia* meta-nauplii. Work is still ongoing to further standardise the bioencapsulation technique (*i.e.* using disinfected cysts, applying standard aeration methods). In fact, the results of laboratory testing still reveal a high variability in the essential fatty acid composition of *Artemia* nauplii, even if they are enriched by the same person or by various persons (Table 4.3.4.). For example, there was no reduction in variability when only one person handled the standard enrichment procedure instead of different people; (n-3) HUFA varying from 15 to 28% or 22 to 68 mg.g⁻¹ DW and 16 to 30% or 32 to 64 mg.g⁻¹ DW, respectively. Furthermore, results of a field study indicate that the average (n-3) HUFA levels in enriched *Artemia* meta-nauplii varied among hatcheries from 2.8 to 4.7% on a DW basis (Table 4.3.4.). In this study only one hatchery managed to keep the variability in the (n-3) HUFA content after enrichment below 9% (CV of the data in mg.g⁻¹ DW).

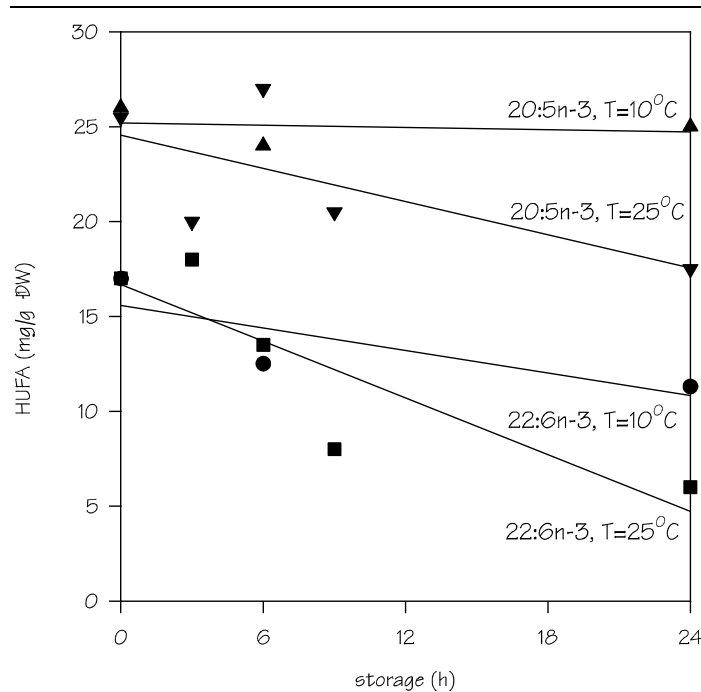

Figure 4.3.9. HUFA levels in 24-h Super Selco®-enriched *Artemia metanauplii* during storage at 10 and 25 °C (modified from Dhont *et al.*, 1993).

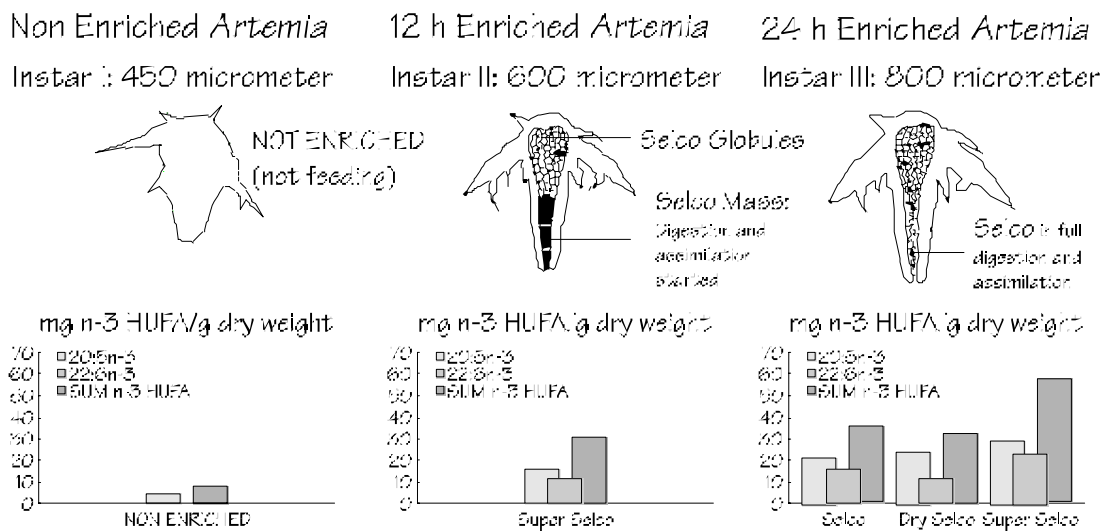

Figure 4.3.10. HUFA-levels in *Artemia meta-nauplii* enriched for 24 h using different self-emulsifying concentrates : Selco®, Super Selco®, high-DHA Super Selco® (INVE Aquaculture NV, Belgium).

In view of the importance of DHA in marine fish species a great deal of effort has been made to incorporate high DHA/EPA ratios in live food. To date, the best results have been obtained with enrichment emulsions fortified with DHA (containing a DHA/EPA ratio up to 7), yielding *Artemia* meta-nauplii that contain 33 mg DHA.g⁻¹ DW. Compared to enrichment with traditional products, a maximum DHA/EPA ratio of 2 instead of 0.75 can be reached using standard enrichment practices.

The reason for not attaining the same ratio is the inherent catabolism of DHA upon enrichment within the most commonly used *Artemia* species (i.e. *A. franciscana*). The capability of some Chinese *Artemia* strains to reach high DHA levels during enrichment and to maintain their levels during subsequent starvation might open new perspectives to provide higher dietary DHA levels and DHA/EPA ratios to fish and crustacean larvae.

Apart from EFA, other nutrients such as vitamins and pigments can be incorporated in *Artemia*. Fat soluble vitamins (especially vitamin A and vitamin E) were reported to accumulate in *Artemia* over a short-term (9 h) enrichment period with vitamin A levels increasing from below 1 IU.g⁻¹ (WW basis) to over 16 IU.g⁻¹ and vitamin E levels increasing from below 20 µg.g⁻¹ to about 250 µg.g⁻¹. Recently tests have also been conducted to incorporate ascorbic acid into live food. Using the standard enrichment procedure and experimental self-emulsifying concentrates containing 10, 20 and 30% (on a DW basis) of ascorbyl palmitate (AP) in addition to the triglycerides, high levels of free ascorbic acid (AA) can be incorporated into brine shrimp nauplii (Fig. 4.3.11.). For example, a 10%-AP inclusion in the emulsion enhances AA levels within freshly-hatched nauplii by 50% from natural levels (500 µg g⁻¹ DW). By contrast, however, a 20 or 30% addition increases AA levels in *Artemia* 3-fold and 6-fold respectively after 24 h enrichment at 27°C; with (n-3) HUFA levels remaining equal compared to normal enrichment procedures. Moreover, these AA

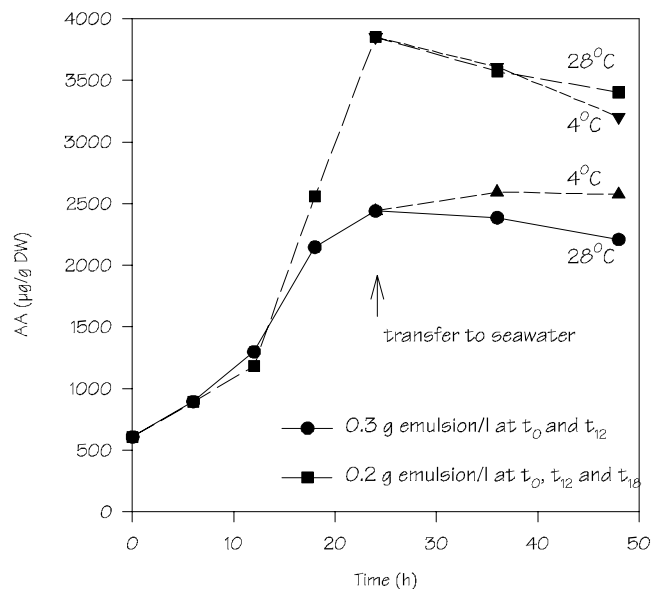

Figure 4.3.11. Ascorbic acid enrichment in *Artemia* nauplii.

concentrations do not decrease when the enriched nauplii are stored for 24 h in seawater (Fig. 4.3.11.).

Table 4.3.4. Variability in DHA, EPA and total (n-3) HUFA levels in enriched *Artemia* nauplii sampled in the laboratory (A) using a standard procedure and in three sea bream hatcheries (B) according to the in-house method (mean and sd) (modified from Lavens *et al.*, 1995)

	DHA		EPA		(n-3) HUFA	
	area %	mg g ⁻¹	area %	mg g ⁻¹	area %	mg g ⁻¹
A :						
applied by the same person (n=10)						
	7.1 ± 2.5	12.5 ± 6.5	13.8 ± 2.2	24.2 ± 5.7	23.5 ± 4.5	41.9 ± 13.1
applied by different people over a 2-month period (n=5)						
	6.2 ± 0.9	11.3 ± 2.6	14.5 ± 4.1	27.0 ± 9.9	23.3 ± 5.1	43.0 ± 12.9
applied by different people over a 2-year period (n=13)						
	7.8 ± 2.2	17.0 ± 5.8	16.7 ± 2.3	35.7 ± 7.6	26.7 ± 4.8	57.4 ± 14.2
B :						
1 (n=2)	3.8 ± 2.5	8.1 ± 6.3	9.9 ± 4.0	20.3 ± 1.2	16.1 ± 7.1	33.2 ± 19.7
2 (n=3)	5.9 ± 2.4	8.1 ± 1.4	10.5 ± 1.1	15.9 ± 5.4	20.0 ± 5.8	28.5 ± 6.4
3 (n=3)	6.1 ± 0.6	12.6 ± 1.5	14.2 ± 0.8	29.1 ± 2.3	12.6 ± 1.5	46.6 ± 4.0

4.3.5. Enrichment for disease control

The incidence of microbial diseases has increased dramatically along with the degree of intensification in the larval production of aquaculture species. Treating microbial infections in fish and shrimp larvae is most often carried out by dissolving relatively high doses of broad spectrum antibiotics in the culture water. A major disadvantage of this method is that large amounts of expensive drugs are used and subsequently discharged into the environment, and thereby placing the animal and human health at risk. However, a direct treatment through the food chain (i.e. through oral administration) using much smaller quantities has proven to be more effective and safer for the environment. In this respect the possibility of

loading *Artemia* nauplii with doses of up to $300 \mu\text{g.g}^{-1}$ DW of the therapeutic mixture Trimetoprim: Sulfamethoxazole (1:5), using self-emulsifying concentrates containing 10% of the mixture, has been demonstrated (Table 4.3.5.). This bioencapsulation technique eventually yielded levels up to $20 \mu\text{g.g}^{-1}$ antibiotics within European sea bass larvae 3 h after feeding one dosage of antibiotic-enriched *Artemia* meta-nauplii (Fig. 4.3.12.). In turbot larvae even higher tissue levels have been obtained, with a maximum tissue concentration of $90 \mu\text{g antibiotics.g}^{-1}$ was reached 4 h post feeding. Prophylactic and therapeutic efficiency was tested by feeding medicated *Artemia* respectively prior to and after an oral challenge with a pathogenic *Vibrio anguillarum* strain. In both cases mortality was significantly reduced in the treated turbot compared to the untreated controls. Of course, enrichment levels as well as therapeutic efficiency will depend on the antibiotics used. In fact, the same enrichment procedure can also be used to incorporate and transfer vaccines to fish larvae, and by so doing facilitating oral vaccination.

Table 4.3.5. Accumulation of trimetoprim (TMP) and sulfamethoxazole (SMX) in *Artemia* nauplii after 24 h enrichment using an enrichment emulsion containing TMP:SMX (1:5).

	ng.mg ⁻¹ protein	ng.mg ⁻¹ dry weight
TMP	212.1	77.8
SMX	579.3	212.4
TMP+SMX	791.4	291.1

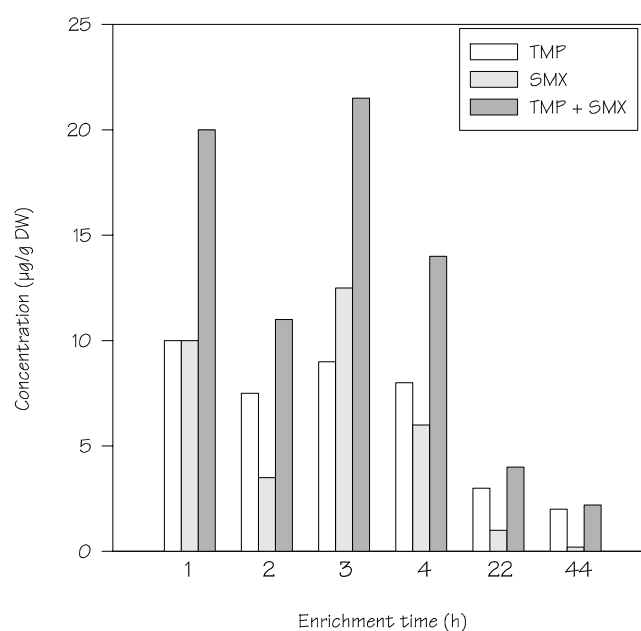

Figure 4.3.12. Incorporation and storage of trimetoprim (TMP) and sulfamethoxazole (SMX) in European sea bass larvae fed antibiotic-enriched *Artemia* nauplii.

4.3.6. Applications of *Artemia* for feeding different species

4.3.6.1. Penaeid shrimp

Artemia is generally used for feeding the late larval and postlarval stages of penaeids. Freshly-hatched nauplii are usually offered at the start of the first mysis stage, and sometimes even earlier at the zoea-mysis molt with some authors even recommending the introduction of *Artemia* during the second zoea stage.

Table 4.3.6. Typical feeding regime for *Penaeus* (*P. vannamei*) larvae.

Substage	<i>Chaetoceros neogracile</i> (cells.ml ⁻¹)	<i>Tetraselmis chuii</i> (cells.ml ⁻¹)	<i>Artemia</i> (nauplii.ml ⁻¹)
N ₅ or N ₆	60000	0-15000	0
P ₁	100000-120000	30000	0
P ₂	120000	35000	0
P ₃	120000	35000	0-0.5
M ₁	100000	30000	0.2-1.5
M ₂	75000	20000	1.5-5.0
M ₃	50000-75000	20000	3-8
PL ₁ to PL ₅	20000-75000	5000-20000	6-20

However, penaeids are usually fed algae prior to the *Artemia* and undergo a several-day weaning period when both foods are given. Thus, the addition of *Artemia* too early in the life cycle may result in the competition for the algal food between the uneaten *Artemia* and the penaeids. A convenient solution may be the early administration of killed nauplii (short dip in a water bath at 80°C; or frozen in thin layers at -10°C) or the use of decapsulated *Artemia* cysts. Enriched *Artemia* nauplii can also be administered from the postlarval stages onwards.

Increased survival and growth have been confirmed for several penaeid species fed (n-3) HUFA-enriched diets, although often the effects of diet composition only become apparent in later stages (Fig. 4.3.13). A good illustration of this is the resistance to salinity stress in PL-10 stages of a batch of *Penaeus monodon* larvae fed on three different larval diets that varied in (n-3) HUFA levels. Thus, although no significant differences in survival were observed between treatments before the stress test, pronounced differences in PL-quality (expressed as their ability to survive the salinity stress applied) were observed (Fig 4.3.14).

This criterion of resistance to salinity shocks which can easily be applied at the hatchery level is now commonly being used as a quality criterion for determining the appropriate time for PL-transfer from the hatchery to the pond. Recent studies exploring quantitative dietary requirements as well as the relative importance of selected HUFA (i.e. DHA) showed that feeding *Artemia* enriched with medium levels of 12.5 mg HUFA.g⁻¹ DW (DHA/EPA ratio of 0.4) considerably enhanced the survival of *P. monodon* PL-15 and the osmotic resistance of PL-10. This has recently been confirmed with the production characteristics of *P. monodon* PL-10 and PL-20 being significantly improved when HUFA-fortified *Artemia* (32 mg.g⁻¹ DW) were administered in comparison to low-HUFA *Artemia* (4 mg.g⁻¹ DW). However, no significant differences were revealed in function of various DHA/EPA ratios for the production output, apparently indicating that there is no specific requirement for DHA over EPA in postlarval shrimp.

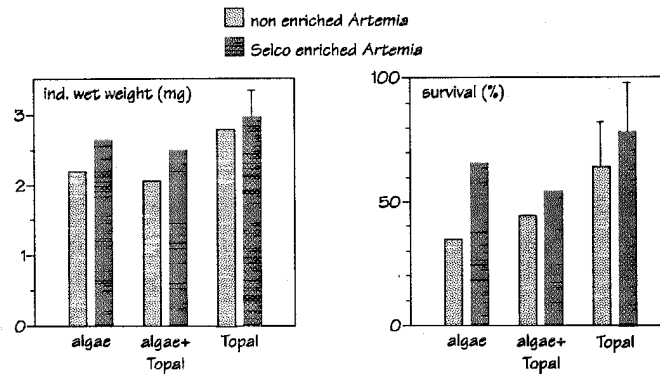

Figure 4.3.13. Larviculture outputs with *P. vannamei* reared up to PL 8 in 200 l tanks on diets consisting of only algae (mixture of *Chaetoceros* and *Tetraselmis*) or the algae substitute Topal (INVE Aquaculture NV, Belgium), or a mixture of both up to M 2 stage; each treatment was split up as from the M 3 stage in a group fed only freshly-hatched *Artemia* (HUFA composition: 5-6% 20:5n-3; no 22:6n-3; pale bars) and a group receiving 12 h Selco[®]-enriched *Artemia* (6.4 % 20:5n-3 and 3.3% 22:6n-3) in M 3 and PL 1 stage, followed by 24 h Selco[®]-enriched *Artemia* (21.3% 20:5n-3 and 12.7 % 22:6n-3) in the later PL stages; dark bars (modified from Léger *et al.*, 1987).

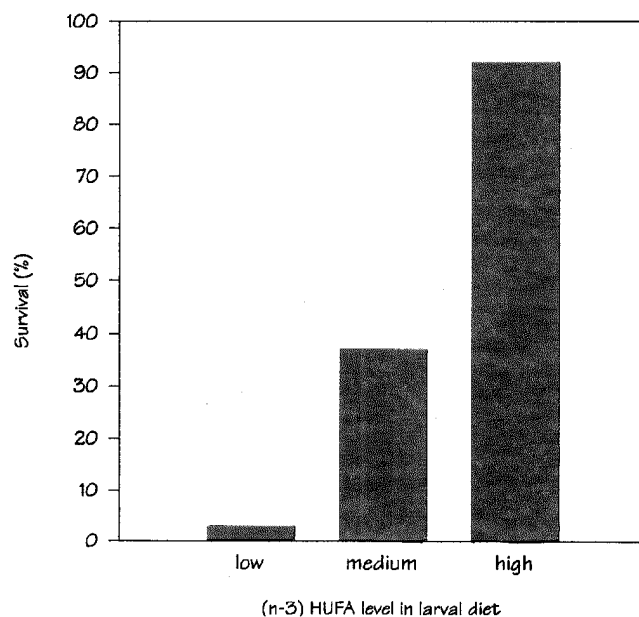

Figure 4.3.14. Survival of *P. Monodon* PL10 cultured on larval diet combinations containing low, medium and high levels of (n-3) HUFA after 60 min. transfer from 35 to 7 g.l⁻¹ seawater (modified from Sorgeloos and Léger, 1992).

4.3.6.2. Freshwater prawn

Artemia nauplii is the most successful diet employed for the larval rearing of freshwater prawn larvae. In contrast to penaeid shrimp, *Macrobrachium* can initially be fed with freshly-hatched *Artemia* nauplii, at densities higher than 0.1 nauplii.ml⁻¹ to ensure proper ingestion (Table 4.3.7).

Energy intake in *M. rosenbergii* was directly proportional not only to *Artemia* concentration but also to *Artemia* size the (n-3) HUFA-requirements of *Macrobrachium* were anticipated not to be very critical in view of the fact that these animals spend most of their life in freshwater.

Table 4.3.7. Variations of food amount per larva per day during larval rearing (Aquacop, 1983).

Day	<i>Artemia</i> nauplii	Pellets (µg DW)
3	5	0
4	10	0
5-6	15	0
7	20	0
8	25	0
9	30	0
10-11	35	0
12	40	70
13-14	45	80-90
15-24	50	100-180
25-30	45	200
30+	40	200

These assumptions, however, were largely contradicted by a study using *Artemia* enriched with different (n-3) HUFA emulsions for the hatchery-rearing of *Macrobrachium*. Apart from their improved growth rate, a distinct difference having an important impact for the commercial farmer was the more precocious and synchronous metamorphosis as well as the higher stress resistance of *Macrobrachium* postlarvae fed (n-3) HUFA-enriched *Artemia* during the larval stage (Fig. 4.3.15.). However, it has recently been demonstrated that these effects were a function of the broodstock diet; employed with larvae obtained from females fed a HUFA-fortified diet performing equally well on non-enriched or enriched *Artemia*. Similarly, although no enhanced hatchery output was observed in larva fed vitamin C-enriched *Artemia*, vitamin C had a positive effect on the physiological condition of the postlarvae (Table 4.3.8.).

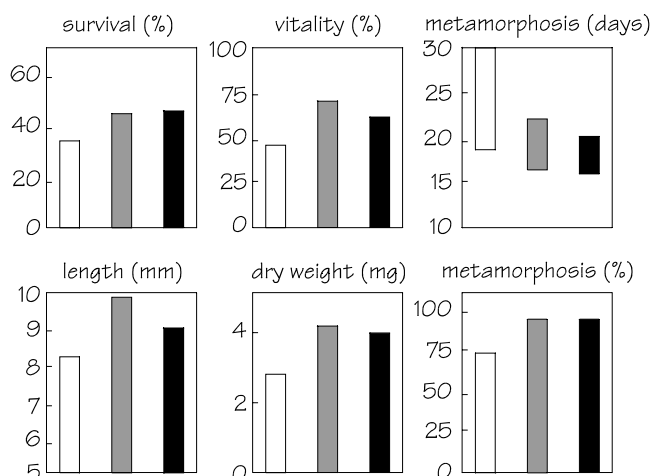

Figure 4.3.15. Results of a 28-day culture test with *Macrobrachium rosenbergii* larvae fed *Artemia* nauplii enriched with low (left open bar), medium (central grey bar) and high (right black bar) (n-3) HUFA.

Table 4.3.8. Effect of vitamin C enrichment in *Artemia* nauplii on the larviculture success of the giant freshwater prawn *Macrobrachium rosenbergii* (day 28) (Merchie *et al.*, 1995)

	experiment 1			experiment 2	
	529	2920	656	1305	2759
dietary ascorbic acid ($\mu\text{g g}^{-1}$)	529	2920	656	1305	2759
survival (%)	72.1	48.4	57.5	57.8	57.1
ind. length (mm)	9.31	9.34	9.67	9.73	9.58
ind. dry weight (μg)	831	888	1130	1200	1310
metamorphosis (%)	12.9	16.2	40.6	53.3	49.1
survival after osmotic stress (%)	8.7	32.7	40.0	62.0	74.0
ascorbic acid in larvae ($\mu\text{g.g}^{-1}$ DW)	365	552	352	448	507
ascorbic acid in PL ($\mu\text{g.g}^{-1}$ DW)	288	325	255	389	432

4.3.6.3. Marine fish

The larvae of many species of marine fish, such as gilthead seabream, grouper, and turbot, can only be offered an *Artemia* diet after an initial period on a smaller prey, such as the rotifer, *Brachionus plicatilis*. However, in contrast to crustacean larvae, marine fish larvae are usually cultured on *Artemia* for a much longer period of time, (i.e. from 20 to 40 days; Table 4.3.9.). Consequently, *Artemia* cyst consumption can be among the highest in marine fish larviculture, ranging from 200 to 500 g per 1000 fry produced. In general, instar I nauplii are fed for several days as a transition from the rotifer diet to the larger 24-h enriched preys.

The variability of the nutritional value of *Artemia* nauplii as a food source for marine fish larvae has been well documented. As mentioned previously, the application of HUFA enrichment of the *Artemia* diet has been found to have a significant effect in marine fish larviculture, and has generally resulted in increased survival and reduced variability in fish hatchery production. The latter is particularly important since it was the missing link in the development of commercial production. Furthermore, the quality of the fry in terms of stress resistance, better pigmentation, reduced deformities, better swimbladder inflation, and increased vigor, appears to have been directly correlated with the (n-3) HUFA enrichment of their larval diet.

Table 4.3.9. Typical example of feeding regime for seabass (*Dicentrarchus labrax*) reared from hatching to juveniles

Initial fish density is ± 100 larvae per l; 10-20 larvae per l during weaning; temperature 18-20 °C, salinity 35-37 g.l⁻¹ *Artemia* in millions per metric ton culture volume per day; compound diets in gram per metric ton culture volume per day or otherwise indicated in percent of fish wet weight per day

Age (days)	Wet weight (gram)	<i>Artemia</i>		Lansy compound diets (INVE Aquaculture NV, Belgium)		
		small instar I SFB-type	Selco-enriched GSL-type	Lansy R1 80-200 µm	Lansy A2 150-300µm	Lansy W3 300-500µm
0-7						
8-11		1				
12		2.5				
13-16		2.7-3.0				
17-19		5.0-7.0		2-5		
20-23		3.0-4.3	3-11	5-7		
24-27		0	14-17	7-10		
28-29			17-20	10-15		
30-34			20	10-15	10-15	
35-37			20	0	20-30	
38-41	0.05		20		30-40	
Start of weaning						
			20-15		40-50	
	0.08		15-10		45-55	15-25
			10-0		45-55	45-55

For example, the survival of European sea bass (*Dicentrarchus labrax*) appears strongly correlated with the 20:5n-3 content of *Artemia* nauplii, while growth is highly correlated with 22:6n-3 content; with all larvae fed non-enriched Great Salt Lake *Artemia* dying within 35 days, while 25% of those fed (n-3) HUFA-enriched GSL *Artemia* survived for 42 days.

Similarly, for good growth and survival in gilthead sea bream (*Sparus aurata*) larvae, the feeding regime of rotifers and brine shrimp should contain high levels of both 20:5n-3 and 22:6n-3. Moreover, the best resistance to stress conditions (*i.e.*, activity test) was displayed by larvae fed the 22:6n-3-enriched live feed. More recently, the best growth was achieved with a diet rich in (n-3) HUFA and having a high DHA/EPA ratio of 2 during the first two weeks after hatching.

Furthermore, with turbot (*Scophthalmus maximus*) (n-3) HUFA enrichment and dietary DHA/EPA ratio may also be involved in larval pigmentation. For example, recent investigations on isolated turbot cells have demonstrated that the conversion from EPA to DHA is very slow in turbot, and that direct supplementation with DHA might be beneficial for the larvae of this species. However, the dosage and boosting with DHA during the early larval stages has to be considered with extreme care since the requirements of the larvae may not only depend upon their ontogenetic stage but also on their fatty acid reserves from the yolk-sac which may in turn vary with the broodstock diet.

The necessity of incorporating DHA in the larval diet of Japanese flounder has also been proven (Table 4.3.10.): the use of DHA resulting in a much higher survival and growth rate than in the control treatment and also facilitating enhanced resistance to stress conditions (day 50). Identical experiments have also been conducted with red seabream and have been even more conclusive: the growth of DHA-fed larvae being 50% better than the control group by day 38.

Table 4.3.10. Survival, growth and stress resistance of Japanese flounder *Paralichthys olivaceus* (day 50) fed either unenriched rotifers and *Artemia* (control) or high-DHA Superselco-enriched live food (DHA) (Devresse *et al.*, 1992.

	control	DHA
survival (%)	1.8	21.5
length (mm)	19.1	28.7
stress resistance (% survival)	40.0	93.0

For the Pacific species, similar tendencies to those of the European species have been reported. For example, survival at metamorphosis and stress resistance (*i.e.*, salinity shocks) in Asian sea bass (*Lates calcarifer*) have been strongly correlated with the HUFA levels of *Artemia*. In fact, an adopted feeding strategy in which HUFA-enriched live preys are offered during a short period (2-5 days) before metamorphosis appears to be sufficient to accelerate the rate of metamorphosis and to prevent subsequent mortalities in *Lates* fry. Similarly, milkfish (*Chanos chanos*) fry showed significant increases in growth (length and dry weight) when fed HUFA-fortified *Artemia* over a three-week period. Furthermore, rabbit fish larvae (*Siganus guttatus*) fed HUFA-rich *Artemia* displayed less mortality when disturbed than controls fed HUFA-poor *Artemia*.

Until early 1988, culture trials with mahi-mahi larvae (*Coryphaena hippurus*) had only been successful when the larvae were fed natural copepods or other zooplankton; culture tests with newly-hatched *Artemia* not being successful at that time. However, In 1988 and 1989, significant progress in the larviculture of this fast-growing aquaculture species was achieved by various research groups in the U.S.A. and Australia. In particular, larvae fed *Artemia* enriched with high levels of (n-3)HUFA, and in particular DHA, resulted in more consistent larviculture outputs in terms of survival, larval growth, and health as compared to larvae cultured with other zooplankton as food.

4.3.6.4. Freshwater fish

Freshwater fish larviculture is often carried out in ponds with natural zooplankton as the larval food. The salmonids, perhaps the group cultured most widely on an intensive basis, have a relatively well-developed digestive tract at first feeding and are usually fed formulated diets from start-feeding. Nevertheless, many species of freshwater fish are fed on *Artemia*. Whitefish larvae (family *Coregonidae*) are often fed *Artemia* until they metamorphose and can be switched to a dry diet. Walleye (*Stizostedion vitreum*) larvae raised on diets of either *Artemia*, natural zooplankton, or fish larvae preferred *Artemia* as a first food. Consequently, a 15-day feeding period on brine shrimp for walleye larvae prior to being fed on traditional artificial diets. Similarly, *Artemia nauplii* are increasingly being used within the USA as a first food for striped bass larvae (*Morone saxatilis*). Interestingly, although these fish are reared in freshwater or very low-salinity water, recent evidence suggests that they may have the fatty acid requirements of a marine fish (which they eventually become at adulthood). The larvae are typically fed *Artemia* from about 5 days post-hatching until about day 20, and then weaned onto an artificial diet by day 30, after which *Artemia* feeding ceases.

Moreover, African catfish (*Clarias gariepinus*) larvae have been found to perform significantly better when fed an *Artemia* diet as compared to co-feeding with *Artemia* and a semi-purified diet (ratio 80:20). Dietary supplementation with ascorbate in the form of vitamin C-boosted *Artemia*, was also found to have a significantly positive effect on the growth of catfish larvae one week after first-feeding; the evaluation of the physiological condition of the larvae showing significantly higher resistance with increasing dietary vitamin C concentration (Fig. 4.3.16).

A major drawback in feeding *Artemia* to freshwater organisms is that the *Artemia* die after 30 to 60 minutes in freshwater. As a consequence, they are not continuously available to the predator as they would be within marine systems, and must therefore be fed intermittently every 2 to 3 hours.

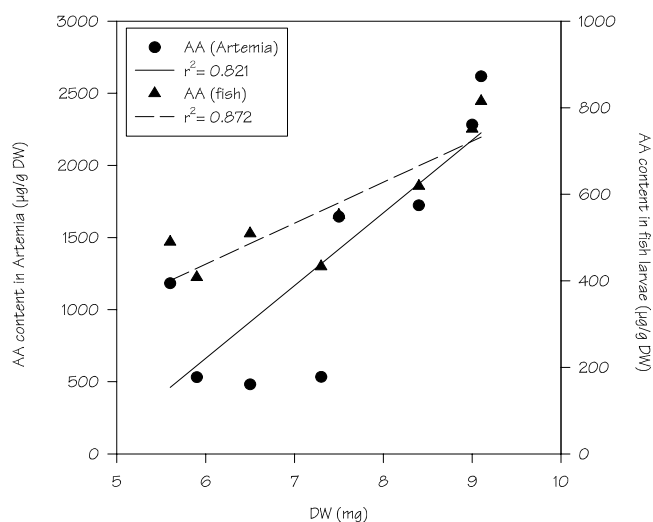

Figure 4.3.16. Linear relationship between the larval dry weight (mg) and either the dietary ascorbic acid ($\mu\text{g}\cdot\text{g}^{-1}$ DW) or the ascorbic acid incorporated ($\mu\text{g}\cdot\text{g}^{-1}$ DW) in the *Clarias gariepinus* larvae (day 8).

4.3.6.5. Aquarium fish

Both live and frozen adult *Artemia* are used as food for aquarium fish species. Cysts are also purchased by these users and hatched for feeding as nauplii. Survival, vigor and pigmentation have been reported to be significantly improved in several tropical species when (n-3) HUFA levels were increased through boosting.

4.3.7. Literature of interest

Aquacop, 1983. Intensive larval rearing of *Macrobrachium rosenbergii* in recirculating system. 1st International Biennial Conference on Warm Water Aquaculture - Crustacea, February 9-11, 1983. Brigham Young University, Hawaii, USA.

Beck, A.D., Bengtson, D.A. 1992. Study on Artemia XXII. Nutrition in Aquatic toxicology - diet quality of geographical strains of *Artemia*, p.161-169. In: Aquatic toxicology and hazard assessment. 5th Conf., ASTM STP 766. Pearson, J.G., Foster, R.B., Bishop, W.E. (Eds). Amer.Soc. Testing and Materials, Philadelphia, USA, 400 p.

Bengtson, D.A., Léger, P. and Sorgeloos, P. 1991. Use of *Artemia* as a food source for aquaculture. In: *Artemia* Biology. Browne, R.A., P. Sorgeloos and C.N.A. Trotman (Eds), CRC Press, Inc., Boca Raton, Florida, USA, pp 225-285.

- Chair, M., Dehasque, M., Sorgeloos, P., Nelis, H. and De Leenheer, A.P. 1995. Live food mediated drug delivery as a tool for disease treatment in larviculture: a case study with turbot *Scophthalmus maximus*. J. World Aquaculture Soc., 26(2):217-219
- Chair, M., Romdhane, M., Dehasque, M., Leenheer, A.P. and Sorgeloos, P.-1991. Live food mediated drug delivery as a tool for disease treatment in larviculture. II. A case study with European seabass. In: Larvi'91. Fish & Crustacean Larviculture Symposium, Lavens, P., P. Sorgeloos, E. Jaspers and F. Ollevier (Eds), European Aquaculture Society, Special Publication N°15, Ghent, Belgium, 1991, pp 412-414.
- Dehasque, M., Ooghe, B., Wille, M., Candreva, Y. and Lavens, P. 1995. Automation of live food in industrial zootechnics and economics. In: Larvi'95. Lavens, P., E. Jaspers and I. Roelants (Eds), European Aquaculture Society, Spec. Publ. No 24, Gent, Belgium, pp 325-327.
- Devresse, B., Romdhane, M., Buzzi, M., Rasowo, J., Léger, Ph., Brown, J. and Sorgeloos, P. 1990. Improved larviculture outputs in the giant freshwater prawn *Macrobrachium rosenbergii* fed a diet of *Artemia* nauplii enriched with n3-HUFA and phospholipids. World Aquaculture, 21(2):123-125.
- Devresse, B., Leger, B., Sorgeloos, P., Murata, O., Nasu, T., Ikeda, S., Rainuzzo, J.R., Reitan, K.I., Kjorsvik, E. And Olsen, Y. 1992. Improvement of flat fish pigmentation through the use of DHA enriched rotifers and Artemia. Poster presentation at the 5th International Symposium on Fish Nutrition and Feeding, 7-10 September 1992, Santiago, Chile.
- Dhert, Ph., Lavens, P., Duray, M. and Sorgeloos, P. 1990. Improved larval survival at metamorphosis of Asian seabass (*Lates calcarifer*) using ω 3- HUFA-enriched live food. Aquaculture, 90:63-74.
- Dhont, J., Lavens, P., and Sorgeloos, P. 1993. Preparation and use of *Artemia* as food for shrimp and prawn larvae. In: CRC Handbook in Mariculture, Vol. I. Crustacean Aquaculture (2nd edition). McVey, J. (Ed.), CRC Press, Boca Raton, Florida, USA, pp 61-93.
- Lavens, P., Coutteau, P. and Sorgeloos, P. 1995. Laboratory and field variation in HUFA enrichment of *Artemia* nauplii. In: Larvi'95. Lavens, P., E. Jaspers and I. Roelants (Eds), European Aquaculture Society, Spec. Publ. No 24, Gent, Belgium, pp 137-140.
- Lavens, P., Sorgeloos, P., Dhert, Ph. and Devresse, B. 1995. Larval Foods. In: Broodstock Management and Egg and Larval Quality, Bromage, N.R. and R.J. Roberts (Eds), Blackwell Science Ltd., Oxford, UK, pp 373-397.
- Léger, Ph., Vanhaecke, P. and Sorgeloos, P. 1983. International Study on *Artemia* XXIV. Cold storage of live *Artemia* nauplii from various geographical sources: Potentials and limits in aquaculture. Aquacultural Eng., 2:69-78.

- Léger, Ph., Bengtson, D.A., Simpson, K.L. and Sorgeloos, P. 1986. The use and nutritional value of *Artemia* as a food source. *Oceanogr. Mar. Biol. Ann. Rev.*, 24:521-623.
- Léger, Ph., Naessens-Foucquaert, E. and Sorgeloos, P. 1987a. International study on *Artemia*. XXXV. Techniques to manipulate the fatty acid profile in *Artemia* nauplii and the effect on its nutritional effectiveness for the marine crustacean *Mysidopsis bahia* (M.). In: *Artemia* research and its applications. Vol. 3. Ecology, culturing, use in aquaculture. Sorgeloos, P., D.A. Bengtson, W. Decler and E. Jaspers (Eds), Universa Press, Wetteren, Belgium, pp. 411-424.
- Léger, Ph., Ferraz De Queiroz, J. and Sorgeloos, P. 1987. Improved hatchery production of postlarval *Penaeus vannamei* through application of innovative feeding strategies with an algal substitute and enriched *Artemia*. Paper presented at the 18th Ann. Meeting Guayaquil (Ecuador), January 18-23, 1987.
- Léger, Ph. and Sorgeloos, P. 1992. Optimized feeding regimes in shrimp hatcheries. In: *Culture of Marine Shrimp: Principles and Practices*. A.W. Fast, Lester, L.J. (Eds), Elsevier Science Publishers, New York, USA, pp 225-244.
- Merchie, G., Lavens, P., Dhert, Ph., Dehasque, M., Nelis, H., De Leenheer, A. and Sorgeloos, P. 1995. Variation of ascorbic acid content in different live food organisms. *Aquaculture*, 134: 325-337.
- Romdhane, M.S., Devresse, B., Léger, Ph. and Sorgeloos, P. 1995. Effects of feeding (n-3) HUFA-enriched *Artemia* during a progressively increasing period on the larviculture of freshwater prawns. *Aquaculture International*, 3:236-242.
- Seidel, C.R., Schaver, P.S., Katayama, T. And Simpson, K.L. 1980. Culture of Atlantic silversides fed on artificial diets and brine shrimp nauplii. *Bull.Jap.Soc.Sci.Fish.*, 46(2):237-245.
- Sorgeloos, P., Dehasque, M. Dhert, Ph. and Lavens, P. 1995. Review of some aspects of marine fish larviculture. *ICES mar. Sci. Symp.*, 201:138-142.
- Sorgeloos, P. and Léger, Ph. 1992. Improved larviculture outputs of marine fish, shrimp and prawn. *J. World Aquaculture Soc.*, 23(4):251-264.
- Verpraet, R., Chair, M., Léger, Ph., Nelis, J., Sorgeloos, P. and De Leenheer, A.P. 1992. Live food mediated drug delivery as a tool for disease treatment in larviculture. 1. The enrichments of therapeutics in rotifers and *Artemia* nauplii. *Aquacultural Engineering*, 11:133-139.

4.3.8. Worksheets

WORKSHEET 4.3.1. : STANDARD ENRICHMENT FOR GREAT SALT LAKE *ARTEMIA*.

- Seawater disinfection
 - add 1 mg. l⁻¹ NaOCl (100 µl bleach solution . 10 l⁻¹ of 0.45 µm filtered seawater)
 - incubate 1 h
 - aerate strongly overnight
 - add 0.5 g.l⁻¹ NaHCO₃ (dissolved in deionized water and GF filtered)
- Cyst disinfection
 - cylindroconical tube
 - 4 g cysts. l⁻¹ tapwater
 - 20 min at 200 mg.l⁻¹ NaOCl (±2.0 ml bleach solution.l⁻¹)
 - harvest and rinse well, weigh out 2 x 50%
- Hatching
 - 2 cylindroconical tubes
 - add 1/2 of the cysts per litre disinfected natural seawater
 - 24 h, 28 °C, light, aeration
 - separation if needed in an aquarium in tapwater
 - make nauplii suspension of about 300 N/ml, count accurately (3 x 250 µl samples) and determine Instar I/II ratio.

- Enrichment (triplicate)
 - take volume required for 200,000 nauplii
 - rinse nauplii on sieve with filtered seawater
 - stock in 1 l cone with point and airstone aeration at 200 nauplii. ml⁻¹
 - count initial density (3 x 250 N.ml⁻¹)
 - add 2 x 0.2 g of emulsion (2 x 2 ml of 5 g. 50 ml⁻¹ diluted emulsion) over 24 h (t = 0 h and t = 10-12 h)
 - 24 h at 28 °C, monitor O₂ regularly !

- Harvesting
 - count survival, *i.e.* count dead nauplii (no lugol) and total nauplii (+lugol) from 3 x 250 µl sample per cone
 - remove all aeration
 - concentrate nauplii using light
 - siphon nauplii on sieve
 - rinse well with tapwater
 - dry sieve on paper towel
 - fill vial and freeze sample

- Results
 - initial proportion instar I/II
 - survival percentage during enrichment

- fatty acid composition of enriched *Artemia*

- Timing
 - Day 1 filter + disinfect seawater 1 h + aerate
 - Day 2 9:00 start cysts disinfection
9:30 start hatching
 - Day 3 9:30 harvest and start enrichment
18:00 add second enrichment
 - Day 4 9:30 harvest

4.4. Tank production and use of ongrown *Artemia*

Jean Dhont and Patrick Lavens

Laboratory of Aquaculture & Artemia Reference Center
University of Gent, Belgium

4.4.1. Nutritional properties of ongrown *Artemia*

The nutritional quality of *Artemia* biomass produced in semi-intensive or super-intensive systems is analogous to natural produced biomass except for the lipid content. The protein content of ongrown *Artemia*, independent of its rearing conditions or food, is appreciably higher than for instar I-nauplii (Table 4.4.1.) and is especially richer in essential amino acids (Table 4.4.2.).

On the other hand the lipid profile, quantitatively (Table 4.4.2.) as well as qualitatively, is variable and a reflection of the diet offered to the *Artemia* cultures. This does not necessarily restrict their application since high levels of essential fatty acids can easily and very quickly be attained in the *Artemia* biomass by applying simple bio-encapsulation; in less than one hour the digestive tract of the brine shrimp can be filled with a HUFA enrichment product, boosting the (n-3) HUFA content from a low level of 3 mg.g⁻¹ DW up to levels of more than 50 mg.g⁻¹ (see 4.4.2.7.).

Table 4.4.1. Comparison of the biochemical composition of Great Salt Lake nauplii and preadults harvested from superintensive culture systems. (in %; after Léger *et al.*, 1986)

<i>Artemia</i> characteristics	Proteins	Lipids	N-free extract	Ash
Instar-I nauplii	41.6 - 47.2	20.8 - 23.1	10.5 - 22.79	0.5
Cultured juveniles & adults	49.7 - 62.5	9.4 - 19.5	-	9.0 - 21.6
Wild adults	50.2 - 69.0	2.4 - 19.3	-	8.9 - 29.2

Artemia juveniles and adults are used as a nursery diet not only for their optimal nutritional value but also for energetic advantages as well. For example, when offered large *Artemia* instead of freshly-hatched nauplii, the predator larvae need to chase and ingest less prey organisms per unit of time to meet their food requirements.

This improved energy balance may result in a better growth, a faster developmental rate, and/or an improved physiological condition as has been demonstrated in lobster, shrimp, mahi-mahi, halibut and *Lates* larviculture. For the latter species, the introduction of ongrown *Artemia* as a hatchery/nursery food resulted in significant savings of *Artemia* cysts of up to 60% and consequently a significant reduction in the total larval feed cost. In the early larviculture of lobster, *Homarus spp.*, feeding biomass instead of nauplii has proven to reduce cannibalism adequately.

Table 4.4.2. Profile of fatty acids (in mg.g⁻¹ DW) and amino acids (in g. 100g⁻¹ DW) in Great Salt Lake preadults cultured under flow-through conditions on a diet of corn and soybean powder compared to nauplii (After Léger *et al.*, and Abelin, unpubl. data).

Fatty acids	preadults	Amino acids	preadults	nauplii
Saturated	16.20	Essential	26.94	55,7
14:0	0.70	tryptophan	-	-
15:0	.50	lysine	4.23	7.8
16:0	9.10	histidine	1.30	2.3
17:0	0.70	arginine	2.69	8.2
18:0	5.20	threonine	2.42	4.0
19:0	-	valine	3.20	4.4
20:0	-	methionine	0.71	3.1
24:0	-	isoleucine	2.96	5.7
Unsaturated	46.70	leucine	4.52	8.4
14:1	1.20	tyrosine	2.16	5.6
14:2	-	phenylalanine	2.75	7.2
15:0	0.30	Non-essential	25.71	39.6
16:1n-7 + 16:1n-9	4.30	asparagine	5.82	9.5
16:2	-	serine	2.63	4.5
16:3	0.30	glutamine	7.64	11.4
14:1	-	proline	3.29	5.0
18:1n-7 + 18:1n-9	18.30	glycine	2.68	5.1
18:2	15.90	alanine	3.61	4.1
18:4	0.10	cysteine	0.14	-
19:4	-			
20:1	4.00			
21:5	0.30			
22:1	2.00			
24:1	-			
Unsaturated (n-3)	9.00			
18:3	-			
20:3	0.30			
20:4	-			
20:5	2.80			
22:3	0.90			
22:4	-			
22:5	0.40			
22:6	4.60			
Unsaturated (n-6)	0.40			
18:3	-			
20:3	-			
20:4	-			
22:4	0.40			
22:5	-			

Until recently, applications with ongrown *Artemia* were never taken up at an industrial level because of the limited availability of live or frozen biomass, its high cost and variable quality. Technologies developed in the eighties for establishing intensive pond and super-intensive tank production systems of brine shrimp in or near the aquaculture farm have resulted in increased interest for *Artemia* biomass during the last decade.

In China, several thousand tons of *Artemia* biomass have been collected from the Bohai Bay salt ponds and used in the local hatcheries and grow-out facilities for Chinese white shrimp, *Penaeus chinensis*. In addition, the aquarium pet shop industry offers good marketing opportunities for live *Artemia* biomass produced in regional culture systems. Today, over 95% of the more than 3000 metric tons of *Artemia* biomass that are marketed in this sector are sold frozen since they are harvested from a restricted number of natural sources and live transportation to other continents is cost prohibitive. Singapore, for example, already experiences a bottleneck where the local tropical aquarium industry is threatened by a shortage of live foods.

4.4.2. Tank production

4.4.2.1. Advantages of tank production and tank produced biomass

Although tank-produced *Artemia* biomass is far more expensive than pond-produced brine shrimp, its advantages for application are manifold :

- year-round availability of ongrown *Artemia*, independent of climate or season;
- specific stages (juveniles, preadult, adults) or prey with uniform size can be harvested as a function of the size preferences of the predator; and
- quality of the *Artemia* can be better controlled (*i.e.* nutritionally, free from diseases).

Super-intensive culture techniques offer two main advantages compared to pond production techniques. Firstly, there is no restriction with regard to production site or time: the culture procedure not requiring high saline waters nor specific climatological conditions. Secondly, the controlled production can be performed with very high densities of brine shrimp, up to several thousand animals per liter *versus* a maximum of a few hundred animals per litre in outdoor culture ponds. As a consequence, very high production yields per volume of culture medium can be obtained with tank-based rearing systems.

In the last decade several super-intensive *Artemia* farms have been established, including the USA, France, UK and Australia, so as to supply local demands. Depending on the selected culture technology and site facilities, production costs are estimated to be 2.5 to 12 US\$.kg⁻¹ live weight *Artemia* with wholesale prices varying from \$25 to \$100.kg⁻¹.

In practice, when setting up an *Artemia* culture one should start by making an inventory of prevailing culture conditions and available infrastructure.

The abiotic and biotic conditions relevant for *Artemia* culture are:

- physico-chemical culture conditions
 - ionic composition of the culture media
 - temperature
 - salinity
 - pH
 - oxygen concentration
 - illumination
 - water quality
- *Artemia*
 - strain selection
 - culture density
- feeding
 - feeding strategy
 - selection of suitable diets
- infrastructure
 - tank and aeration design
 - filter design
 - recirculation unit
 - heating
 - feeding apparatus
- culture techniques
 - open flow-through system
 - recirculation type
 - stagnant culture

4.4.2.2. Physico-chemical conditions

SALINITY AND IONIC COMPOSITION OF THE CULTURE MEDIA

Although *Artemia* in its natural environment is only occurring in high-salinity waters (mostly above 100 g.l⁻¹), brine shrimp do thrive in natural seawater. In fact, as outlined earlier (see under 4.1.), the lower limit of salinity at which they are found in nature is defined by the upper limit of salinity tolerance of local predators. Nonetheless their best physiological performance, in terms of growth rate and food conversion efficiency is at much lower salinity levels, (i.e. from 32 g.l⁻¹ up to 65 g.l⁻¹).

For culturing *Artemia*, the use of natural seawater of 35 g.l⁻¹ is the most practical. Small adjustments of salinity can be carried out by adding brine or diluting with tap water free from

high levels of chlorine. However, one should avoid direct addition of sea salt to the culture so as to prevent that undissolved salt remains in the tanks, and should keep a stock of brine for raising the salinity as required.

Apart from natural seawater or diluted brine, several artificial media with different ionic compositions have been used with success in indoor installations for brine shrimp production. Although the production of artificial seawater is expensive and labour-intensive it may be cost-effective under specific conditions. Examples of the composition of such media are given in Table 4.4.3. In some instances, the growth of *Artemia* is even better in these culture media than in natural seawater. Furthermore, it is not even essential to use complex formulas since 'Dietrich and Kalle' (a media prepared with only ten technical salts) have proved to be as good as complete artificial formulas.

Moreover, culture tests with GSL *Artemia* in modified ARC seawater (Table 4.4.3.) showed that KCl can be eliminated, and $MgCl_2$ and $MgSO_4$ can be reduced without affecting production characteristics. Calcium concentrations higher than 20 ppm are essential for chloride-habitat *Artemia* populations whereas carbonate-habitat strains prefer Ca^{2+} concentrations lower than 10 ppm in combination with low levels of Mg^{2+} .

Since ionic composition is so important, concentrated brine (not higher than 150 g.l⁻¹) from salinas can also be transported to the culture facilities and diluted with fresh water prior to its use.

TEMPERATURE, pH, AND OXYGEN CONCENTRATION

For most strains a common range of preference is 19-25°C (see also Table 4.4.4.). It follows that temperature must be maintained between the specific optimal levels of the selected *Artemia* strain. Several methods for heating seawater are discussed below (4.4.2.4 Heating).

According to published information, it is generally accepted that the pH tolerance for *Artemia* ranges from 6.5 to 8. The pH tends to decrease during the culture period as a result of denitrification processes. However, when the pH falls below 7.5 small amounts of $NaHCO_3$ (technical grade) should be added in order to increase the buffer capacity of the culture water. The pH is commonly measured using a calibrated electrode or with simple analytic lab kits. In the latter case read the instructions carefully in order to make sure whether the employed reaction is compatible with seawater.

With regard to oxygen, only very low concentrations of less than 2 mg O₂.l⁻¹ will limit the production of biomass. For optimal production, however, O₂-concentrations higher than 2.5 mg.l⁻¹ are suggested. Maintaining oxygen levels continuously higher than 5 mg.l⁻¹, on the other hand, will result in the production of pale animals (low in the respiratory pigment: haemoglobin), possibly with a lower individual dry weight, which may therefore be less perceptible and attractive for the predators.

Table 4.4.3. Artificial seawater formulations used for tank production of *Artemia* (in g.l⁻¹). For the Dietrich and Kalle formulation, solutions A and B are prepared separately, then mixed and strongly aerated for 24h.

Dietrich and Kalle		Instant Ocean		ARC	
Solution A					
NaCl	23.9	Cl ⁻	18.4	NaCl	31.08
MgCl ₂ .6H ₂ O	10.83	Na ⁺	10.22	MgCl ₂	6.09
CaCl ₂ anhydric	1.15	SO ₄ ²⁻	2.516	CaCl ₂	1.53
SrCl ₂ .6H ₂ O	0.004	Mg ²⁺	1.238	KCl	0.97
KCl	0.682	K ⁺	0.39	MgSO ₄	7.74
KBr	0.099	Ca ²⁺	0.37	NaHCO ₃	1.80
		HCO ₃ ⁻	0.142		
H ₂ O	856	H ₂ O	1000	H ₂ O	1000
Solution B					
NaSO ₄ .10H ₂ O	9.06				
NaHCO ₃	0.02				
NaF	0.0003				
H ₃ BO ₃	0.0027				
H ₂ O distilled	1000				

Table 4.4.4. The effect of temperature on different production parameters for various geographical strains of *Artemia* (data compiled from Vanhaecke and Sorgeloos, 1989)

Geographical strain	Temperature (°C)					
	20	22.5	25	27.5	30	32.5
San Francisco Bay, California, USA						
Survival (%)	97	97	94	91	66	n.a.
Biomass production ^a (%)	75	101	100	94	88	n.a.
Specific growth rate ^b	0.431	0.464 ^d	0.463 ^{d,e}	0.456 ^e	0.448 ^f	n.a.
Food conversion ^c	3.89	3.35 ^d	3.64 ^e	3.87 ^e	4.15 ^f	n.a.
Great Salt Lake, Utah, USA						
Survival (%)	77	85	89	89	87	88
Biomass production ^a (%)	69	104	122	128	135	78
Specific growth rate ^b	0.392 ^b	0.437 ^f	0.454 ^e	0.460 ^{d,e}	0.465 ^d	0.406 ^f
Food conversion ^c	3.79 ^f	2.90 ^e	2.65 ^{d,e}	2.62 ^d	2.40 ^d	4.14 ^g
Chaplin Lake, Saskatchewan, Canada						
Survival (%)	72	75	77	65	50	n.a.
Biomass production ^a (%)	78	102	108	106	90	n.a.
Specific growth rate ^b	0.422 ^f	0.452 ^{d,e}	0.459 ^d	0.456 ^d	0.437 ^e	n.a.
Food conversion ^c	3.42 ^e	3.00 ^d	3.03 ^d	3.11 ^d	3.72 ^d	n.a.
Tanggu, PR China						
Survival (%)	95	94	91	93	84	54
Biomass production ^a (%)	41	61	80	92	85	16
Specific growth rate ^b	0.299 ^f	0.343 ^e	0.371 ^d	0.387 ^d	0.378 ^d	0.208 ^f
Food conversion ^c	7.22 ^f	5.42 ^e	4.46 ^{d,e}	3.84 ^d	4.22 ^{d,e}	22.4 ^f

^a: expressed as % recorded for the *Artemia* reference strain (San Francisco Bay, batch 288-2596) at 25C after 9 days culturing on a diet of *Dunaliella* cells

^b: specific growth rate $k = \ln(W_t - W_0) \cdot T^{-1}$ where T = duration of experiment in days (=9)

W_t = μg dry weight *Artemia* biomass after 9 days culturing

W_0 = μg dry weight *Artemia* biomass at start of experiment

^c: food conversion = $F \cdot (W_t - W_0)$

where F = μg dry weight *Dunaliella* offered as food

^{d to g}: means with the same superscript are not significantly different at the $P < 0.05$ level

n.a.: not analyzed

A dark red colouration (high haemoglobin content) is easily obtained by applying regular but short (few minutes) oxygen stresses (by switching off the aeration) a few days before harvesting. Oxygen levels should be checked regularly as they may drop significantly, especially after feeding. Oxygen is conveniently measured with a portable oxygen electrode. When oxygen occasionally drops below 30% saturation (i.e. 2.5 mg O₂.l⁻¹ in seawater of 32 g.l⁻¹ salinity at 27°C), aeration intensity should be increased temporarily or air stones added. If oxygen levels remain low, the aeration capacity should be increased. Remember that for a given air flow, the oxygen level is more effectively increased by small air bubbles compared to big ones. Too small air bubbles, on the other hand, may get trapped between the thoracopods and skim off the animals to the surface.

WATER QUALITY

The quality of the culture medium is first affected by excess particles as well as by soluble waste products such as nitrogen compounds.

High levels of suspended solids will affect production characteristics, either by their interference with uptake of food particles and propulsion by *Artemia*, or by inducing bacterial growth that will compete for oxygen and eventually infest the culture tank. Harmful particle levels are not determined since no practical method for their measurement has been developed. However, problems caused by excess particles can be detected through the microscopic observation of the animals: thoracopods should be unclogged, and the gut should be uniformly filled and unobstructed. With some experience, acceptable particle load can be estimated on sight by holding up an aliquot of the culture in a transparent beaker against a light source.

Soluble waste products give rise to toxic nitrogen-compounds (e.g. NH₃-N, NO₂⁻-N, NO₃⁻-N). Levels of nitrogen components can be measured with appropriate lab kits (make sure to use seawater adapted versions). The tolerance levels in *Artemia* for ammonia, respectively nitrite and nitrate in acute and chronic toxicity tests with, for instance, GSL brine shrimp larvae showed no significant effect on survival (LC₅₀) nor growth for concentrations up to 1000 mg.l⁻¹ NH₄⁺, respectively 320 mg.l⁻¹ NO₂⁻-N. It is therefore very unlikely that N-components will interfere directly with the *Artemia* cultures. Nevertheless the presence of soluble substances should be restricted as much as possible since they are an ideal substrate for bacteria. Excess soluble waste products can only be eliminated by diluting the culture water with clean water, be it new or recycled. Methods to evacuate loaded culture water are discussed below.

4.4.2.3. *Artemia*

STRAIN SELECTION

Based on laboratory results (Table 4.4.4.), guidelines are provided for strain selection as a function of optimal temperature and culture performance. The most suitable strain should be selected according to local culture conditions, such as temperature range, ionic composition of culture water, etc ...

CULTURE DENSITY OF *ARTEMIA*

Unlike other crustaceans, *Artemia* can be cultured at high to very high densities without affecting survival. Depending on the applied culture technique, inoculation densities up to 5,000 larvae per litre for batch culture, 10,000 for closed flow-through culture, and 18,000 for open flow-through culture can be maintained without interference on survival (Table 4.4.5.). Maximum densities cause no real interference on behaviour. Of course, each culture has its maximum carrying capacity: above these densities, culture conditions become suboptimal (water quality deterioration, lower individual food availability) and growth and survival decrease (see also Table 4.4.9.).

In contrast to survival, crowding seems to affect ingestion rate and therefore growth. In stagnant systems, a clear decrease of the growth rate with increasing animal density was observed, since the preservation of the water quality compels us to a relatively lower individual feeding rate at high animal densities.

The cost-effectiveness of a culture obviously increases with increasing *Artemia* density. In an open flow-through system, maximal densities will be limited by feeding rate while in recirculating and stagnant system the preservation of water quality will determine a safe feeding level, which in turn determines the animal density at which the individual feed amount still allows a satisfactory growth rate.

A first approach to a maximal animal density can be based on data reported with different culture technologies. (Table 4.4.5.)

Culture system	<i>Artemia</i> .l ⁻¹	Culture period	Growth	Reference
open flow-through	18,000	to adult	high	Tobias <i>et al.</i> ,1980
closed flow-through	>10,000	to adult	moderate	Lavens <i>et al.</i> ,1986
	5,000 - 10,000	to adult	high	
stagnant	5,000	7 days	high	Dhont <i>et al.</i> ,1993
	20,000	7 days	low	

After some culture trials with increasing animal densities, the maximal density can be identified as the highest possible density where no growth inhibition occurs.

4.4.2.4. Feeding

Artemia is a continuous, non-selective, particle-filtration feeder. Various factors may influence the feeding behavior of *Artemia* by affecting the filtration rate, ingestion rate and/or assimilation: including the quality and quantity of the food offered, the developmental stage of the larvae, and the culture conditions. More detailed information concerning these processes are given in Coutteau & Sorgeloos (1989).

SELECTION OF A SUITABLE DIET

Artemia can take up and digest exogenous microflora as part of the diet. Bacteria and protozoans which develop easily in the *Artemia* cultures are able to biosynthesize essential nutrients as they use the supplied brine shrimp food as a substrate; in this way they compensate for any possible deficiencies in the diet's composition.

The interference by bacteria makes it a hard task to identify nutritionally adequate diets as such, since growth tests are difficult to run under axenic conditions. As a consequence the nutritional composition of the diet does not play the most critical role in the selection of diets suitable for high density culture of brine shrimp. Other more important criteria include:

- availability and cost
- particle size composition (preferentially <50µm)
- digestibility
- consistency in composition among different batches and storage capacity
- solubility (minimal)
- food conversion efficiency (FCE)
- buoyancy

Commonly used food sources include:

Micro-algae: undoubtedly yield best culture results but rarely available in sufficient amounts at a reasonable cost. As such the mass culture of suitable algae for *Artemia* is not economically realistic, so their use can only be considered in those places where the algal production is an additional feature of the main activity. Moreover, not all species of unicellular algae are considered suitable for sustaining *Artemia* growth (d'Agostino, 1980). For example, *Chlorella* and *Stichococcus* have a thick cell wall that cannot be digested by *Artemia*, *Coccochloris* produces gelatinous substances that interfere with food uptake, and some dinoflagellates produce toxic substances.

Normally, a constant supply of a rather concentrated algal effluent is required to sustain an intensive *Artemia* culture. At low algal concentrations, either *Artemia* density must be lowered thus reducing productivity, or the flow rate must be high and thus increasing pumping and heating costs.

If a suitable algal supply exists, it is most conveniently applied in an open flow-through system. Flow rates are monitored as to maintain optimal feed levels in the culture tank (see further: Feeding Strategy). Tobias *et al.* (1980) suggested a 2-phase culture on algal effluents, based on the increase in filter efficiency of *Artemia* synchronous with its development. In the first part of this cascade system, juvenile *Artemia* are grown at a very high density on the concentrated effluent. The culture water effluent, that is still containing algae but at a lower concentration, is directed to a second culture tank where adult *Artemia*, stocked at lower densities, are able to remove the algae remains.

Dried algae: in most cases algal meals give satisfactory growth performance, especially when water quality conditions are kept optimal. Drawbacks in the use of these feeds are their high cost (>12 US \$.kg⁻¹), as well as their high fraction of water soluble components which cannot be ingested by the brine shrimp but which interfere with the water quality of the culture medium.

Bacteria and yeasts: Single-Cell Proteins (SCP) have several characteristics which make them an interesting alternative for micro-algae:

- the cell diameter is mostly smaller than 20 µm
- the nutritional composition is fairly complete
- the rigid cell walls prevent the leakage of water-soluble nutrients in the culture medium
- products are commercially available at acceptable cost (e.g., commonly used in cattle feeds)

The highly variable production yields, which often occur when feeding a yeast mono-diet, are usually due to the nutritional deficiencies of the yeast diet and should therefore be compensated by supplementation with other ingredient sources.

For certain SCP, digestibility by the *Artemia* can also be a problem. For example, the complete removal of the complex and thick yeast cell wall by enzymatic treatment and/or supplementation of the diet with live algae significantly improved assimilation rate and growth rate of the brine shrimp (Coutteau *et al.*, 1992).

Waste products from the food industry: non-soluble waste products from agricultural crops or from the food-processing industry (e.g. rice bran, corn bran, soybean pellets, lactoserum) appear to be a very suitable feed source for the high-density culture of *Artemia* (Dobbeleir *et al.*, 1980). The main advantages of these products are their low cost and universal global availability. Equally important in the evaluation of dry food is the consistency of the food quality and supply, and the possibility for storage without loss of quality. It follows therefore that bulk products must be stored in a dry and preferentially cool place.

In most cases, commercially available feeds do not meet the particle size requirements and further treatment is needed. When man-power is cheap a manual preparation can be used to obtain feed particles in the 50-60 µm size range. It consists of a wet homogenization in seawater (using an electrical blender) followed by the squeezing of the suspension through a 50 µm filter bag. Since the feed suspension obtained cannot be stored, this manual method can only be used on a day-to-day basis for feed processing. Furthermore, this manual processing method is not very effective with products high in fibre such as e.g. rice bran, where as much as 90% of the product may be discarded.

In order to reduce the manual labour required in preparing the food, mechanical techniques for dry grinding and processing need to be used. In several cases, sophisticated and therefore expensive equipment is required, (i.e. micronisation grinding) which restricts its practical use and cost-effectiveness.

Soluble material is not taken up by *Artemia* and will be decomposed in the culture medium by bacteria, thereby deteriorating water quality via a gradual build up of toxic substances such as ammonia and nitrite. Hence feeds which contain high amounts of soluble proteins (e.g. soybean meal) should be treated prior to their use in order to reduce the soluble fraction. This can easily be achieved by strongly aerating the feed suspension with airstones for 1-2 h and then allowing the feed particles to settle by cutting off the aeration for another half an hour. Dissolved materials will foam off or remain in the water fraction which can be drained off from the sedimented particles. This washing procedure can be repeated until most soluble matter is removed.

FEEDING STRATEGY

Since *Artemia* is a continuous filter-feeding organism, highest growth and minimal deposition of unconsumed food is achieved when food is distributed as frequently as possible.

When feeding **Single-Cell Proteins**, algal or yeast concentrations should be maintained above the critical minimum uptake concentration which is specific for the algal species and the developmental stage of *Artemia* (Abreu-Grobois *et al.*, 1991). Using baker's yeast, Coutteau & Sorgeloos (1989) observed a severe decrease of the limiting uptake level from 500 cells/ μ l for 2-day old *Artemia* to 100 cells/ μ l for *Artemia* older than one week. Conversion to *Dunaliella* cells can be obtained using a commonly accepted ratio of 3 yeast cells per *Dunaliella* cell. Although nutritional properties seem to affect the ingestion process, a fair approximation of minimal concentrations of other algae species can be extrapolated using simple volumetric ratios.

Since *Artemia* has a high clearance rate of micro-algae, the algal concentration in the culture tank should be determined several times a day and the retention time adjusted so as to maintain levels well above the estimated minimal uptake concentration. If you have no data on ingestion rate or optimal feed levels, you can try out different algal concentrations and estimate feeding level by microscopical observation. Well-fed animals have a completely filled gut and release compact faecal pellets. Underfed animals have an empty or barely filled gut and tend to release loose faecal pellets.

Levels of **dry feeds**, consisting of fragments and irregular particles, cannot be counted in the culture tank. Therefore a correlation between optimal feed level and transparency of the culture water has been developed: the feed concentration in a culture tank is commonly determined by measuring the transparency of the water with a simplified Secchi-disc (see Fig. 4.4.1.). The turbidistick is slowly submerged in the water until the contrast between the dark and light areas has disappeared. The transparency is read as the depth of submersion of the stick (in cm). This measurement is evidently subject to some individual variance. If several people are involved in the maintenance of the culture, some prior harmonization of the reading of the turbidistick is recommended.

Experience learned that optimal feed levels coincide with transparencies of 15 to 20 cm during the first culture week and 20 to 25 cm the following week (Lavens *et al.*, 1986). Once animals reach the adult stage, best production yields are obtained when gradually switching from a transparency-controlled food distribution to a feeding scheme of about 10% dry feed weight of the live weight *Artemia* per litre per day (Lavens & Sorgeloos, 1987). A feeding scheme is given in worksheet 4.4.1.

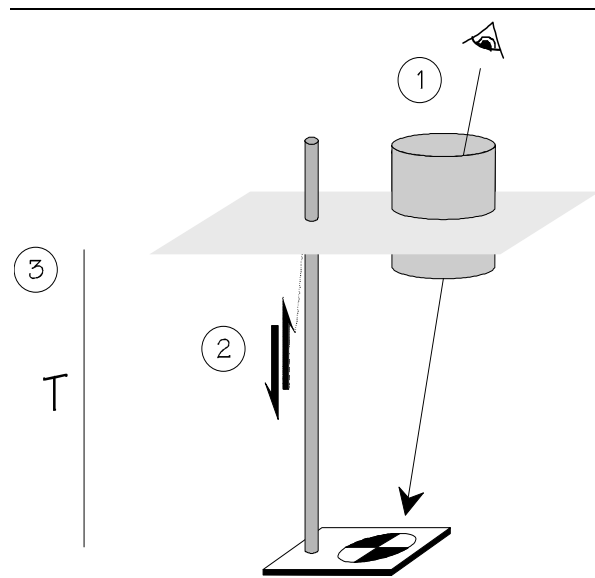

Figure 4.4.1. Feeding strategy with dry food. 1. Look through looking glass to turbidistick 2. Submerge turbidistick until contrast between black and white disappear. 3. Read depth of submergence in centimeter (=T).

4.4.2.5. Infrastructure

TANK AND AERATION DESIGN

Artemia can be reared in containers of any possible shape as long as the installed aeration ensures proper oxygenation and adequate mixing of feed and animals throughout the total culture volume. However, aeration should not be too strong. Thus, aeration and tank design must be considered together as the circulation pattern is determined by the combination of both. A wide variety of different culture tanks has proven to be suitable.

For cultures up to 1 m³, rectangular tanks are the most convenient. They can be aerated either with an air-water-lift (AWL, see Fig. 4.4.2.) system (Fig. 4.4.3), by an aeration collar mounted around a central standpipe (Fig. 4.4.4), or by perforated PVC tubes fixed to the bottom of the tank. For larger volumes (>1 m³), it is advantageous to switch to cement tanks lined on the inside with impermeable plastic sheets or coated with special paint. These large tanks are traditionally operated as raceway systems. They are oblong, approximately 1.5 m wide and with a height/width ratio kept close to 1:2 (see Fig. 4.4.3.). The length is then chosen according to the desired volume. The corners of the tank may be curved to prevent dead zones where sedimentation can take place. A central partition, to which AWL's are fixed, is installed in the middle of the tank and assures a combined horizontal and vertical movement of the water which results in a screw-like flow pattern (Bossuyt and Sorgeloos, 1980). If axial blowers are used for aeration, the water depth should not exceed 1.2 m to assure optimal water circulation.

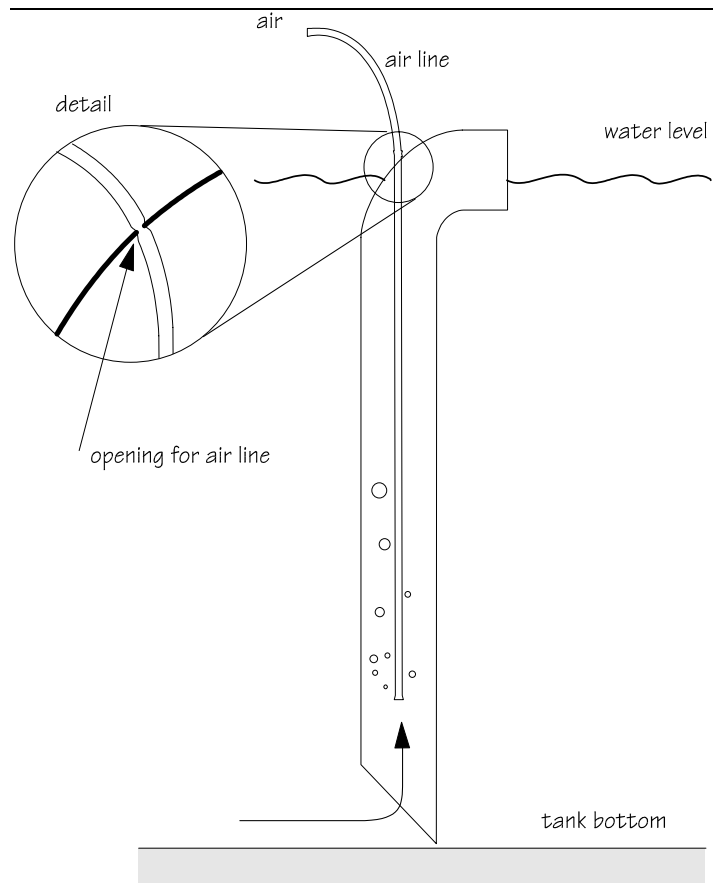

Figure 4.4.2. Detail of an air-water-lift.

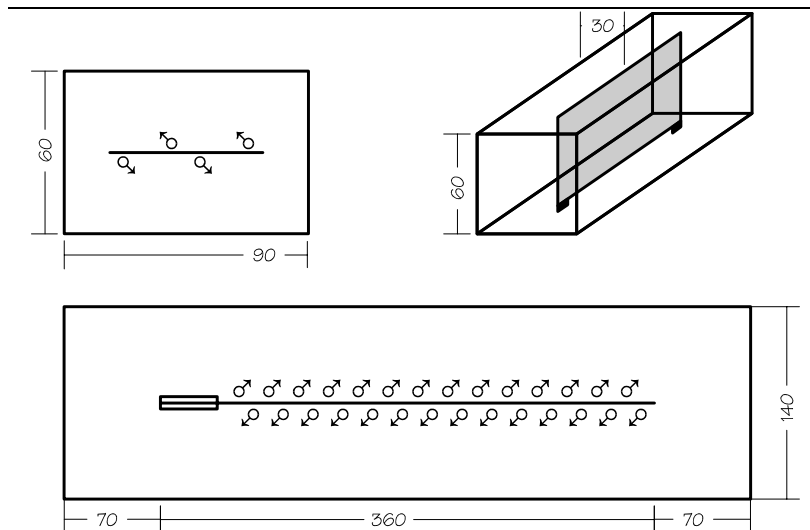

Figure 4.4.3. Schematic views and dimensions (in cm) of raceway systems for *Artemia* culturing (modified from Bossuyt and Sorgeloos, 1980).

♂: AWL

Top left : 300 l tank: diameter AWL 4 cm, ± 7 l air./min⁻¹.AWL⁻¹
 Bottom and top right: 5 m³ tank 80 cm depth, diameter AWL 5 cm, ± 10 l air. min⁻¹.AWL⁻¹

FILTER DESIGN

The most important and critical equipment in flow-through culturing is the filter used for efficient evacuation of excess culture water and metabolites without losing the brine shrimp from the culture tank. These filter units should be able to operate without clogging for at least 24 h in order to reduce risks of overflowing.

Initially, filters were constructed as a PVC-frame around which an interchangeable nylon screen was fixed. The aeration was positioned at the bottom of the filter and ensured a continuous friction of air bubbles against the sides of the filter screen, which resulted in an efficient reduction of filter-mesh clogging (see Fig. 4.4.4.).

The upper part of the filter bag positioned just above and underneath the water level was made of smooth nylon cloth or plastic as to prevent any trapping of the brine shrimp that are foamed off by the effect of the aeration collar. Later, a new type of cylindrical filter system (Fig. 4.4.5.) was introduced. It consists of a welded-wedge screen cylinder, made of stainless steel, that is vertically placed in the center of the culture tank (Fig. 4.4.6.). The base is closed by a PVC-ring and bears a flexible tube for the evacuation of the effluent. An aeration collar is fixed to the lower end of the filter.

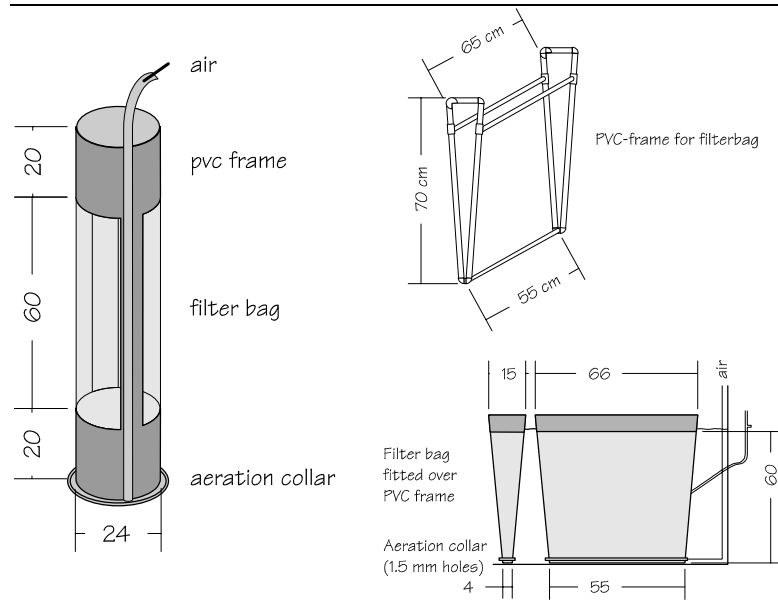

Figure 4.4.4. Schematic views and dimensions of filter systems used in flow-through culturing of *Artemia* (modified from Brisset *et al.*, 1982).

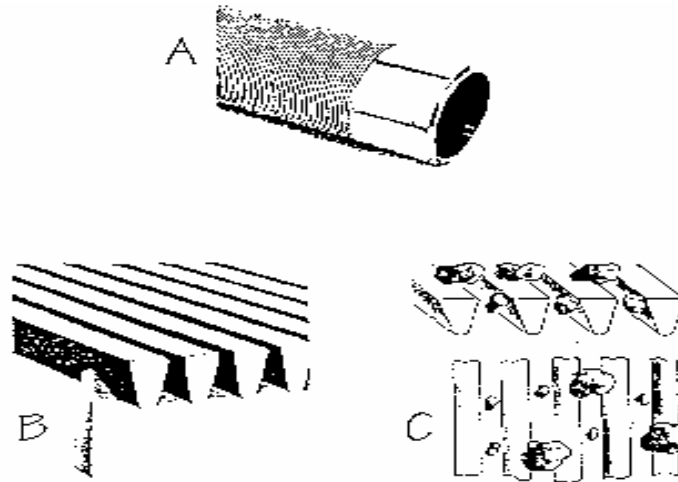

Figure 4.4.5. Filter system based on welded wedge-screen : (A) stainless steel welded-wedge cylinder (B) detail of welded wedge screen (C) schematic illustration of filter functioning

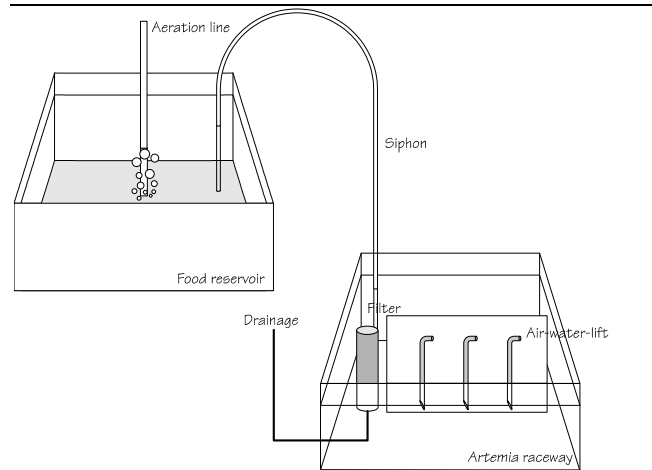

Figure 4.4.6. Schematic view of a 1000 l open flow-through system (modified from Dhert *et al*, 1992).

This welded-wedge system has several advantages in comparison to the nylon mesh types:

- oversized particles with an elongated shape can still be evacuated through the slit openings (Fig.4.4.5.C),
- the specially designed V-shape of the slit-openings creates specific hydrodynamic suction effects as a result of which particles that are hardly slightly smaller than the slit-opening are actively sucked through,
- possible contact points between particles and filter are reduced to two instead of four mesh borders, which consequently reduces clogging probability.

This filter can be operated autonomously for much longer periods than traditional nylon mesh-filters. Therefore, proportionally smaller welded-wedge filters can be used, leaving more volume for the animals in the culture tank. Furthermore, they are cost-effective since they do not wear out.

As brine shrimp grow, the filter is regularly switched for one with a larger mesh- or slit-openings in order to achieve a maximal evacuation of molts, faeces and other waste particles from the culture tanks. Before changing to a larger mesh check whether animals can cross the larger mesh. If so it is still too early and the actual filter is returned after cleaning. A set of filters covering a 14-day culture period should consist of approximately six different slit/mesh-openings ranging from 120 μm to 550 μm (Table 4.4.6.).

Table 4.4.6. Example of food and water renewal management in a 300 l super-intensive *Artemia* culture (data compiled from Lavens & Sorgeloos, 1991).

Culture day	Slit opening of filter (μm)	Flow rate (l/h)	Retention time in culture tank (h)	Interval between feeding (min)	Daily food amount (g)
1	120	80	3.75	36	100
2	150	100	3	30	120
3-4	200	100	3	24	150
5-7	250	150	2	20	180
8-9	300	150	2	20	180
10-12	350	200	1.5	15	250
13-14	350	300	1	12	300

If the water circulation in the culture tank is correct, the filter may be positioned anywhere in the tank. In cylindrical tanks, especially with conical bottoms, the filter is ideally placed in the center.

HEATING

When ambient temperature is below optimal culture values (25-28°C), heating is imperative. Small volumes (<1 m³) are most conveniently heated using electric thermo-regulated resistors. Depending on the ambient temperature a capacity up to 1000 W.m⁻³ must be provided. For larger volumes, a heat exchanger consisting of a thermostatic-controlled boiler with copper tubing under or on the bottom of the culture tank is recommended. Heat losses can be avoided by insulating the tanks with styrofoam and covering the surface with plastic sheets.

FEED DISTRIBUTION APPARATUS

Dry feeds can not be distributed as such to the culture tank, and therefore need to be mixed in tap or seawater beforehand. The feed suspension is distributed to the culture tanks via a timer-controlled pump (Fig.4.4.7.).

The volume of the food tank should be large enough to hold the highest daily food ration at a maximum concentration of $200 \text{ g food.l}^{-1}$. Even at these concentrations, the food suspension is so thick that the risk for clogging of the food lines is quite high. It follows therefore that care must be taken that the lowest point of the feed lines is beyond the pump so that food that settles during intervals between feeding does not need to pass through the pump when activated. If some distance exists between the pump and the culture tank an air-inlet just behind the pump will continually blow all food out of the feed lines, towards the culture tank.

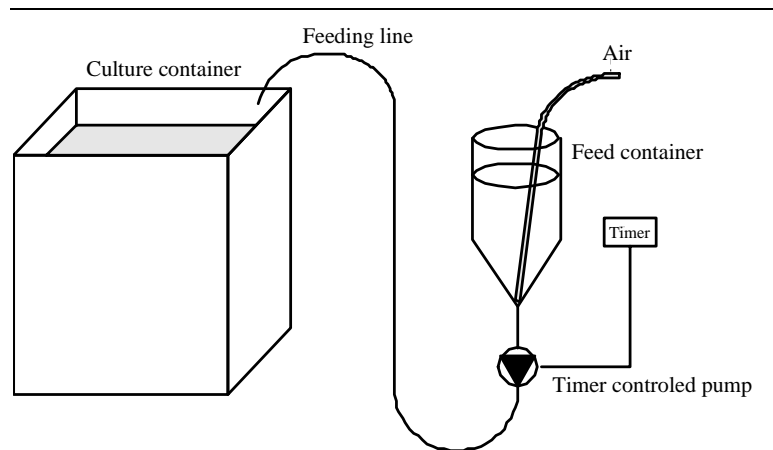

Figure 4.4.7. Automatic food distribution

4.4.2.6. Culture techniques

Depending upon the objectives and the opportunities, different culture procedures for super-intensive *Artemia* production may be applied. The final selection of one or other type of installation will be subject to local conditions, production needs and investment possibilities. However, two basic options are: should water be renewed (open flow-through) or not. Furthermore, in the latter case, should a particular water treatment be applied (closed flow-through) or not (stagnant or batch system). Obviously there are all kinds of transition types ranging from open flow-through with 0% recirculation to closed flow-through with 100% recirculation. In reality, even at complete recirculation, a small part of the culture water must be regularly renewed.

The culture system should be designed in such a way that the water quality can be maintained as optimal as possible. This means that the concentration of particles and soluble metabolites should remain minimal as to prevent toxicity problems, proliferation of micro-organisms and interferences with the filter-feeding apparatus of the brine shrimp.

OPEN FLOW-THROUGH

It is obvious that a discontinuous or continuous renewal of culture water by clean seawater, with consequent dilution of particulate and dissolved metabolites, will result in the best possible culture conditions and highest production capacities. Application of an open flow-through culture technique, however, is limited to those situations where large volumes of sufficiently warm seawater (or brine) are available at relatively low cost or where large quantities of algal food are available, (i.e. effluents from artificial upwelling projects, tertiary treatment systems, intensive shrimp grow-out ponds etc.). If such a condition is not fulfilled, partial recirculation through a water treatment unit is indispensable (see further).

The effluent filter forms a crucial component as described previously. The water retention time is chosen so as to reach an optimal compromise between efficient evacuation of waste water and minimal food losses. An optimal flow-rate regime applied for a 300 l rectangular tank equipped with welded-wedge filters (65 cm high by 14 cm in diameter) is outlined in Table 4.4.6. The adjustment of the flow rate can be accomplished by using interchangeable PVC-caps which fit onto the PVC water supply pipe connected to a constant head tower. When calibrated, a series of caps with increasing number of perforations enables the operator to maintain a pre-set flow rate; this has proven to be much more practical than adjusting the valves.

A very simple semi flow-through system has been developed by Dhert *et al.* (1992). The system does not require the use of feeding pumps and involves minimal care. The pilot system consists of six oval raceway tanks of 1 m³ (see above) and six reservoir tanks of the same capacity placed above each culture tank (Fig. 4.4.6.). Those reservoir tanks hold seawater and food (squeezed rice bran suspension), and need manual refilling only once or twice a day. They are slowly drained to the culture tanks. Flow rate is easily adjusted by means of a siphon of a selected diameter. Retention time is at least 12 h. The culture effluent is drained using welded-wedge filters as described above. This technique involves minimal sophistication and appears to be very predictable in production yields which are between those obtained in batch and flow-through systems (see 4.4.2.9. Production figures).

CLOSED FLOW-THROUGH SYSTEMS

When only limited quantities of warm seawater are available, open flow-through systems cannot be considered. Yet, if one decides to culture at high animal densities and/or for prolonged culture periods, the accumulation of particles and soluble metabolites will reduce the water quality until good culture practices become impossible. Under these conditions, the high-density flow-through culturing of *Artemia* can be maintained only by recirculating the culture water over a water treatment unit. This unit should be designed to remove particles and decrease levels of harmful nitrogen components.

Even though there have been significant research efforts to develop performing recirculation systems, the operation of practical recirculating systems for *Artemia* is still more an art than a science. That is why we will not recommend one specific recirculation technology. Figure 4.4.8. should therefore be considered as one example of an operational recirculating system for *Artemia* culture, as was developed at the Artemia Reference Center.

The effluent is drained from the culture tanks using filters described above. Largest flocks are removed from the effluent in a small decantation tank. The effluent is then treated in a rotating biological contactor. In this rotating biological contactor (RBC) or 'biodisc', nitrogen compounds from soluble organic products are broken down via oxidative deamination and

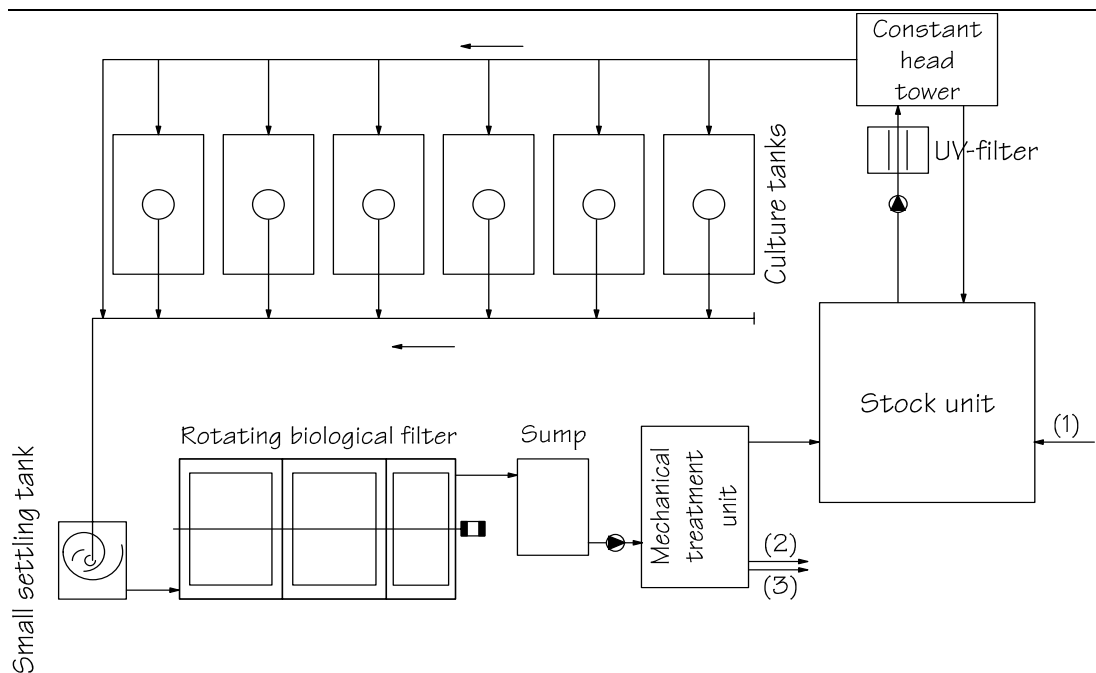

Figure 4.4.8. Schematic diagram of a closed flow-through system for culturing *Artemia*. (1) fresh seawater addition; (2) drain of water and of (3) suspended solids (modified from Lavens *et al.*, 1986).

The biodisc effluent is pumped over a cross-flow sieve (200 cm^2) with a slit-opening of $150 \mu\text{m}$ (Fig. 4.4.9.). The effluent cascades over the inclined sieve at high speed, pushing particles and flocks downwards while an important part of the water is evacuated through the sieve. The use of a well designed cross-flow sieve can drastically reduce the volume of the effluent (up to 50%) calling for much smaller dimensions of the subsequent plate separator.

The concentrated sludge is subsequently drained to a plate separator (Fig. 4.4.10.), while water collected through the cross-flow sieve is directly returned to the reservoir. In this way the volume of the plate separator could be reduced to 650 l. It consists of an inclined tank subdivided into a small inflow and a large settling compartment where parallel sand blasted or corrugated PVC-plates are mounted in an inclined position (60°).

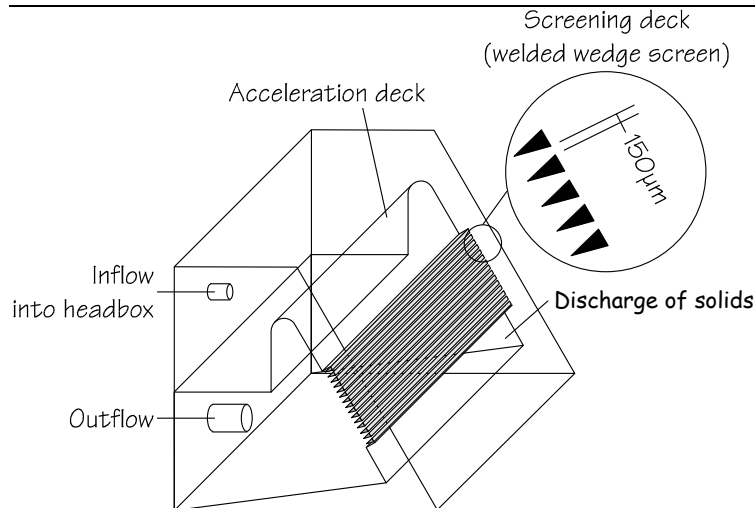

Figure 4.4.9. Cross-flow sieve system for concentrating suspended particles from *Artemia* culture effluent (modified from Bossuyt and Sorgeloos, 1980).

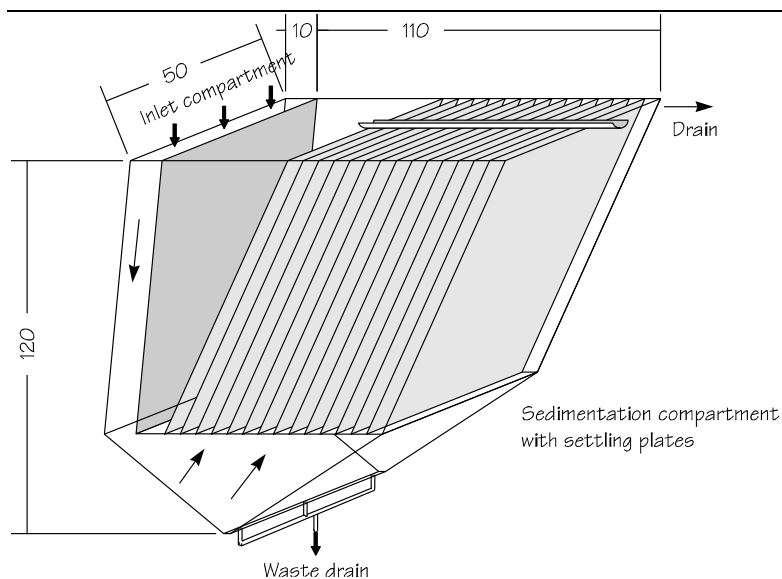

Figure 4.4.10. Schematic view and dimension (cm) of a plate separator (650 l) used for primary treatment of a 2 m³ *Artemia* raceway (modified from Sorgeloos *et al.*, 1986).

In the settling compartment the effluent rises slowly enough to enable particles to settle on the plates. A drain fixed on top of the plates finally evacuates the clean water to the stock tank. Optimal retention times of 20 minutes assure maximal sedimentation of the waste particles. Once every 2 to 3 days recirculation is interrupted and the plates vigorously shaken. The accumulated sludge should be drained by siphoning from the bottom of the tank.

A last step in the purification process may be disinfection by U.V. radiation, but, there is no absolute proof of its effectiveness in the culture of *Artemia* nor does it result in a completely sterile medium. The treated water is pumped in a constant-head tower and returned to the culture tanks (Fig. 4.4.8.). At regular time intervals part of the water should be renewed. In our system we apply an arbitrarily chosen 25% water exchange on a weekly basis. Using this recirculation system for an *Artemia* culture unit of six 300 l tanks, water quality can be maintained at acceptable levels (i.e. the biological and mechanical treatments result in an effluent containing less than 5 mg.l⁻¹ TOC, which accounts for a removal percentage of more than 80%). The levels for NH₄⁺-N and NO₂⁻-N remain below 10.9 mg.l⁻¹ and 0.6 mg.l⁻¹, respectively, which is far below the tolerance limits for *Artemia*. Levels for suspended solids do not exceed 380 mg.l⁻¹ (Lavens & Sorgeloos, 1991).

When culturing at lower intensity (5 animals.ml⁻¹) or for shorter periods (14 days) a less complex treatment unit is required. As an example, a 2000 l, air-water-lift operated raceway has proven to be very serviceable. With the exception of the water exchange, the same culture conditions can be maintained as described for the flow-through system. However, automation is more difficult, and monitoring, especially with regard to feeding conditions, more critical. The first days of culture do not present any problem and optimal feeding levels can easily be maintained. From the fourth day onwards the water quality deteriorates quickly and waste particles e.g., faecal pellets, food aggregates, and exuviae, physically hamper food uptake by the *Artemia* and interfere with the transparency measurements. The solution is to install a primary treatment unit such as a plate separator (see above) connected to the raceway. This also implies the use of filters to retain the *Artemia* in the culture tanks. Clogging of these filters is less problematic here than in flow-through culturing since no extra water is added and there are no overflow risks. Flow rates and plate separator dimensions are a function of the volume of the raceway; optimal particle removal is assured when the medium passes over the plate separator at least eight times a day. Apart from the elimination of particulate wastes, it may also be desirable to partially remove the soluble fraction from the culture medium, especially when feeding products that are rich in proteins or which contain a high fraction of soluble material. An easy technique to incorporate in the batch culture design is foam fractioning. A schematic drawing of a foam tower for the final treatment of the effluent of a 2 m³ raceway is provided in Fig. 4.4.11.

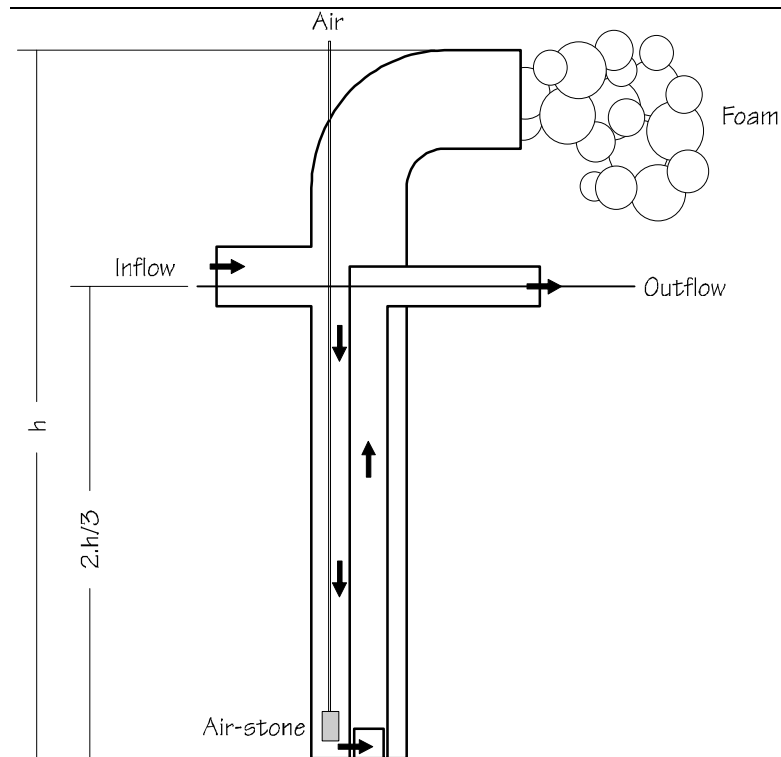

Figure 4.4.11. Schematic diagram of a foam separator (modified from Sorgeloos *et al.*, 1986).

STAGNANT SYSTEMS

Although the advantages of using preys with a gradual increasing size are fully recognized, the complexity and additional costs of growing *Artemia* as compared to nauplii may be in many cases prohibitive. Therefore, a simplified but reliable technique for the short-term intensive culture of *Artemia* juveniles for use as a nursery diet for fish and shrimp was developed at the ARC. The idea was to develop a flexible culture procedure, covering the production of *Artemia* of specific sizes up to 3 mm. Again their nutritional value can easily be improved through simple enrichment techniques. In fact, higher (n-3) HUFA levels are obtained than for nauplii enrichment.

Cultures were performed either in 100 l or in 500 l rectangular polyethylene tanks. Aeration is ensured by four perforated PVC tubes fixed to the bottom. Cysts are hatched, counted and transferred to the culture tanks at 5, 10, 15, 20 and 50 animals.ml⁻¹ depending on the desired growth rate (Figure 4.4.12.). The culture period is arbitrarily limited to 7 days. The animals are fed micronized soybean and pea. The feed is mixed daily in tap water and distributed semi-continuously to the culture. Daily feed ratios are chosen so as to keep the transparency of the culture water between 15 and 20 cm. A directive feeding regime was established (Table 4.4.7.) but, nevertheless, each culture requires constant adjustment of the ratios according to the prevailing transparency.

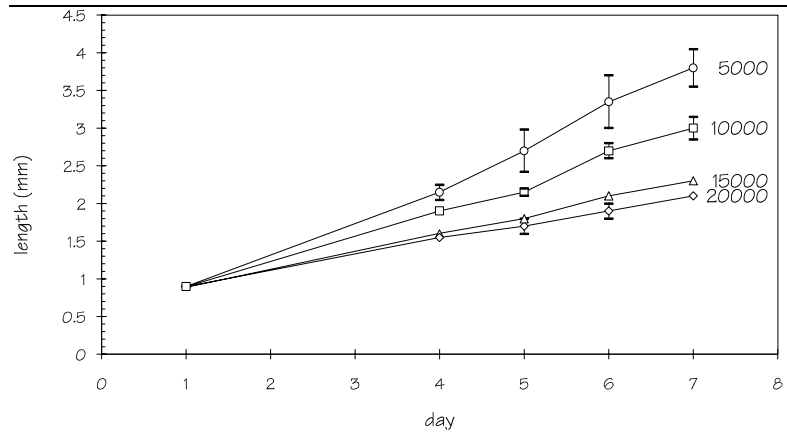

Figure 4.4.12. Growth curves of *Artemia* cultured under batch conditions : 5 animals.ml⁻¹ (o) , 10 animals. ml⁻¹ (G), 15 animals. ml⁻¹ (I) and 20 animals.ml⁻¹ (◇)(from Dhont *et al.*, 1993).

Table 4.4.7. Directive feeding regime with soybean and pea for a culture of 10 animals.ml⁻¹ (g.m⁻³ culture volume) and enrichment ratios added daily to the food suspension (mg DRY SELCO.l⁻¹ culture volume) (data compiled from Dhont *et al.*, 1993).

day	0	1	2	3	4	5	6	total
soybean & pea	200	225	250	300	325	350	350	2000
DRY SELCO	-	37.5	62.5	87.5	112.5	137.5	162.5	600

4.4.2.7. Enrichment of ongrown *Artemia*

Artemia juveniles can be enriched in the same way as nauplii (see above), but, due to the higher filtration efficiency, this results in higher (n-3) HUFA levels in much shorter enrichment periods (1- 4h) (Table 4.4.8.). It is furthermore assumed that these short enrichment periods may result in higher final DHA/EPA ratios in the biomass compared to nauplii when boosted with high-DHA emulsions, since there is insufficient time to break down the DHA as is the case in nauplii. There is however, an alternative method that takes profit of the specific aspects of ongrown *Artemia*: instead of adding the enrichment emulsion at the end of the culture, it is distributed during the culture. This way we take advantage of the feeding behaviour of brine shrimp. The essential fatty acids will not only be ingested but will be incorporated in the body tissue as well. Daily increasing doses of DRY SELCO (INVE Aquaculture NV, Belgium) are added to the food suspension so that total DRY SELCO ratio equalled 0.6 g.l⁻¹ (analogous to short term enrichment of nauplii) by the end of the culture (Table 4.4.7.). This method has several advantages: (n-3) HUFA levels can be five times higher than when the same amount is given in one ration after 7 days (Table 4.4.8.); the risk for acute oxygen drops is avoided and *Artemia* that are harvested before the end of the culture are already partially enriched.

Table 4.4.8. Comparison of enrichment results of *Artemia* juveniles and nauplii with 0.6 g Dry Selco.l⁻¹ (compiled from Dhont et al., 1993 and Léger et al., 1986)

<i>Artemia</i>	Procedure	Duration	20:5n-3 (mg.g ⁻¹ DW)	22:6n-3 (mg.g ⁻¹ DW)	n-3 HUFA (mg.g ⁻¹ DW)
nauplii	after hatching	12 h	7.9	4.4	14.4
juveniles	after culture	4 h	5.8	4.4	14.2
	during culture	7 days	44.2	16.5	64.3

4.4.2.8. Control of infections

Occasionally heavy losses of preadults are faced due to infections with filamentous *Leucothrix* bacteria which occur especially in nutrient-rich media. The *Leucothrix* colonies fix on the exoskeleton, by preference on the thoracopods, and become only visible from the instar V/VI-stage onwards. The brine shrimp suffer physically, as the movements of their thoracopods become affected and filtration rates consequently are reduced. Eventually, growth and molting are arrested, overfeeding of the tanks occurs, resulting in collapse of the *Artemia* culture.

A cure may be the application of terramycin, however, antibiotics cannot be used in recirculation systems as they will affect the biological treatment unit. The most practical solution appears to be a raise in salinity from 35 to 50-60 g.l⁻¹ together with a higher water renewal rate.

A second observed disease in *Artemia* cultures is the so-called 'black disease'; where part of the animals show black spots especially at their extremities, (i.e. thoracopods, antennae (Fig. 4.4.13). This disease consists of the detachment of the epidermis from the cuticula, and is caused by a dietary deficiency which interferes with lipid metabolism. In high density culturing of *Artemia* using agricultural by-products as a food source, the black disease is observed when water quality deteriorates (probably interfering with the composition of the bacterial population and consequently the diet composition) and/or when feeding rates are not optimal. Improving these conditions does not save the affected animals but appears to avoid further losses.

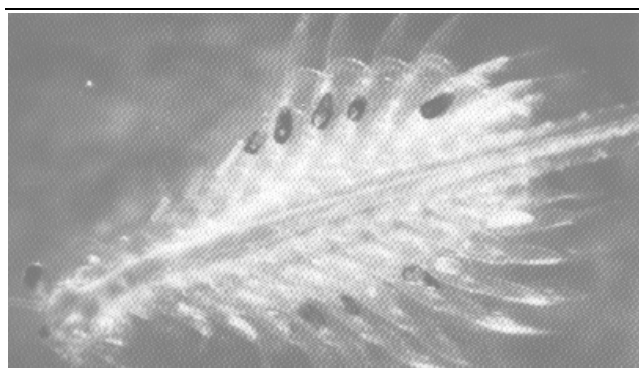

Figure 4.4.13. *Artemia* showing black spot disease on the thoracopods.

4.4.2.9. Harvesting and processing techniques

Harvesting of high-density cultures of *Artemia* can be facilitated by taking advantage of the surface respiration behaviour of the animals. When the aeration in the culture tank together with the flow-through and the automatic feeding are interrupted, oxygen levels in the water drop very fast and all waste particles sink to the bottom; after about 30 minutes the *Artemia* respond to the oxygen depletion by concentrating at the water surface where they perform surface respiration. The concentrated population, free from suspended solids, can easily be scooped out with a net of an appropriate mesh size.

When the culture water is not loaded with particles, brine shrimp can be harvested by draining the complete culture over a sieve which should be partially submerged. The *Artemia* should be thoroughly washed preferentially in freshwater or otherwise in seawater. The harvested *Artemia* can then be offered as a most suitable live food for freshwater as well as marine predators. The salinity of the predator culture water is of no concern, as *Artemia* is a hypo-osmoregulator, (i.e. its body fluids have a constant and low salt content of about 9 g.l^{-1}). In seawater, they remain alive without feeding for several days. When transferred into freshwater *Artemia* will continue to swim for another 5 h after which time they eventually die as a result of osmoregulatory stress. Transportation of live brine shrimp can be carried out in plastic bags containing cooled seawater and oxygen.

Harvested *Artemia* which are not directly consumed can be frozen or dried in flakes. In order to ensure optimal product quality, brine shrimp biomass must be frozen immediately after thorough washing with fresh water when still alive. The biomass should be spread out in thin layers (1 cm) in plastic bags or in ice trays and be transferred to a quick freezer (at least -25°C). The adults' exoskeleton is not damaged when the biomass is properly frozen. Upon thawing, the *Artemia* cubes yield intact animals which do not pollute the water by the leaching of body fluids (See also 4.5.7.1).

4.4.2.10. Production figures and production costs

Figure 4.4.14. provides a summary of average production data expressed as *Artemia* survival and length, obtained in the different culture systems described in this chapter. After two weeks of culturing, preadult or adult *Artemia* with an average length of 5 mm or more can be harvested. Under flow-through culture there is a slight but continuous mortality during the whole of the culture period; no significant differences in survival are noticed between open or closed (with recirculation of the culture medium) flow-through cultures. In stagnant culture installations, on the other hand, there is a significantly higher mortality during the end of the

first culture week that can be explained by the deterioration of the water quality, probably because the early naupliar stages are more sensitive than the juvenile or preadult stages.

Average production yields in terms of wet weight biomass harvested after two weeks culture amount to 5 kg, 15 kg and 25 kg live weight *Artemia* per cubic metre of tank volume, respectively for batch production, flow-through systems using micronized feeds, and live algae. These differences in production figures are mainly the result of differences in maximum stocking density at the start and final survival at the end of the culture trial (Table 4.4.9).

It is not evident to estimate production costs for *Artemia* culturing. While fixed costs can be fairly well generalized, operational costs are entirely dependent on local conditions. For instance, local conditions already determine what kind of operation is advisable: open flow-through in regions with abundant clean and warm sea water; but important additional costs are involved when a recirculating unit is necessary. Food should be selected among locally available products. Not only its price but also its processing price is crucial in food selection. Furthermore, it should be micronized mechanically or squeezed through a filter bag manually will again depend on micronization cost compared to local labour cost. Finally, heating and pumping costs are set by diverse local parameters such as electricity costs, ambient temperature, location of seawater stock vis-a-vis culture tanks, etc..

Table 4.4.9. Production characteristics of Great Salt Lake *Artemia* cultures at different animal densities at start of culture.

Density 1(ind./ml)	Survival (%)			Growth (mm)			Biomass (gWW .l ⁻¹)	FCE (g DW food.g WW ⁻¹ biomass)
	day 7	day 10	day 14	day 7	day 10	day 14		
5	82	77	58	3.3	4.7	6.1	15.5	0.66
8	66	50	56	3.2	4.8	5.2	14.5	0.75
10	95	73	72	1.8	2.9	3.5	11.6	0.67
13	61	32	28	-	-	-	8.0	1.13
15	55	41	34	2.0	2.9	3.8	10.0	1.17
18	58	37	29	-	-	-	5.8	1.34
40	74	12	-	1.5	2.3	-	-	-

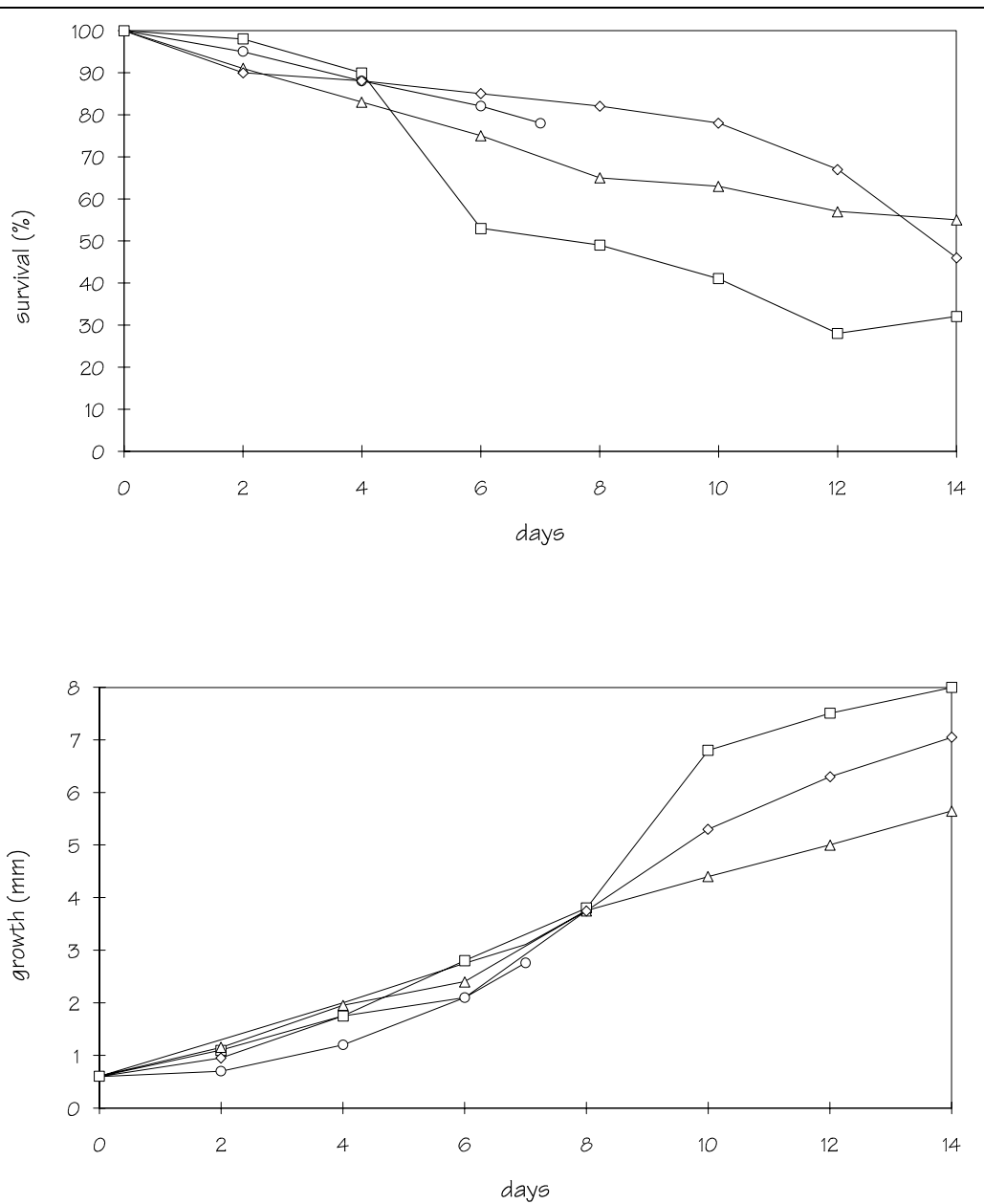

Figure 4.4.14. Survival and growth of Great Salt Lake *Artemia* cultured in different super - intensive systems :

- (◇) 1000 l open flow-through culture on rice bran diet
- (□) 200 l open flow - through culture on *Chaetoceros* diet
- (△) 300 l closed flow - through culture on mixture of soybean waste and corn bran
- (○) 500 l batch culture on a mixture of pea and corn bran

4.4.3. Literature of interest

- Abreu-Grobois, F.A., Briseno-Dueñas, R., Herrera, M.A and Malagon, M.L. 1991. A model for growth of *Artemia franciscana* based on food ration-dependent gross growth efficiencies. *Hydrobiologia* 212: 27-37.
- Bossuyt E., and Sorgeloos, P. 1980. Technological aspects of the batch culturing of *Artemia* in high densities. In: *The Brine Shrimp Artemia*. Vol. 3. Ecology, Culturing, Use in Aquaculture. G. Persoone, P. Sorgeloos, O. Roels and E. Jaspers (Eds). Universa Press, Wetteren, Belgium, pp 133-152.
- Brisset P.J., Versichele, D., Bossuyt, E., De Ruyck, L. and Sorgeloos, P. 1982. High density flow-through culturing of brine shrimp *Artemia* on inert feeds - Preliminary results with a modified culture system. *Aquacultural Engineering* 1(2): 115-119.
- Coutteau P., Brendonck, L., Lavens, P. and Sorgeloos, P. 1992. The use of manipulated baker's yeast as an algal substitute for the laboratory culture of Anostraca. *Hydrobiologia* 234: 25-32.
- Coutteau P., and Sorgeloos, P. 1989. Feeding of the brine shrimp *Artemia* on yeast: effect of mechanical disturbance, animal density, water quality and light intensity. In: *European Aquaculture Society Spec. Publ. N° 10*. Bredene, Belgium, 344 pp.
- D'Agostino, A.S. 1980. The vital requirements of *Artemia*: physiology and nutrition. In: *The Brine Shrimp Artemia*, Vol. 2, Physiology, Biodiversity, Molecular & Biology. G. Persoone, P. Sorgeloos, O. Roels and E. Jaspers (Eds). Universa Press, Wetteren, Belgium, pp 55-82.
- Dhert P., Bombeo, R.B., Lavens, P. and Sorgeloos, P. 1992. A simple semi flow-through culture technique for the controlled super-intensive production of *Artemia* juveniles and adults. *Aquacultural Engineering* 11: 107-119.
- Dhont J., Lavens, P. and Sorgeloos, P. 1993. Preparation and use of *Artemia* as food for shrimp and prawn larvae. In: *CRC Handbook of Mariculture*. 2nd Edition. Vol 1: Crustacean Culture. J.V. Mc Vey (Ed). CRC Press, Inc., Boca Raton, Florida, USA, pp 61-93.
- Dobbeleir J., N. Adam, E. Bossuyt, E. Bruggeman, and P. Sorgeloos 1980. New aspects of the use of inert diets for high density culturing of brine shrimp. In: *The brine Shrimp Artemia*. Vol. 3. Ecology, Culturing, Use in Aquaculture. G. Persoone, P. Sorgeloos, O. Roels, and E. Jaspers (Eds). Universa Press, Wetteren, Belgium, pp 165-174.

- Lavens P., Baert, P., De Meulemeester, A., Van Ballaer, E. and Sorgeloos, P. 1986. New developments in the high density flow-through culturing of brine shrimp *Artemia*. *Journal of the World Mariculture Society* 16: 498-508.
- Lavens P., and Sorgeloos, P. 1987. Design, operation, and potential of a culture system for the continuous production of *Artemia* nauplii. In: *Artemia* Research and its Applications. Vol. 3. Ecology, Culturing, Use in Aquaculture P. Sorgeloos, D. Bengtson, W. Declair and E. Jaspers (Eds) Universa Press, Wetteren, Belgium : 339-345.
- Lavens P., Léger, P. and Sorgeloos, P. 1989. Manipulation of the fatty acid profile in *Artemia* offspring produced in intensive culture systems. In : *Aquaculture - A biotechnology in progress*. N. De Pauw, E. Jaspers, H. Ackefors, N. Wilkins (Eds). European Aquaculture Society, Bredene, Belgium, pp 731-739.
- Lavens P., and Sorgeloos, P. 1991. Chapter XIII : Production of *Artemia* in culture tanks. In: *Artemia* Biology. R.A. Browne, P. Sorgeloos and C.N.A. Trotman (Eds). CRC Press, Inc. Boca Raton, Florida, USA, pp 317-350.
- Léger P., Bengtson, D.A., Simpson, K.L. and Sorgeloos, P. 1986. The use and nutritional value of *Artemia* as a food source. *Oceanogr. Mar. Biol. Ann. Rev.* 24: 521-623.
- Tobias W.L., Sorgeloos, P., Roels, O.A. and Sharfstein, B.A. 1980. International study on *Artemia*. XIII. A comparison of production data of 17 geographical strains of *Artemia* in the St. Croix artificial upwelling mariculture system. In: *The brine Shrimp Artemia*. Vol. 3. Ecology, Culturing, Use in Aquaculture. G. Persoone, P. Sorgeloos, O. Roels and E. Jaspers (Eds). Universa Press, Wetteren, Belgium, pp 384-392.
- Vanhaecke P., and Sorgeloos, P. 1989. International study on *Artemia*. XLVII. The effect of temperature on cyst hatching, larval survival and biomass production for different geographical strains of brine shrimp *Artemia* spp. *Annls Soc. r. zool. Belg* 119: 7-23.

4.4.4. Worksheets

WORKSHEET 4.4.1 : FEEDING STRATEGY FOR INTENSIVE *ARTEMIA* CULTURE.

During first week :

- T < 15 cm ; stop feeding and/or increase water renewal;
- 15 cm < T < 20 cm; maintain actual feeding ratio;
- T > 20 cm; increase feeding ratio and/or add food manually.

During next week :

- T < 20 cm : stop feeding and/or increase water renewal;
- 20 cm < T < 25 cm; maintain actual feeding ratio;
- T > 25 cm; increase feeding ratio and/or add food manually.

From pre-adult stage: daily food ratio = 10% of WW biomass.l⁻¹ culture water. The WW biomass.l⁻¹ is measured as follows :

- collect some liters of culture over a sieve that, withholds the animals;
- rinse with tapwater;
- let water dug & dip the sieve with paper cloth;
- weigh the filter; WW biomass.l⁻¹ = (total weight - weight empty filter) (volume of sampled culture water)⁻¹.

4.5. Pond production

Peter Baert, Thomas Bosteels and Patrick Sorgeloos

Laboratory of Aquaculture & Artemia Reference Center
University of Gent, Belgium

4.5.1. Description of the different *Artemia* habitats

As was explained earlier *Artemia* populations are widely distributed over the five continents in a variety of biotopes. Culture methods largely depend on pond size and available infrastructure. In this text we make a distinction between the following *Artemia* production systems.

4.5.1.1. Natural lakes

High saline lakes in which natural *Artemia* populations are present. Such lakes can be small (Egypt: Solar Lake) of medium size (California, USA: Mono Lake; Cyprus: Larnaca Lake) or large (Utah, USA: Great Salt Lake; Iran: Lake Urmia; Canada: Chaplin Lake).

In these inland lakes population densities are usually low and mainly fluctuate in function of food availability, temperature and salinity. The size and/or often complete absence of suitable infrastructure makes management of such lakes very difficult, restricting the main activity to extensive harvesting of *Artemia* biomass and/or cysts.

4.5.1.2. Permanent solar salt operations

Mechanized operations consisting of several interconnected evaporation ponds and crystallizers. In these salt operations, ponds can have sizes of a few to several hundred hectares each with depths of 0.5 m up to 1.5 m. For a schematic outline of a typical permanent salt work see Fig. 4.5.1. (Port Said; Egypt: El Nasr Salina company).

Sea water is pumped into the first pond and flows by gravity through the consecutive evaporation ponds. While passing through the pond system salinity levels gradually build up as a result of evaporation. As the salinity increases, salts with low solubility precipitate as carbonates and sulfates (Fig. 4.5.2.). Once the sea water has evaporated to about one tenth of its original volume (about 260 g.l⁻¹), mother brine is pumped into the crystallizers where sodium chloride precipitates.

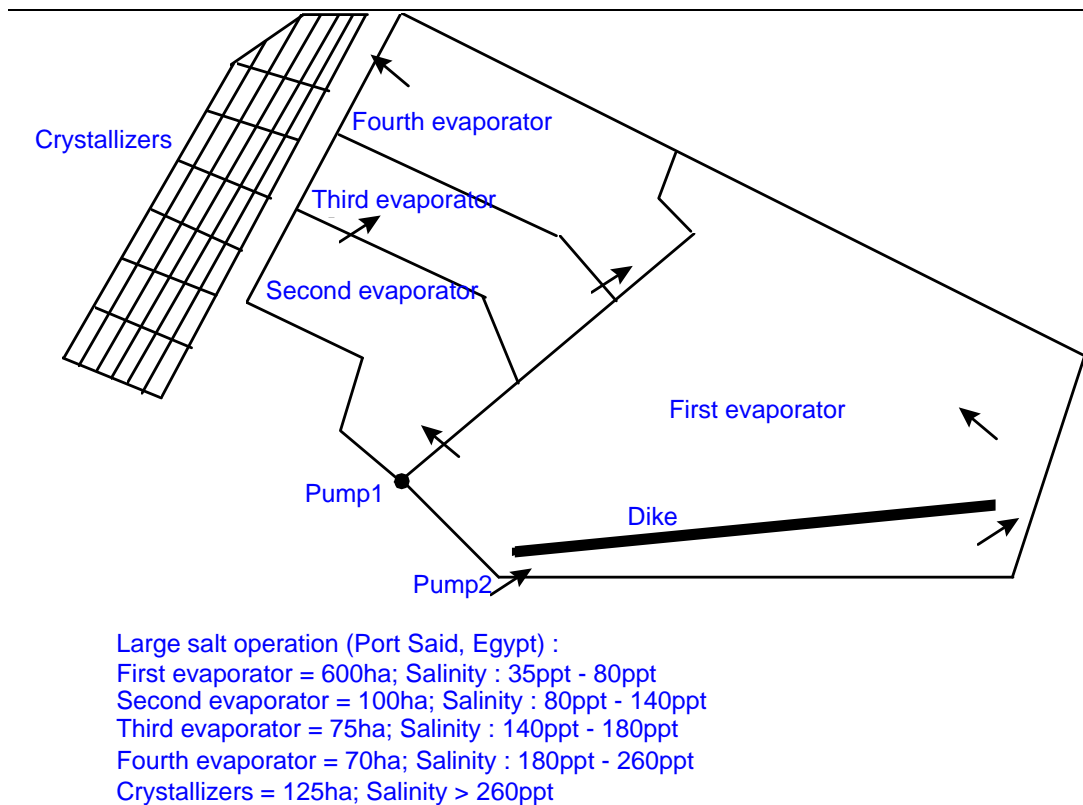

Figure 4.5.1. Schematic outline of a typical salt work.

Before all sodium chloride has crystallized, the mother liquor, now called bittern, has to be drained off. Otherwise the sodium chloride deposits will be contaminated with $MgCl_2$, $MgSO_4$ and KCl which start precipitating at this elevated salinity (Fig. 4.5.2.). The technique of salt production thus involves fractional crystallization of the salts in different ponds. To assure that the different salts precipitate in the correct pond, salinity in each pond is strictly controlled and during most of the year kept at a constant level.

Brine shrimp are mainly found in ponds at intermediate salinity levels. As *Artemia* have no defense mechanisms against predators, the lowest salinity at which animals are found is also the upper salinity tolerance level of possible predators (minimum 80 g.l^{-1} , maximum 140 g.l^{-1}). From 250 g.l^{-1} onwards, animal density decreases. Although live animals can be found at higher salinity, the need of increased osmoregulatory activity, requiring higher energy inputs, negatively influences growth and reproduction, eventually leading to starvation and death. Cysts are produced in ponds having intermediate and high salinity (80 g.l^{-1} to 250 g.l^{-1}).

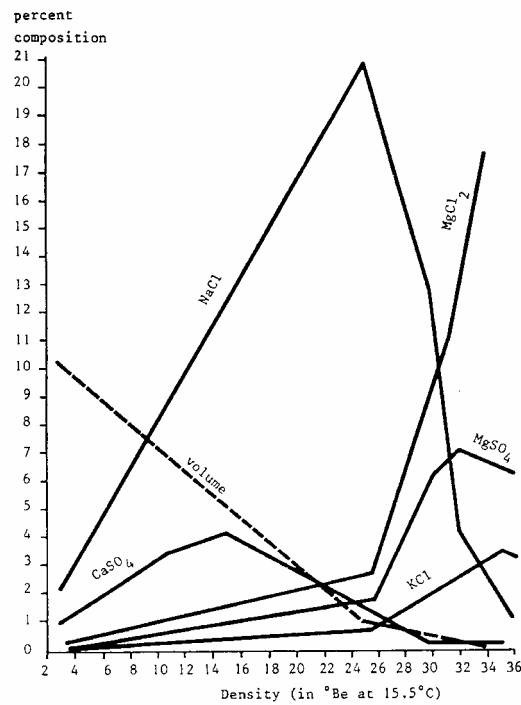

Figure 4.5.2. Precipitation of salts with increased salinity

The population density depends on food availability, temperature and salinity. The availability of pumping facilities and intake canals allows manipulation of nutrient intake and salinity. Sometimes fertilization can further increase yields. Still, numbers of animals and thus yields per hectare are low.

Moreover the stable conditions prevailing in the ponds of these salt works (constant salinity, limited fluctuations in oxygen as algal concentrations are fairly low, etc.) often results in stable populations in which the ovoviviparous reproduction mode dominates. The selective advantage of ovoviviparous females in these salt works, could also explain the decrease of cyst production which is very typical for stable biotopes (e.g. salt works in NE Brazil).

In salt works *Artemia* should not only be considered as a valuable byproduct. The presence of brine shrimp also influences salt quality as well as quantity.

In salt works algal blooms are common, not the least because of the increase of nutrient concentration with evaporation. The presence of algae in low salinity ponds is beneficial, as they color the water and thus assure increased solar heat absorption, eventually resulting in faster evaporation. At elevated salinity, if present in large numbers, algae and more specifically their dissolved organic excretion and decomposition products will prevent early precipitation of gypsum, because of increased viscosity of the water. In this case gypsum, which precipitates too late in the crystallizers together with the sodium chloride, will contaminate the salt, thus reducing its quality.

Furthermore, accumulations of dying algae which turn black when oxidized, may also contaminate the salt and be the reason for the production of small salt crystals. In extreme situations the water viscosity might even become so high that salt precipitation is completely inhibited.

The presence of *Artemia* is not only essential for the control of the algal blooms. The *Artemia* metabolites and/or decaying animals are also a suitable substrate for the development of the halophilic bacterium *Halobacterium* in the crystallization ponds. High concentrations of halophilic bacteria - causing the water to turn wine red - enhance heat absorption, thereby accelerating evaporation, but at the same time reduce concentrations of dissolved organic matter. This in turn leads to lower viscosity levels, promoting the formation of larger salt crystals, thus improving salt quality.

Therefore, introducing and managing brine shrimp populations in salt works, where natural populations are not present, will improve profitability, even in situations where *Artemia* biomass and cyst yields are comparatively low. In most of the salt works natural *Artemia* populations are present. However, in some *Artemia* had to be introduced to improve the salt production.

4.5.1.3. Seasonal units

We are referring here to small artisanal salt works in the tropical-subtropical belt that are only operational during the dry season.

In artisanal salt works ponds are only a few hundred square meters in size and have depths of 0.1 to 0.6 m. In Fig. 4.5.3. the lay-out of a typical artisanal salt farm is given (Vinh Tien salt co-operative - Viet Nam). Most salt farms only operate during a few months, when the balance evaporation/precipitation is positive. Salt production is abandoned during the rainy season, when evaporation ponds are often turned into fish/shrimp ponds.

Although salt production in these salt streets is based on the same chemical and biological principles as in the large salt farms, production methods differ slightly (Vu Do Quynh and Nguyen Ngoc Lam, 1987).

At the beginning of the production season all ponds are filled with sea water. Water is supplied by tidal inflow, but small portable pumps, wind mills and/or manually operated water-scoopers are also used, allowing for better manipulation of water and salinity levels.

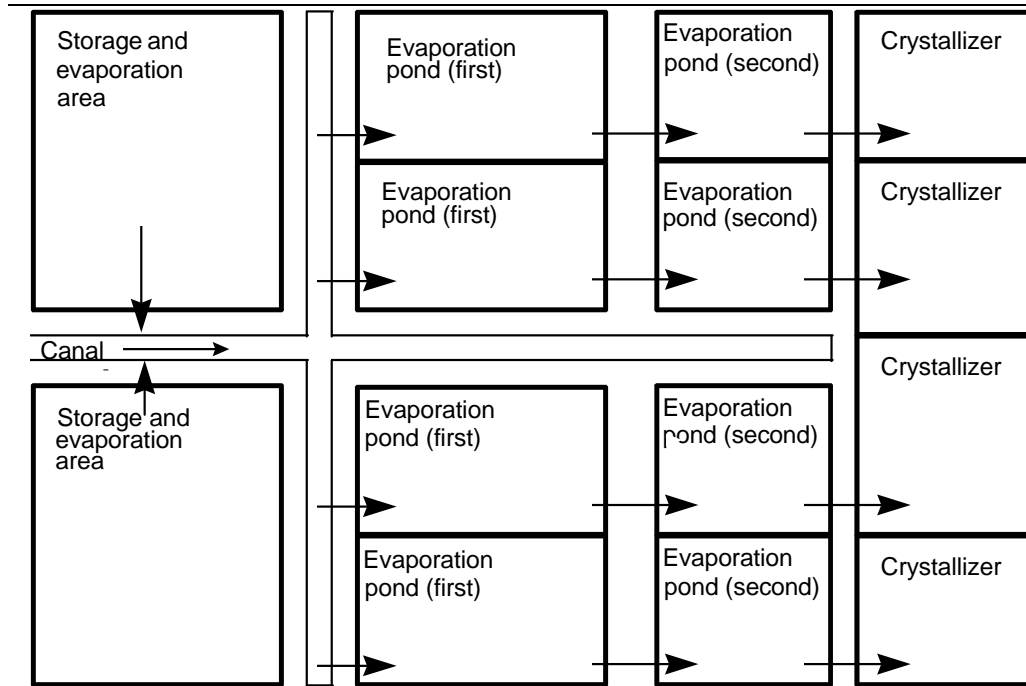

Small salt operation (Vinh Tien, Vietnam)

Storage and evaporation area = 0.4ha - 1ha; salinity : 10ppt - 50ppt

Evaporation pond (first series) = 0.2ha - 0.5ha; Salinity : 40ppt - 120ppt

Evaporation pond (second series) = 0.2ha - 0.5ha; Salinity : 80ppt - 160ppt

Crystallizers = 0.2ha - 0.5ha; 120ppt - all water evaporated.

Figure 4.5.3. Lay-out of a typical artisanal salt farm.

Water evaporates and, usually just before the next spring tide, all the water, now having a higher salinity than sea water, is concentrated in one pond. All other ponds are re-filled with sea water, which once again is evaporated and concentrated in a second pond. This process is repeated until a series of ponds is obtained in which salinity increases progressively, but not necessarily gradually!

For the remainder of the season water is kept in each pond until the salinity reaches a predetermined level and is then allowed to flow into the next pond holding water of a higher salinity. Note that the salinity in the different ponds is not kept constant as in permanently operated salt works. Sometimes, to further increase evaporation, ponds are not refilled immediately but left dry for one or two days. During that time the bottom heats up, which further enhances evaporation. Once the salinity reaches 260 g.l^{-1} , water is pumped to the crystallizers, where the sodium chloride precipitates. *Artemia* thrive in ponds where salinity is high enough to exclude predators (between 70 g.l^{-1} and 140 g.l^{-1}).

As seasonal systems often are small they are fairly easy to manipulate. Hence higher food levels and thus higher animal densities can be maintained. Also, factors such as temperature (shallow ponds), oxygen level (high algal density, use of organic manure) and salinity (discontinuous pumping) fluctuate creating an unstable environment. This, together with the fact that population cycles are yearly interrupted seems to favor oviparous reproduction.

Integrated systems in which *Artemia* culture (high salinity) is combined with the culture of shrimp or fish (stocked in the ponds with lower salinity) also exist. As for the small salt works, brine shrimp culture usually depends on the availability of high saline water and is often limited to certain periods of the year. Management of these ponds is similar to the management of the *Artemia* ponds in artisanal salt farms.

Intensive *Artemia* culture in ponds can also be set up separately from salt production. Ponds are filled with effluent of fish/shrimp hatcheries and/or grow-out ponds. As salinity in these systems are often too low to exclude predators (45 to 60 g.l⁻¹), intake water is screened, using filter bags or cross-flow sieves. Agricultural waste products (e.g. rice bran) and chicken manure can be used as supplemental feeds. Systems can be continuous (at regular intervals small amounts of nauplii are added to the culture ponds) or discontinuous (cultures are stopped every two weeks).

4.5.2. Site selection

Obviously integrating *Artemia* production in an operational solar salt work or shrimp/fish farm will be more cost-effective. Ponds can be constructed close to evaporation ponds with the required salinity, or low salinity ponds already existing in the salt operation can be modified.

In what follows we will not give a detailed account of all aspects related to pond construction and site selection. We will only summarize those aspects which should be specifically applied for *Artemia* pond culture. For more detailed information we refer the reader to specialized handbooks for pond construction.

4.5.2.1. Climatology

The presence of sufficient amounts of high saline water is of course imperative, although filtration techniques to prevent predators from entering culture ponds can be applied for short term cultures (filtration less than 70 µm). Therefore, *Artemia* culture is mostly found in areas where evaporation rates are higher than precipitation rates during extended periods of the year (e.g. dry season of more than four months in the tropical-subtropical belt).

Evaporation rates depend on temperature, wind velocity and relative humidity. Especially when integrating *Artemia* ponds in fish/shrimp farms, evaporation rates should be studied. On the other hand, the presence of solar salt farms in the neighbourhood is a clear indication that *Artemia* pond culture is possible during at least part of the year.

As temperature also influences population dynamics directly, this climatological factor should receive special attention. Too low temperatures will result in slow growth and reproduction whereas high temperatures can be lethal. Note that optimal culture temperatures are strain dependent (see further).

4.5.2.2. Topography

The land on which ponds will be constructed should be as flat as possible to allow easy construction of ponds with regular shapes. A gradual slope can eventually facilitate gravity flow in the pond complex.

The choice between dugout (entirely excavated) and level ponds (bottom at practically the same depth as the surrounding land and water retained by dikes or levees) will depend on the type of ponds already in use. Locating the *Artemia* ponds lower than all other ponds is good practice, as the water flow into the ponds is much higher than the outflow (usually ponds are only drained at the end of the culture season). Making use of gravity or tidal currents to fill the ponds, even if only partially, will reduce pumping costs.

4.5.2.3. Soil conditions

Because long evaporation times are needed to produce high salinity water, leakage and/or infiltration rates should be minimal.

Heavy clay soils with minimal contents of sand are the ideal substrate. As leakage is one of the most common problems in fish/shrimp farms and even in large salt works construction of a small pilot unit at the selected site, prior to embarking on the construction of large pond complexes, might avoid costly mistakes.

An additional problem might be the presence of acid sulfate soils, often found in mangrove or swamp areas. Sometimes yellowish or rust-colored particles can be observed in the surface layers of acid sulfate soils. When exposed to air such soils form sulfuric acid, resulting in a pH drop in the water. At low pH it is very difficult to stimulate an algae bloom. As algae constitute an important food source for the *Artemia*, yields are low in such ponds. Treatment of acid-sulfate soils is possible (see further), but costly.

The presence of lots of organic material in the pond bottom might also cause problems. Especially when used for dike construction, such earth tends to shrink, thus lowering the dike height considerably. Moreover, problems with oxygen depletion at the pond bottom, where organic material is decomposing, can arise. Using such soils over several years will lower the organic content. Nevertheless, many problems will have to be solved during the first years.

4.5.3. Pond adaptation

4.5.3.1. Large permanent salt operations

In large salt operations, adaptation of the existing ponds is normally not possible. However, ponds are mostly large, deep and have well constructed dikes. Through aging and the development of algal mats their bottoms are properly sealed. Therefore the only adaptation needed is the installation of screens to reduce the number of predators entering the evaporators. This is especially important in regions where predators are found at high salinity (e.g. the Cyprinodont fish *Aphanius*).

Two types of filters can be used: filter bags (in plastic mosquito-screen, polyurethane or nylon), or stainless steel screens. The characteristics of each type of screening material are summarized in Table 4.5.1.

Table 4.5.1. Characteristics of filter units used in large salt operations

Type	Characteristics
Filterbags	Material available on most local markets, reasonably cheap. Large filtration area (depends on size bag). Filtration of particles with diameter of 2 to 5 mm possible depending on available material. Difficult to maintain (daily cleaning, high risk of damaging screens). Have to be replaced regularly. Only available in a few mesh sizes. Not suited for heavier debris (wood, plastic), which will damage the nets.
Stainless Steel	Sometimes has to be imported. Rather expensive. Filtration area usually smaller than for filterbags, but screens with a mesh-size of 1 mm can be used if cleaned regularly. Easier to clean, screens with small mesh size should be cleaned daily. Stronger, can last several years and can retain heavier debris. Available in several mesh sizes.

As intake water is often heavily loaded with particles, step-by-step screening is recommended. Different screens, each with a smaller mesh size than the previous one, are placed one after the other. Screens with a large mesh size are best installed before the pumps, while screens with smaller mesh sizes are installed behind the pumps. If predators, resisting high salinity, are present, screening of the gates between the evaporation ponds is also recommended.

Both stainless steel screens and filter bags should be cleaned regularly. Stainless steel screens are cleaned with a soft brush. Filter bags can be cleaned by reversing the bags. When cleaning or replacing filters, there is a risk of predators entering the culture ponds. Therefore before cleaning, predators (fish, shrimp) in the vicinity of the screens should be killed by spraying a mixture of urea and bleaching powder on the water surface (0.010 kg to 0.015 kg urea.m⁻³ and 0.007 to 0.01 kg bleaching powder 70%.m⁻³).

4.5.3.2. Small pond systems

In the artisanal saltworks ponds are very often operated at very small depths, sometimes resulting in too high water temperatures for *Artemia* (> 40°C) and promoting phyto-benthos rather than the required phytoplankton. For integration of *Artemia* production, ponds should be deepened, dikes heightened and screens should be installed to prevent predators from entering the culture ponds.

Under windy conditions (which often prevail in the afternoon hours in tropical/subtropical salt works) high wave action will enhance the evaporation. However to reduce foam formation (in which cysts get trapped) at the down wind side of the pond, wave breakers should be installed (Fig. 4.5.4.). These wave breakers will also act as cyst barriers and facilitate their harvesting.



Figure 4.5.4. Floating bamboo poles used as wave breakers for the harvesting of *Artemia* cysts.

DEEPENING THE PONDS

Especially in regions with high air temperatures, deepening the ponds is crucial. Depths of 40 cm to 50 cm are to be recommended. High water levels are not only needed to prevent lethal water temperatures but at the same time reduce growth of benthic algae (i.e. sunlight cannot reach the pond bottom). Development of phytobenthos is undesirable as it is too large for *Artemia* to ingest and prevents normal development of micro algae (i.e. macro algae remove nutrients more efficiently from pond water than micro algae). Moreover, floating phytobenthos reduces evaporation rates and hampers cyst collection.

Ponds are usually deepened by digging a peripheral ditch and using the excavated earth to heighten the dikes. Although this is good practice, this method has two major draw-backs as evaporation rates depend upon the ratio "pond surface: pond volume". In deeper ponds a decreased ratio leads to a slower increase in salinity. At the start of the culture season, this can limit the pumping of nutrient-rich water into the culture ponds, thus reducing *Artemia* growth and reproductive output. Also, more water is needed to fill such ponds. This might delay the start of the culture period in regions where no permanent stocks of high saline water are available (i.e. in Vietnam more than one extra month is needed, to completely fill ponds with a deep peripheral ditch). Alternatively the area in which *Artemia* is cultured can be reduced while the area allocated for evaporation is increased.

Therefore, if the complete pond is deepened, low initial water levels (15 cm to 20 cm) are to be preferred unless water temperature is higher than 34°C or phytobenthos starts developing (low turbidity). A faster increase in salinity will allow more pumping and favor *Artemia* growth (cf. higher nutrient intake). Also, earlier inoculation of ponds will be possible.

However, in ponds with peripheral ditches, only filling ditches at the onset of the culture season is bad practice. Not only will the ratio surface: volume be much smaller when compared to ponds with submerged central platforms but also risks of oxygen depletion in the ditch will be high (i.e. oxygen influx in the pond also depends upon ratio surface: volume).

At the onset of the season a ratio "pond surface: pond volume" larger than 3:1 seems acceptable (pond surface expressed in m^2 , pond volume expressed in m^3 ; water level above platform 0.2 m). Nonetheless, as this ratio largely depends upon the local evaporation rates, further experimentation at the site is advisable.

DIKE CONSTRUCTION

To prevent leakage, newly constructed dikes need to be well compacted. When heightening old dikes, leaks will mostly occur at the interface of old and new soil. To prevent such leaks from occurring, the old dike should first be wetted and ripped before new soil is added. Dikes are often inhabited by crabs, digging holes through the dike. Filling nests with CaO and clay will reduce leaks caused by burrowing crabs. To prevent excessive erosion of the dikes, slopes should have a 1:1 ratio (height: width).

SCREENING

Intake waters should also be screened to prevent predators from entering the culture ponds. The same type of filters as described for large salt operations can be used. Moreover, the small size of the ponds allows the use of so-called filter boxes. In such a box a stainless-steel welded-wedge filter is installed under an adjustable angle (Fig. 4.5.5.). Water is lifted by a pump into an overhead compartment from where the water is drained over the filter screen. Mesh sizes of $120\ \mu m$ have been tested with good result. The angle under which the screen is mounted influences the velocity of the water flow, which will determine the virtual mesh-opening of the filter.



Figure 4.5.5. Close-up of welded-wedge filter screen and filtered zooplankton.

When using such filters even small competitors such as copepods can be removed (up to 90%). Results are especially good, when *Artemia* culture periods are relatively short (6 to 8 weeks). The major draw-back is the high initial cost of these units (approx. 500 US\$.m⁻² of screen). This restricts their use to regions where high saline water is not abundant and/or where the presence of (small) predators seriously hampers *Artemia* culture.

4.5.4. Pond preparation

4.5.4.1. Liming

The chemicals used for liming are the oxides, hydroxides and silicates of calcium and magnesium. The liming substances most often used in aquaculture are agricultural lime, CaO or quicklime and Ca(OH)₂ or hydrated lime.

Normally ponds used to culture *Artemia* do not need liming. The high saline water often has a hardness of more than 50 mg CaCO₃.l⁻¹ (due to the presence of carbonates). Liming ponds with such hardness will not further improve yields. Liming can be considered when culture water has a pH of less than 7.5 and stimulating an algae bloom is difficult.

Using CaO and Ca(OH)₂ will result in a quick pH rise to about 10. This way possible pathogens and predators will be killed. CaO and Ca(OH)₂ are therefore often used to disinfect the pond bottom. After two to three days, pH drops to 7.5, after which normal mineralization takes place.

Recommended doses vary between 500 to 1000 kg CaCO₃ per hectare, to be applied to dry pond bottoms. The lime requirement is highest for clay bottoms, acid bottoms and when the pond water has a low concentration of Ca²⁺ and Mg²⁺ (note that in high saline waters Ca²⁺ and Mg²⁺ concentrations are usually high). If liming is the standard, exact requirements should be determined by a qualified lab, using the technique as described by Boyd (1990).

Whereas drying can be beneficial for most soils this is not true for acid-sulfate soils, often found in mangrove areas. When exposed to the air, the pyrite of these soils oxidizes to form sulfuric acid. Of course liming of these soils is possible. However, the quantities of lime needed are very high. A simpler method to reduce acidity is flushing ponds repeatedly after oxidation (exposing the soil to the air). This procedure can take a long time. Therefore, such type of bottom usually is kept submerged and extra layers of oxidized acid free soil are added on top of the original substrate. Culturing brine shrimp in regions with acid sulphate soils should be avoided.

4.5.4.2. Predator control

LARGE SALT OPERATIONS

Removal of predators in large salt operations is very difficult. Careful screening of intake water (see 4.5.3.1) and restricting the culture of *Artemia* to high-salinity ponds is of the utmost importance. If large numbers of predators are found in the culture ponds manual

removal (i.e. trawl nets) and killing fish/shrimp accumulating at the gates using a mixture of urea and bleach (0.01 to 0.015 kg urea.m⁻³ and 0.007 to 0.01 kg bleaching powder 70%.m⁻³), decreasing their number to acceptable levels, will be necessary.

SMALL PRODUCTION PONDS

Initially ponds should only be filled to a level of 10 to 15 cm, in order to ensure maximum evaporation. Thus salinity lethal for predators will be obtained.

Screening of the intake water will further reduce the number of predators in the pond (see further).

As ponds often can not be drained completely, fish, crab and shrimp left in puddles, may be killed using rotenone (0.05 to 2.0 mg.l⁻¹), tea-seed cake (15 mg.l⁻¹), a combination of urea and hypochlorite (5 mg.l⁻¹ urea and 24 h later 5 mg.l⁻¹ hypochloride CaO) (see 4.5.4.1) or derris root (1 kg.150 m⁻³). Dipterex (2 mg.l⁻¹) will kill smaller predators such as copepods and is also very toxic for shrimp. The degradation of rotenone, chlorine and CaO to non-toxic forms is fairly rapid (24 - 48 h). If on the other hand tea-seed cake or dipterex are used, ponds should be flushed prior to stocking animals.

4.5.4.3. Fertilization

Fertilizers are added to the culture ponds to increase primary production (algae production). Increasing production is no simple process, especially in high saline water. Numerous factors influence the chemistry of the fertilizers (ion composition of sea water, pH, pond bottom, etc.), algal growth (temperature, salinity, sunlight) and species composition (N:P ratio, selective grazing pressure).

As can be seen in Fig. 4.5.6. fertilizers can enter the culture system via different pathways. The inorganic nutrients C, N, P enter the photo-autotrophic pathway, used by photosynthesising algae, whereas organic nutrients are processed through the heterotrophic pathways, used by heterotrophic bacteria, or are consumed directly by the target species.

Some algae are better suited as food for *Artemia* than others (see further). Manipulation of algal composition is until now still more of an art than a science. Usually a high N:P ratio is recommended (N:P of 10) if the growth of green algae (*Tetraselmis*, *Dunaliella*) and diatoms (*Chaetoceros*, *Navicula*, *Nitzschia*) is desirable. However, as phosphorus dissolves badly in salt water and is absorbed very quickly at the pond bottom, N:P ratios of 3 to 5 might be more appropriate.

Four types of inorganic nitrogen fertilizers are available.

Ammonium fertilizers: $(\text{NH}_4)_2\text{SO}_4$	20.5% N Acidifying effect (acidity $-33.6 \text{ kg CaCO}_3 \cdot 100\text{kg}^{-1}$ fertilizer). NH_4^+ can replace Ca and Mg in the bottom, as a result decrease buffer capacity and/or stimulate precipitation of phosphates and sulphates.
Nitrate fertilizers: $\text{Ca}(\text{NO}_3)_2$	15-16%N Increases pH Fast action (nitrate directly available for the algae).
Amide fertilizers:	46%N
Urea:	Acidifying affect (acidity $-25.2\text{kg CaCO}_3 \cdot 100 \text{ kg}^{-1}$ fertilizer). Lowers temperature. Slow action. Readily soluble.

The need of nitrogen fertilization varies largely and should be determined experimentally for every site. Usually, adding between $1 \text{ mg} \cdot \text{l}^{-1}$ (eutrophic intake water) to $10 \text{ mg} \cdot \text{l}^{-1}$ (oligotrophic water) nitrogen will induce an algae bloom.

We can give the following general recommendations:

- o Pre-dissolving the fertilizers in fresh water, even when using liquid fertilizers enhances proper distribution over the complete pond. If fertilizers dissolve easily, hanging a bag behind a boat and dragging it through the culture pond gives an even better distribution. Platforms in front of the inlet can also be used.
- o Liquid fertilizers, containing nitrate are more effective than other nitrogen fertilizers.
- o Do not fertilize on a cloudy day (reduced sunlight) as algae growth will be limited by the low light levels.
- o It is best to fertilize only the low salinity ponds in a flow-through system. Initiating an algae bloom in high salinity ponds is difficult and can take more than one month. The algae and organic matter created in the low salinity ponds are drained to the high salinity ponds and are there available as food.
- o Conditions in the fertilizer ponds should be kept as constant as possible to enhance optimal growth conditions for the desired algae.
- o The use of inorganic fertilizers in *Artemia* culture ponds is not recommended (except before introducing the nauplii) as algal densities are not limited by the nutrient concentrations but rather by the grazing pressure exercised by the brine shrimp.

In large salt operations costs might limit the use of fertilizers. Regular pumping is often more effective in controlling the *Artemia* standing crop. When pumping, new nutrients and CO₂ enter the culture ponds. This will stimulate algal growth, especially in areas where intake water is nutrient rich (turbidities less than 40 cm), no additional fertilization should be used. If the intake water contains only low nitrogen levels, fertilizing low salinity ponds could enhance *Artemia* production.

As pumping influences the retention time of the nutrients in the ponds (i.e. at high pumping rates algae will not have time to take up nutrients) fertilization should be combined with lower pumping rates, in systems with short retention times.

To determine correct fertilization needs in the smaller systems we recommend to proceed as follows:

- o Calculate the amount of fertilizer needed to increase the nitrogen level with 1 mg.l⁻¹ (1 ppm).

Example: pond volume = 1000 m³.

As ppm = g.m⁻³ in total 1,000 g has to be added to the pond.

If urea is used, (1000: 0.46) = 2,174 g urea must be added to the pond (urea contains only 46% N).

- o If algae do not develop after 2 days, add a new dose of 1 mg.l⁻¹ until a turbidity of 30 to 40 cm is obtained.
- o Once an algae population is established, fertilize at least once a week. If during the week turbidity drops under 50 cm, decrease time between fertilizations or add more fertilizer. If turbidity becomes higher than 15cm, increase time between fertilizations or add less fertilizer.
- o Regular pumping adding new CO₂ to the water and diluting cultures is essential.

Ideally, algae turbidity should be kept between 20 and 40 cm in the *Artemia* culture ponds, through regular water intake from the fertilization ponds. Turbidities of less than 20 cm might result in oxygen stress at night, especially when temperatures are high.

Also other factors influencing primary production should be taken into account (i.e. temperatures, low sunlight on cloudy days). If climatic conditions are limiting algae growth, extra fertilization will not increase primary production.

- Phosphorus fertilization

As with nitrogen, phosphorus enters the culture ponds with the intake water in the form of organic material which only becomes available through bacterial decomposition. Phosphorus is also found in the soil where it is bound under the form of AlPO₄.2H₂O or FePO₄.2H₂O (sometimes 300 times more than in the water). This phosphorus can be released into the water. The processes describing this release are up to now poorly understood. It is however clear that bacteria together with the Fe-ion play an important role. In an aerobic conditions and when the pH is low, phosphates are released into the

water. Most phosphorus fertilizers precipitate, especially in salt water ponds (i.e. reaction with Ca^{2+}).

Phosphorus is also quickly absorbed at the pond bottom. In cases where the use of phosphorus fertilizers is desirable, fertilizers with a small grain size which dissolve easily in water, should be selected. Pre-dissolving the fertilizer in freshwater will improve its availability. In Table 4.5.3. we list the characteristics of some phosphorus fertilizers.

The rule for phosphorus fertilization is small quantities as often as possible. Adding phosphorus twice a week is normal practice. Again, no exact rules specifying the amounts of phosphorus fertilizer can be given. We therefore recommend to follow the same procedure as described for nitrogen fertilizer. But as a rule of thumb three to five times less phosphorus than nitrogen should be added to culture ponds.

Table 4.5.3. Phosphorous fertilizers

Superphosphate: $\text{Ca}(\text{H}_2\text{PO}_4)_2 \cdot \text{H}_2\text{O}$	16-20% P_2O_5 . High solubility
Dicalcium phosphate: $\text{CaHPO}_4 \cdot 2\text{H}_2\text{O}$	35-48% P_2O_5 Low solubility
Triple superphosphate $\text{Ca}(\text{H}_2\text{PO}_4)_2 \cdot \text{H}_2\text{O}$	42-48% P_2O_5 Good solubility
Sodiumpolyphosphate	46% P_2O_5 Liquid
Phosphoric acid	54% P_2O_5 Liquid

ORGANIC FERTILIZERS

With the appearance of inorganic fertilizers the use of organic fertilizers has been questioned. In Table 4.5.4. we summarize advantages and disadvantages of organic fertilizers.

The organic fertilizers most often used in aquaculture are chicken, quail and duck manure. Cow, pig and goat dung have also been used but seem to stimulate phytobenthos.

Cottonseed meal, rice bran and other agricultural waste products have also been used. The use of rice bran is only recommended if there is a serious food shortage (i.e. very slow growth of the animals). As these products are expensive and contain a lot of undigestible fiber, which eventually accumulates on the pond bottom, they should only be used for a limited period of time.

Recommended levels of organic manure are 0.5 to $1.25 \text{ ton} \cdot \text{ha}^{-1}$ at the start of the production season with dressings of 100 to $200 \text{ kg} \cdot \text{ha}^{-1}$ every 2 to 3 days. In Vietnam, about $500 \text{ kg} \cdot \text{ha}^{-1} \cdot \text{week}^{-1}$ of chicken manure is used as soon as algae concentrations decrease. When adding organic fertilizers to culture ponds, water should be turbid, otherwise benthic algae most certainly will develop.

Table 4.5.4. Advantages and disadvantages of organic fertilizers.**Advantages**

Organic fertilizers contain apart from nitrogen and phosphorus other minerals which can have a beneficial effect on the plankton growth.

Organic fertilizers have a very beneficial effect on the pond bottom. The adsorption capacity will be greatly increased (higher potential buffer capacity) and the microflora will be enhanced. However, an increase in bacteria is only beneficial if the C:N ratio is lower than 30. If this is not the case bacteria might use nitrogen components from the water column to sustain their growth. In this case adding inorganic nitrogen fertilizers is recommended.

Organic fertilizers contain protein, fat and fibre. Fertilizer particles coated with bacteria can be used directly as food by the cultured species. *Artemia*, a non selective filter feeder obtains part of its food in this way.

Organic fertilizers often float (chicken manure). Therefore the loss of phosphorus is reduced.

By using organic fertilizers one usually recycles a waste product, which otherwise would have been lost.

Disadvantages

The composition of organic fertilizers is variable. This makes standardization of the fertilization procedures difficult. As they also contain considerable amounts of phosphorus, problems with benthic and blue green algae can arise.

Organic fertilizers have to be decomposed. Their action is therefore slower, increasing the risk of losses.

As organic fertilizers stimulate bacterial growth, their use greatly increases the oxygen demand. Using too much fertilizer can result in oxygen depletion and mortality of the cultured species. Increased bacterial activity also increases the acidity of the bottom.

The use of organic fertilizers increases the risk of infections. This risk can be reduced by composting the manure before use.

One of the main disadvantages of organic fertilizers is their bulk, which causes high transportation and labour costs. Often special facilities where the manure can be stored have to be constructed.

If *Artemia* ponds are converted to shrimp ponds, all organic waste accumulated at the bottom has to be removed. This is also an expensive and labour intensive job.

COMBINATION OF ORGANIC AND INORGANIC FERTILIZERS

A common practice is to use a combination of inorganic and organic fertilizers. While inorganic fertilizers stimulate algae growth and mineralization of the organic fertilizer (lower C:N ratio), the organic fertilizer is used as direct food for the *Artemia* and via slow release of nutrients, especially phosphorus further stimulates algae growth.

Normally inorganic fertilizers are added to the fertilization ponds or canals, while manure can be added directly to the *Artemia* culture ponds or to the fertilization ponds. If possible, salinity in the fertilization ponds should be kept above 50 g.l⁻¹. At this salinity blue green algae (most of which can not be taken up by *Artemia*) will be outcompeted by more suitable green algae and diatoms. As discussed earlier fertilization ponds - which are per definition heavily fertilized - should be deep (preferably more than 0.7 m) to prevent the development of benthic algae.

4.5.5. *Artemia* inoculation

4.5.5.1. *Artemia* strain selection

The introduction of a foreign *Artemia* strain should be considered very carefully, especially in those habitats where it will result in the establishment of a permanent population as in the salt works in NE Brazil. In such cases the suitability of the strain for use in aquaculture especially with regard to its cysts characteristics, will be a determining factor.

When the idea is to replace a poor performing strain, in terms of its limited effect on algae removal in the salt production process, or its unsuitable characteristics for use in aquaculture (e.g. large cysts, particular diapause or hatching characteristics) all possible efforts should be made to collect, process and store a sufficient quantity of good hatching cysts. Samples should be sent to the *Artemia* Reference Center for preservation of this genepool of *Artemia* in the *Artemia* cyst bank.

As mentioned earlier *Artemia* strains differ widely in ecological tolerance ranges and characteristics for use in aquaculture. Therefore, the selection of the strain best adapted to the particular ecological conditions of the site and/or most suitable for its later application in aquaculture is very important.

Strain selection can be based on the literature data for growth, reproductive characteristics and especially temperature/salinity tolerance. Summarizing, a strain exhibiting maximal growth and having a high reproductive output at the prevailing temperature/salinity regime in the ponds should be selected. Usually strains producing small cysts and nauplii are to be preferred unless production of biomass is the main objective. In the latter case selecting a fast growing strain having a dominant ovoviviparous reproduction is recommended.

If a local strain is present, one should be sure that the newly-introduced strain can outcompete this local one. The strain with the highest number of offspring under the local environmental conditions will eventually outcompete the other. However, initial population density also plays an important role (most abundant strain often wins). Therefore the new strain should be introduced at a moment when density of the local strain is at its lowest point.

4.5.5.2. Inoculation procedures

HATCHING PROCEDURES

Standard procedures as described under 4.2.5. should be followed as much as possible. As hatching conditions under field situations are often suboptimal, the following directions should at least be observed:

- Hatching containers should be placed in shaded areas to prevent excessive heating by direct sunlight.
- Water should be filtered, preferably using a 1 μ m filter bag (GAF).
- If water remains turbid after filtration, lower the salinity to 20 g.l⁻¹ and add no more than 1 g cysts.l⁻¹ to the hatching containers.
- Provide sufficient aeration and illumination, especially when cysts are incubated in late afternoon or evening.

The quantity of cysts needed to obtain the number of nauplii required for inoculation (and taking into account a 30% mortality at the time of stocking) is calculated from the pond volume and the hatching efficiency of the selected batch. Take into account that as hatching is suboptimal, the hatching percent might be lower than expected (often only 75%).

STOCKING PROCEDURES

It is essential to harvest the nauplii in the first instar stage. Older instar stages, will not survive the salinity shock as well when transferred from the hatching vessel (20 g.l⁻¹ to 35 g.l⁻¹) to the culture ponds (80 g.l⁻¹ upwards). Therefore, regular checks through subsampling of the hatching containers is recommended.

Stocking density is determined by the nutrient level and temperature found in the culture ponds. We give the following recommendations:

- large salt operations

Depending on the size of the ponds a stocking density of 5 - 10 nauplii.l⁻¹ should be considered. However in large operations practical considerations such as facilities to hatch out the required amount of cysts might further limit the stocking density.

Animals should be stocked as early as possible in the brine circuit where no predators are found. Downstream ponds at higher salinity need not necessarily be inoculated since they will be stocked gradually with *Artemia* drained from the inoculated ponds. When algae blooms are a problem, stocking of several ponds might be needed.

- Small pond systems

The initial stocking density can be as high as 100 nauplii.l⁻¹ in ponds with a turbidity between 15 and 25 cm. However, at such high stocking densities oxygen might become limiting, especially when water temperatures are high. At lower turbidity (less than 25 cm) stocking density should be decreased to 50 to 70 nauplii.l⁻¹.

Stocking at high density is thought to stimulate oviparous reproduction. However, if initial stocking density is high, animals will grow more slowly due to food limitations. In extreme cases the brine shrimp will even starve before reaching maturity. Also, at high temperatures oxygen depletions further interfere with growth and reproduction.

Stocking at lower density might increase the proportion of females in ovoviviparous mode of reproduction. But as more food is available per individual animals grow faster and females have larger broods. As a result, final cyst yields do not necessarily decrease when lower stocking densities are applied.

4.5.6. Monitoring and managing the culture system

Very regular monitoring of the ponds is necessary to allow correct management. The type of sampling program largely depends on the goals. If production is the main objective only those variables necessary to provide essential decision-making information should be followed (temperature, salinity, turbidity, number of females and brood size). On the other hand more extensive sampling programs will be needed when research programs are carried out in the culture ponds, allowing at least for relative estimates of population numbers.

The most important rule when collecting data is standardization! Select fixed sampling stations at every site and mark them. Use always the same (well-maintained and operational) equipment and (correct) technique when measuring a certain parameter or when analyzing samples. Keep careful records of your data.

In Fig. 4.5.7. we give a flow chart of a possible monitoring and managing program for large salt operations. In Fig. 4.5.8. we give a flow-chart, showing management in a smaller unit. As no two sites are identical, these flow-charts should only be considered as guidelines.

In the following paragraphs we will discuss the most important environmental parameters. For each parameter we give measurement procedures, discuss their effects on the *Artemia* population and, where possible, explain how to manipulate them.

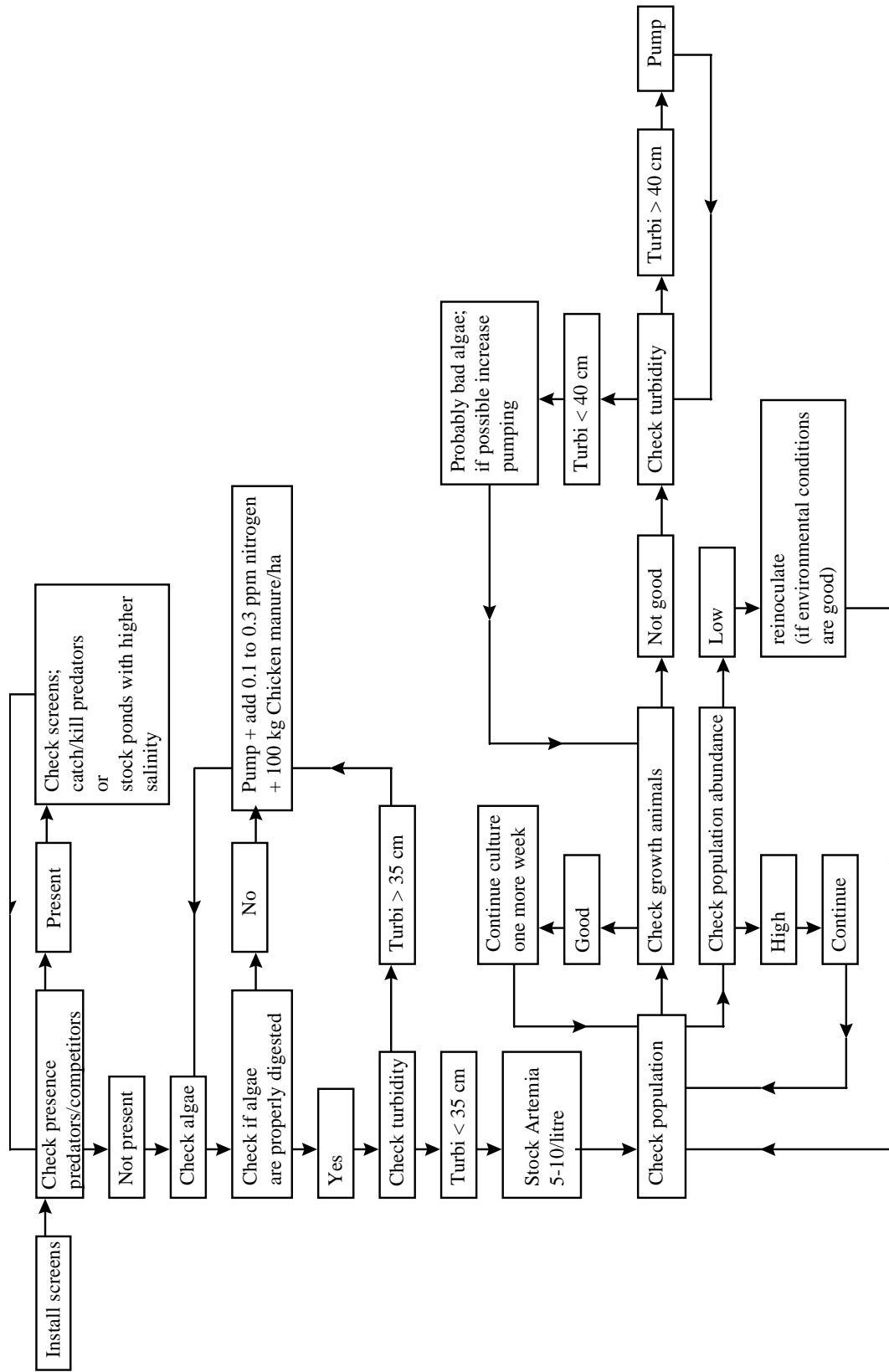

Figure 4.5.7. Flow chart of a possible monitoring and managing program for large salt operations.

4.5.6.1. Monitoring the *Artemia* population

For production purposes the following procedure is recommended.

Twice a week samples (e.g. 10 samples.ha⁻¹) are collected in the different culture ponds. Samples should be collected at fixed sampling stations located in as many different strata as possible.

A habitat can be divided in different strata, each stratum having slightly different environmental characteristics and consequently different *Artemia* densities (e.g. in a pond with a peripheral ditch - the platform, the ditch and the corners - can be considered as three different strata as temperature and algae abundance differ at these three places). This way the risk of not finding *Artemia*, although present in the pond, is reduced. The following two sampling methods can be recommended:

- Per sample site 5 -10 l water is filtered over a sieve (100 µm).
- A conical net is dragged over a certain distance through the water. Drags can be horizontal or vertical. However, mesh size and diameter of the sampling net depends on the volume of water sampled, which in turn depends on the population density in the pond. If population density is high, nets with a diameter of 30 - 50 cm and mesh size of 100 µm can be used. In large ponds where population density is low, larger nets (diameter up to 1 m) are dragged over a longer distance. To prevent clogging, only the distal part of the net has a small mesh size (100 µm).

The remainder of the net can have a mesh size of 300 - 500 µm.

Samples are fixed with formalin and carefully examined, dividing animals in three groups, nauplii (no thoracopods), juveniles (developing thoracopods clearly visible) and adults (sexual differentiation apparent). The relative presence of each life stage is given a score as follows:

0 = not present.

1 = few individuals present

2 = present

3 = dominant in the sample (large clouds of *Artemia* are observed in the ponds)

The scores for each life stage of all samples taken in one pond are summed and plotted in time. Although such estimates are not accurate (do not give the exact number of animals per liter), they are precise (reflect correctly the variations in abundance). Such curves (Fig. 4.5.9.) show how a population evolves and allow for adaptation of the management procedures (see Fig 4.5.7. and Fig. 4.5.8.).

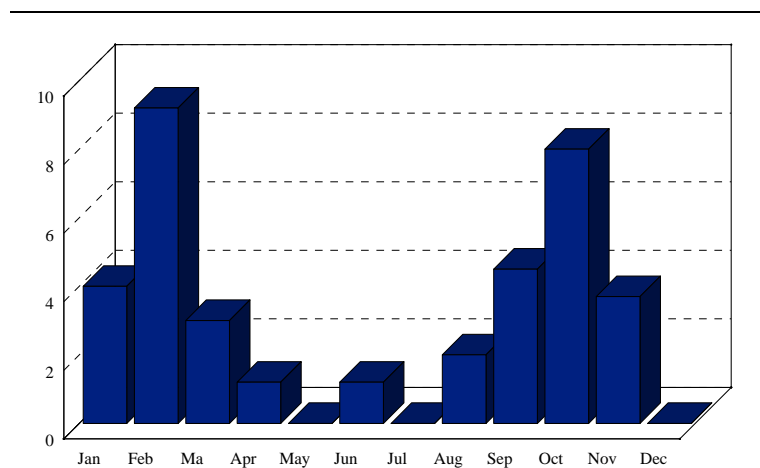

Figure 4.5.9. Population evaluation curves.

Apart from population composition, the reproductive status of the females can also be used as an indicator for the health status of the *Artemia* population. Large broods, and short retention times between broods (e.g. females having both developing ovary and filled uterus) show that pond conditions are good.

Finally, the following characteristics also give additional information on the health status of the population:

- Are the guts of the animals completely filled with an amorph mass, especially in the morning (control under microscope)? If guts are only partly filled, animals are underfed.
- Are the faecal pellets well filled? Keep some animals in a jar filled with pond water and collect pellets from the bottom. Check pellets under a microscope. Are the pellets short or do animals tail long pellets? If tailing pellets are observed together with only partly filled pellets, animals are underfed. If tailing pellets are observed, but pellets and guts are well filled, food is not digested properly, which can be due to overfeeding or the presence of unsuitable algae.
- Swimming behaviour of the animals. Do they form clusters? Do they swim quickly/continuously? If not, animals are stressed.

When conducting research, populations should be estimated more accurately. The following guidelines might be helpful:

- Standardize your sampling method. Take samples always at the same spot, the same way, the same time of day using the same sampling equipment.
- Check the distribution pattern of your population at different times of the day. Often populations are more homogeneously distributed early in the morning and at night. Taking samples at this moment will reduce variation between pond samples. Variation can of course also be reduced via sampling only one or two strata (i.e. strata where highest number of animals are found). This might give a precise estimate, but note that the estimate is certainly inaccurate.

- Taking bigger samples reduces the variance. Therefore, transects taken with a trawl net give more precise estimates than point samples. Also, when taking sufficiently long transects, more strata are included in the sampling program.
- When subsampling your samples, make sure your subsamples contain between 50 and 150 animals (cf. adapt your dilution factor). In smaller subsamples the coefficient of variance increases, while the risk of counting errors increases with larger sample size. Also, take enough subsamples per sample (at least three). As for the samples, standardize methodology.
- A quick way to estimate standing crop is to use sample volume as an estimate. After fixing the sample with lugol or formalin, biomass is transferred to a measuring cylinder, where it is allowed to settle for 10 min after which the volume is read. As sample volume can be determined quickly, increasing the number of samples per pond is possible. Dirt present in the sample or salt sticking to the animals has only a minor impact on sample volume. This is not true for dry weight. Using dry weight as an estimator is only possible if samples can be cleaned properly, which is a time consuming activity. Wet weight should not be used as it is very unprecise and inaccurate. Of course sample volume depends both on animal abundance and animal size. As both cyst production and biomass production mainly depend on the number of large animals, volume usually reflects correctly the status of the population.
- If the aim of the study is to predict cyst production, both sample volume and female abundance are good predictors.

4.5.6.2. Abiotic parameters influencing *Artemia* populations

TEMPERATURE

Temperature can be measured with a glass thermometer. The thermometer has to be read while still submerged in the water, otherwise recorded values will be lowered due to evaporation on the measuring bulb.

In deeper ponds, the water may be stratified and the temperatures at the surface and bottom may differ considerably. In extreme situations this can lead to lethally high temperatures and low oxygen concentrations at the pond bottom, especially in situations of salinity stratification (i.e. green-house effect resulting from the low saline top layer). Such situation, indicated by surfacing of large clouds of *Artemia* and animals of a dark red color, has a negative influence on growth and survival. Regular pumping or raking of the pond bottom will prevent stratification.

SALINITY

Salinity is best measured with a refractometer, which can be corrected for different temperatures. As algal concentration and other suspended materials influence the refractive index, it is recommended to filter the sample before measurement.

Salinity is important in setting the lower and upper limit between which *Artemia* can thrive. As mentioned before, the upper salinity tolerance level of predators (fish, Corixidae) determines from which salinity onwards reasonable numbers of *Artemia* can be found. At too high salinity (> 250 g.l⁻¹) water becomes toxic for *Artemia*. Under field conditions, oviparous reproduction is often found at high salinity. The lower oxygen concentration at high salinity (oxygen stress) and often low algae density (food stress) in salt works might explain this. Both oxygen stress and food stress have been mentioned as factors stimulating oviparous reproduction.

However, an alternative explanation would be that females carrying nauplii and cysts are carried by water currents to the ponds located at the end of the system. We noted that the animal abundance in these ponds is usually much higher than in previous ponds. Furthermore, when working in static systems, cyst production does not increase with salinity. In addition, food stress can negatively influence brood size and if continued for long periods (one week) can lead to a significant decrease in cyst yields.

Salinity can be manipulated through pumping. The salinity of the pond water after pumping can be calculated using the following formula:

$$S_{\text{end}} = [V_1 \cdot S_1 + V_2 \cdot S_2] \cdot [V_1 + V_2]^{-1}$$

S_{end} = salinity in the pond after pumping.

$V_1; S_1$ = volume; salinity in the pond before pumping

$V_2; S_2$ = volume; salinity of the water pumped in the pond

OXYGEN

Oxygen is measured with a portable oxygen-meter. As oxygen levels change very quickly once the sample is taken, this parameter should be measured immediately after collection of the sample or best in the pond. While measuring, the probe should be moved constantly.

Often oxygen levels will be higher at the surface than at the bottom especially when ponds are stratified. Oxygen levels also exhibit daily cycles. Concentrations are the lowest at dawn (algal respiration) and the highest in the afternoon (algal photo-synthesis). If problems with oxygen are anticipated, measurements should be made at dawn.

As oxygen meters are very expensive and difficult to maintain, they should be used only if specific research studies on the effects of oxygen are conducted. The color and behavior of the *Artemia* will indicate when the animals are experiencing an oxygen stress (i.e. animals turn red, swim slowly, start surfacing and growth is retarded).

Additional pumping, lowering the algae concentration or circulating the water in the pond will increase oxygen levels. Finally we note that oxygen stress has also been mentioned as a factor inducing oviparous reproduction, although results are not always unequivocal. In the field prolonged oxygen stresses usually result in poor growth, reduced reproductive output and mortality.

pH

pH is measured with a portable pH-meter. Meters should be properly calibrated before use. A cheap alternative, with acceptable accuracy for most purposes, is the use of pH paper.

In their natural habitat *Artemia* are mostly found in a pH range between 7.8 and 8.2, which is often given as the optimal range. However, the effects of pH on growth and reproduction have not been studied so far. Moreover, some *Artemia* populations can be found in alkaline lakes, having a pH between 9 and 10 (i.e. Mono Lake, California, USA; Wadi Natrun, Egypt).

Algae blooms can affect the pH (consumption of CO₂). In general, the highest pH is reached in the afternoon while the lowest pH occurs near dawn. As sea water is usually well buffered, problems with pH are rare, except in areas with acid sulfate soils (see 4.5.4.1).

WATER DEPTH

Depth is best measured using calibrated sticks positioned in the pond. This is an important parameter to be recorded since it also has an effect on other measurements (such as temperature and oxygen). Furthermore, fluctuations in pond depth give information on pumping rates, evaporation, precipitation and leakage.

4.5.6.3. Biotic factors influencing *Artemia* populations

ALGAE

The easiest way to estimate algae abundance is through the measurement of turbidity, which can be readily measured using a Secchi disk (Fig. 4.5.10). The disk is lowered in the water up to the point where the contrast between the white and black (or red) fields disappears, and the depth recorded. After lowering the disk a little more, it is then brought up slowly until the contrast is again visible and this depth is then also recorded; the average of both of the recorded depths being the turbidity. The turbidity also fluctuates during the day and is generally highest in the afternoon. Note that wind (concentration of algae in the down wind corners) as well as suspended solids (e.g. clay) can affect turbidity readings. Turbidity readings between 25 and 35 cm are optimal. At lower turbidity levels, extra pumping of nutrient rich water is needed (see 4.5.4.2). At higher turbidity, there is an increased risk of oxygen depletion at dawn.

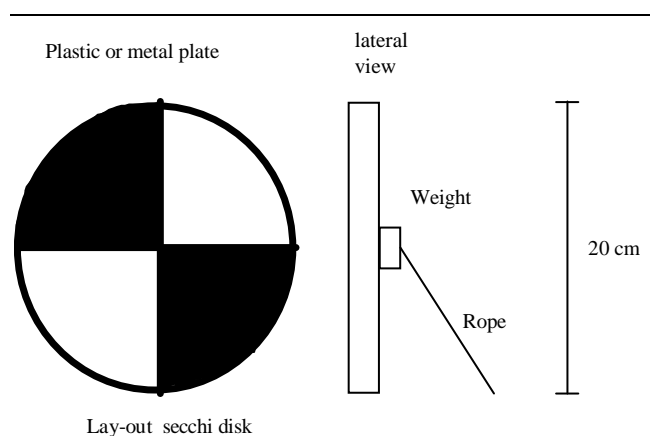

Figure 4.5.10. Secchi disk.

If time and equipment are available, algal density can also be estimated by analysis of the chlorophyll concentration. However, this method is only valid if combined with a proper sampling program. We refer the interested reader to specialized literature on this subject. As algae populations are seldom homogeneously distributed over the pond, recommendations as given for *Artemia* should be followed (see 4.5.6.9).

The color of the water can give useful indications concerning the type of organisms present in the culture ponds. For practical recommendations in the field see Table 4.5.5. Of course if problems are encountered, more thorough analysis of the algae samples is recommended. Algae composition does not only influence growth and reproduction of the *Artemia*, but also has an effect on the nutritional value of the biomass and the cysts (e.g. fatty acid composition). Algae numbers can be increased through fertilization (see 4.5.4.2).

A problem often encountered in *Artemia* ponds is the presence of benthic and/or filamentous algae. Both types of algae are unsuitable as food for the *Artemia*. Development of these algae can be prevented by keeping pond water turbid and deepening the ponds.

Table 4.5.5. Recommendations concerning the type of organisms.

Colour	Types of organism expected
Clear	Few organisms present/low nutrient level.
Grey/white	High amount of suspended matter, probably clay/gypsum.
Green	Algae, probably green algae. When familiar with the site, different shades of green can be associated with different green algae.
	Algae, possibly diatoms.
Brown	If combined with high salinity, <i>Dunalliella sp</i> or <i>Halobacterium sp</i> .
Red	



Figure 4.5.11. Raking the *Artemia* pond in order to remove the benthic algae.

In Viet Nam, pond bottoms are raked daily, for removal of the benthic algae (Fig. 4.5.11.). Moreover, raking brings detritus (extra food for *Artemia*) as well as inorganic nutrients back into suspension. Similarly, soft pond bottoms appear to reduce the amount of benthic algae developing in the pond.

If filamentous algae develop in the pond, they spread very quickly, finally interfering with cyst collection (i.e. the cysts being trapped in the filaments). To date, the only method used to reduce the amount of filamentous algae is by manual removal and raking, which is of course very labour intensive.

PREDATORS AND COMPETITORS

The abundance of predators and competitors can be estimated by using similar techniques to those discussed for *Artemia*. Possible predators include fish (*Aphanius*, *Tilapia*), various species of insects (*Corixidae*) and some copepods. Rotifers and ciliates (*Fabrea*) are also possible food competitors. As mentioned in the previous chapters, careful screening of the intake waters and increasing salinity will keep their numbers within acceptable limits. As wading waterbirds (i.e. avocets and herons) also consume adult *Artemia*, bird scarers and wires stretched above the water near shallow places can help keep these predators away.

4.5.7. Harvesting and processing techniques

4.5.7.1. *Artemia* biomass harvesting and processing

HARVESTING STEP

Adult *Artemia* biomass can be collected from large shallow ponds with conical nets mounted in front of a motor boat or pulled by manpower (Figure 4.5.12 and 4.5.13);

see also chapter 5.1. In small ponds dip-nets can be used. Alternatively nets can be installed (temporarily) at the pond outlet and biomass is then collected automatically when water flows (by pumping or gravity) to the next pond (Figure 4.5.14). The following are some general guidelines for *Artemia* biomass harvesting:



Figure 4.5.12. Raft with conical net used for *Artemia* biomass harvesting.

- nets should be large to facilitate harvesting, e.g. for 100 kg of adult biomass use a filter mouth of 1 by 2 m and a filter length of 3 to 6 m
- use mesh size of 1 to 2 mm for selective harvesting of adults/juveniles
- fit mesh of 100 μm to the end of the net where adults accumulate so as to prevent

extrusion of the animals.



Figure 4.5.13. Small net used for *Artemia* biomass harvesting.



Figure 4.5.14. Installation of filter nets at the sluice gate for *Artemia* biomass harvesting in solar saltworks.

- empty nets every hour; *Artemia* biomass accumulating at the end of the filter sac is exposed to anaerobic conditions which it can tolerate for up to 1 h; since *Artemia* is rich in proteolytic enzymes it is essential to harvest them alive.
- after collection, biomass should be prepared for transport and further use or treatment.

PROCESSING STEP

Use one of the following methods according to the needs:

- immediate use within 1 to 3 h as live food or for freezing/drying (>90% survival)
 - store harvested biomass temporarily in nets installed in the pond (Figure 4.5.16)
 - apply strong aeration in nets
 - rinse biomass with seawater
 - transfer rinsed biomass to containers with seawater at a density of maximum 500 g wet weight biomass per liter of sea water
 - use ice (mixed with biomass) to cool biomass to 5-10°C
 - apply strong aeration
- use within 12 h as a live food or for freezing/drying (>90% survival)
 - same procedure as for a/ but store at maximum 300 g wet weight biomass per liter of sea water.
- live transport for marketing as a live product (>90% survival after 24 h)
 - transfer harvested biomass into nets installed in the pond
 - apply strong aeration
 - rinse biomass with sea water
 - use similar technique as for transport of live fish/shrimp larvae *i.e.*:
 - prepare 9 l plastic bags, seawater, oxygen bottle
 - fill bags with 2 to 3 l seawater

- add *Artemia* at a density of 100 g live wet weight biomass per liter
- inflate rest of the bag with oxygen and close off with rubber band
- pack bags in styrofoam boxes filled with ice (Figure 4.5.15)

Following harvesting and transport, *Artemia* biomass can be frozen for subsequent use as a food source in fish/shrimp hatcheries or for the pet market. Alternatively, biomass can be dried and used as an ingredient for larval feeds (flakes or particulate diets). Keep in mind the following:

- Since *Artemia* is rich in proteolytic enzymes it is essential to process the biomass alive.
- Freeze as fast as possible (thin layers, low temperature), slow freezing will result in proteolytic activity and leaching of essential nutrients when used subsequently.
- If dried slowly (e.g. sun drying) excessive oxidation occurs (black coloring) and proteolytic activity will result in product losses.
- Best quality biomass meal is obtained with freeze drying or spray drying.
- Acceptable quality can be obtained with drum drying (flaking).
- For economical feasibility consider a weight loss of 90% (*Artemia* biomass contains about 90% water) when drying *Artemia* biomass.

For detailed use of above mentioned drying/freezing techniques, we refer the user to specialized text books on food processing.

Bags with ice

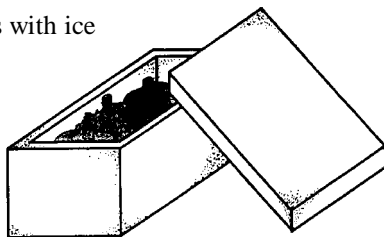

Inflated with compressed air or oxygen 2/3 of total volume.

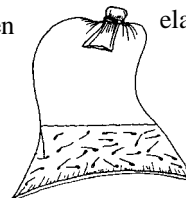

Top of bag twisted, turned over and fastened tightly with elastic band.

Water : 1/3 of total volume.

Figure 4.5.15. Live *Artemia* transport bag and a transport styrofoam box containing several bags and ice.



Figure 4.5.16. Storage net for *Artemia* biomass harvested from seasonal salt ponds integrated for *Artemia* production.

4.5.7.2. *Artemia* cyst harvesting and processing

Once the cysts are harvested, a number of processing steps should be carried out in order to obtain a clean, marketable product featuring acceptable hatching parameters and shelf life.

As can be seen in Figure 4.5.17 the processing can be divided into seven consecutive processing steps, namely harvesting, brine processing, freshwater processing, drying, prepackaging, packaging and dry storage.

Each processing step involves several processing activities and these are shown in Figure 4.5.17.

Freshly-released cysts do not immediately develop into nauplii, even when the incubation conditions in the habitat are favorable. These cysts remain in a state of diapause which means that all metabolic activity is reversibly interrupted. Only after deactivation of this diapause can the cysts resume their development when incubated under acceptable hatching conditions (see also chapter 4.2.1.4.). An overview of strain/batch-specific diapause deactivation techniques which can be applied during certain processing steps/activities or which may interact with certain processing steps/activities are given in the column “diapause deactivation” of Figure 4.5.17 and will be further discussed at the end of this chapter.

Throughout the processing, rigorous quality control will have to be implemented in order to adjust or correct the processing techniques when required and obtain a final product of good marketable quality. For quality analysis of *Artemia* cysts we refer the reader to chapter 4.2.5.2. We advise the user to review this chapter as reference to several hatching parameters will be made throughout this chapter. Finally, the user will choose a combination of processing steps/activities and diapause deactivation techniques which will largely depend on:

- trade off between required final quality and economic feasibility
- strain/batch specific characteristics
- local conditions (i.e. site location, storage facilities, local equipment available, scale of operation)

HARVESTING STEP

After being released, cysts float on the water surface and are gradually washed ashore by winds and waves. In places with changing wind direction, cysts may be carried around for a long period before they are thrown ashore. If these cysts are produced in low saline ponds (<100 ppt) or when salinity stratification takes place after rainfall, quiescent cysts may hatch. When water is very agitated and much foam develops, cysts get trapped and lost in the airborne foam. On the other hand, cysts which are washed ashore may be exposed to high temperatures, UV radiation and repeated hydration/dehydration cycles which in turn may decrease the viability of the final product. Furthermore, these cysts may also become airborne when dry.

Maximum guarantee for good quality and at the same time reduced contamination with impurities are ensured when cysts are harvested from the water surface on a regular basis. Worksheet 4.5.1. summarizes pond modifications and collection procedures which may help to improve cyst harvesting and quality.

BRINE PROCESSING STEP

The different brine processing activities and their respective aims are listed in Figure 4.5.17. Each activity and the possible interactions or combination with other processing activities is shortly described below (see also worksheet 4.5.2.).

- Brine dehydration:

In order to improve storage conditions and/or to deactivate diapause (see also raw storage and diapause deactivation), cysts are usually dehydrated (to a water content of 20 to 25%) in saturated brine immediately after harvesting. When size and density separation equipment is located near the collection sites, brine dehydration is

either combined with or performed immediately after density separation and size separation (see below). However, when there is a long period (up to several weeks) between collection and further processing it is advisable to perform brine dehydration before size and density separation in brine so as to avoid quality decrease.

- Size separation in brine:

This involves the removal of debris larger and smaller than the cysts (i.e. feathers, sand, wood, stones) by screening the harvested product over different mesh sizes (i.e. 1 mm, 0.5 mm, 0.15 mm). For cyst material containing a lot of heavy debris (when collected from the shore), it is more efficient to perform a density separation in brine (see below) prior to size separation.

- Density separation in brine:

Removal of heavy debris in the same size range as the cysts (when performed subsequent to size separation) is carried out through density separation in brine. Cysts submerged in brine float, while heavy debris (i.e. sand, small stones, heavy organic matter) sink. Density separation is often performed near production sites (due to availability of saturated brine) soon after harvesting. It can be combined with brine dehydration or the cysts can be transferred to a special brine dehydration tank or pond subsequently to density separation.

- Raw storage:

The reasons for raw storage are usually a combination of the following:

- temporary storage (days or weeks) before the next brine processing activity,
 - i.e. - when the processing site is located far from the collection site
 - when the amount collected is too small to process on a daily basis
 - in-between different brine processing activities
- temporary storage before the freshwater processing step
- combination of raw storage and specific diapause deactivation methods
- raw storage for use as a wet-dry product (within 2 to 3 months)

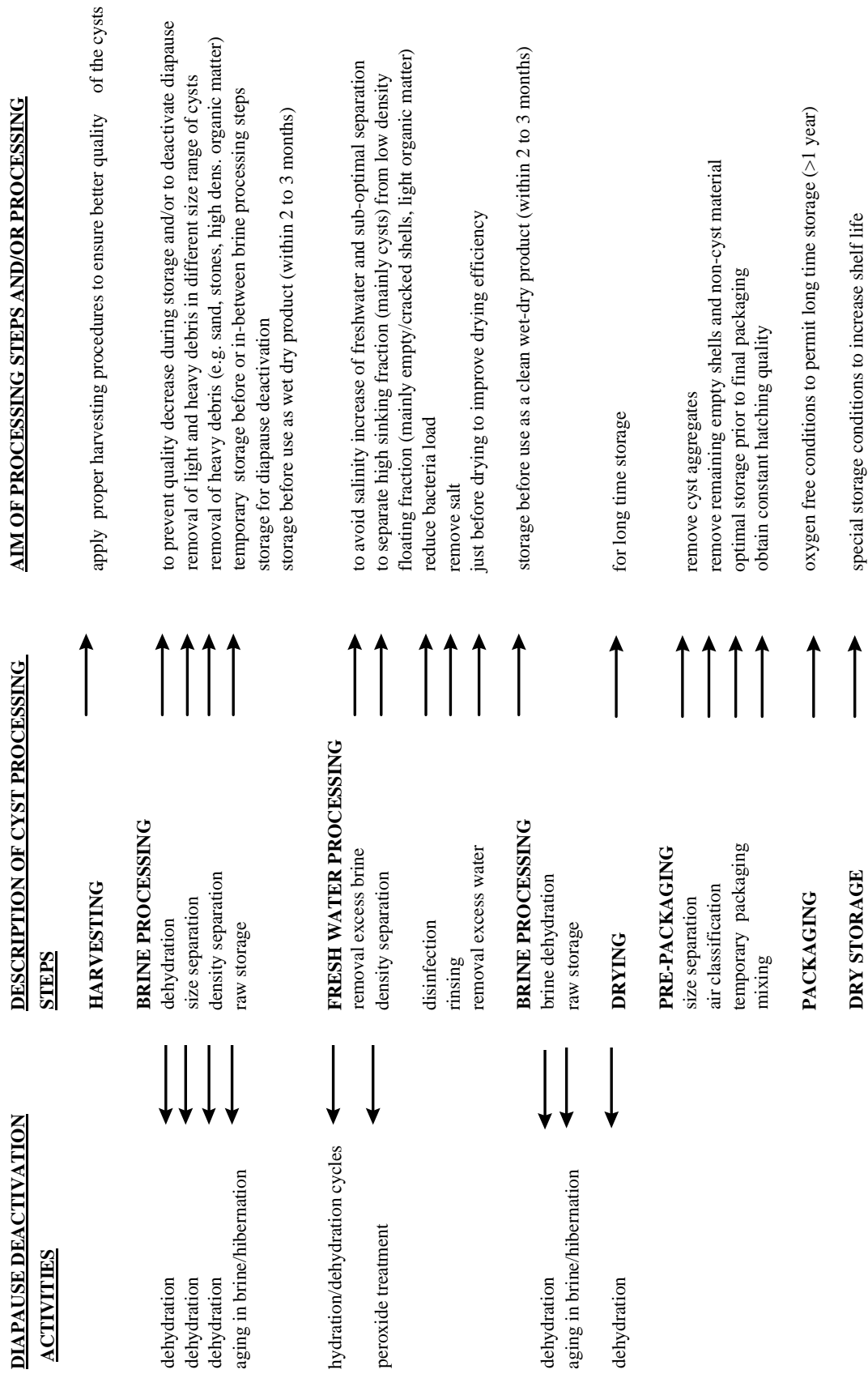

Figure 4.5.17. Overview of cyst processing (Modified from Lavens and Sorgeloos, 1987).

The following are a number of methods for raw storage, including comments on the optimal storage period, strain/batch specific aspects and interaction with other processing techniques:

a) Storage in low-saline brine (i.e. pond brine):

Many strains can be stored in pond brine with a salinity as low as 100 ppt for several days at ambient temperature without a decrease in viability. When stored in low-saline brine, it is essential for the cysts to remain under hypoxic conditions to prevent initiation of the hatching metabolism. Hypoxic conditions can be obtained when stored at a relatively high ratio of cysts to brine (20 to 80% volume/volume) without aeration. In certain cases cysts have been safely stored in salinities as low as 80 g.l⁻¹ for up to 2 months at ambient temperature under hypoxic conditions during which diapause is slowly deactivated (see also diapause deactivation methods). Storage in pond brine under hypoxic conditions for several days is often used as a temporary storage method between harvesting and further brine processing.

b) Storage in saturated brine:

After brine dehydration cysts can be stored safely for up to 1 month (some times for several months) at ambient temperature. The cysts can be stored in containers submerged in brine or alternatively, excess brine can be removed (i.e. by hand squeezing) and the semi-moist product can be stored in bags made of cotton or jute; the remaining brine will further leak from the bags during storage. When stored as a semi-moist product over longer periods (>1 week), in areas of high relative humidity, crude salt should be mixed with the cysts as to prevent the rehydration of the highly hygroscopic cysts. Storage in hypoxic conditions (in brine, 20 to 80% cysts volume/volume, no aeration) or with ample oxygen availability (as a semi-moist product) seems to have little influence on the optimal storage time provided the cysts are properly dehydrated. Eventually, the cysts should be stored in bags if transported over large distances (easy to handle, less weight). Apart from diapause deactivation as a result of the dehydration process itself, the storage (aging) in brine may further deactivate the diapause in certain strains/batches.

c) Cold storage:

Many cyst strains/batches may be stored for several months up to a year at temperatures between -20 and 4°C. For certain cyst species/strains, cold storage for several months is an adequate diapause deactivation method (see also specific diapause deactivation techniques). Due to the high costs involved and the limited availability of cold stores near the harvesting sites, cold storage should only be considered when this specific diapause deactivation method is needed. Although many strains/batches have been stored safely without proper dehydration, cysts are usually dehydrated in saturated brine and packed as a wet-dry product prior to cold storage.

d) Use as a semi-moist product:

Cysts stored in saturated brine, may be used as a partially-cleaned semi-moist product within 2 to 3 months after harvesting. After 2 to 3 months of brine storage, the hatching percentage usually decreases (see Table 4.5.6). If required, a clean semi-moist cyst product can be obtained by applying a fresh water processing step.

FRESHWATER PROCESSING STEP

During the freshwater processing step, the cyst material is further cleaned through density separation and prepared for subsequent drying. As freshwater is used, the cysts will partially hydrate. If the cysts remain hydrated for too long a period under aerated conditions, the embryos will eventually reach an irreversible state of the hatching metabolism (*i.e.* cysts cannot be dehydrated without affecting the viability of the embryos). The exact time at which this irreversible state is achieved, is largely strain/batch specific but may be as short as 6 h. Even when cysts are dehydrated before reaching the irreversible phase of metabolism, their energy reserves may have been depleted to levels which result in a decrease of hatchability. To prevent prolonged metabolism and consequent depletion of energy reserves, freshwater processing should be limited to a maximum of 30 minutes. The different activities in the freshwater processing step are briefly discussed below, and the procedures given in worksheet 4.5.3.

- Removal of excess brine:

Before density separation in freshwater, excess brine must be removed in order to prevent salinity (density) increase of the water and consequently suboptimal separation.

- Density separation in freshwater:

Cyst material submerged in freshwater will separate into a high density (sinking) fraction and a low density (floating) fraction. The sinking fraction contains mainly full cysts and some non-cyst material of similar density and similar size as the full cysts. Some empty cysts and cracked shells remain in the sinking fraction and can be removed at a later stage by air classification (see further). The floating fraction contains mainly empty and cracked cysts shells and light density non-cyst material of a similar size range. With some cysts strains, the floating fraction can still contain a significant amount of full cysts featuring a relatively high hatching percentage (*i.e.* 50 to 80 %). However, because of the presence of empty shells and light non-cyst material, the hatching efficiency of this material is usually very low. When available, this cysts material can still be used as second grade product (eventually improved by air classification subsequent to drying; see pre-packaging).

- Disinfection:

To reduce the bacterial load of the final cyst product (reduce oxygen demand during hatching, reduce concentration of pathogens), the cysts can be disinfected during the freshwater treatment. This can be carried out by adding hypochlorite (liquid bleach) to the freshwater separation tanks prior to adding the cyst material. The concentration of active chlorine in the freshwater of the separation tanks should be less than 200 ppm.

- Rinsing:

If cysts are to be dried, they must be rinsed thoroughly with freshwater so as to avoid crystallization of the remaining salts during drying and consequent damage to the cyst shells. This rinsing can be carried out either before or after separation.

- Removal of excess water:

Following separation/rinsing and collection in bags, the bulk of the freshwater can be removed by firm squeezing of the cysts. The cysts can be dehydrated in saturated brine for raw storage and use (within 1 to 3 months) as a clean semi-moist product. Alternatively, the cysts can be dried (see drying) for long term storage. This should be carried out immediately in order to prevent further metabolism and decreased hatchability. If the cysts are to be dried, further removal of excess water (10 to 15 kg water per 100 kg wet cysts) can be achieved by centrifugation. This will reduce the stickiness of the product and facilitate the drying process. It will also significantly reduce the drying time and consequently the required energy inputs.

- Interaction with diapause deactivation:

Finally, rehydration and subsequent dehydration as a result of the freshwater processing step can in some cases further deactivate diapause in dormant cysts (see specific diapause deactivation techniques).

DRYING STEP

Depending on the drying procedure, the quality of the cysts (*i.e.* their hatching percentage and rate) can be affected the following factors must be considered when selecting a drying method:

- Final water content:

After freshwater treatment, the water content of the cysts should be reduced as soon as possible below the critical level of 10% in order to stop the metabolic activity and consequently ensure a long shelf life. Below a water content of 10%, little is known about the actual relation between water content and subsequent quality and shelf life. Usually a water content between 3 and 8% is aimed for.

- Optimal drying time:

With regard to the optimal drying time, best results are obtained when a water content of 10% is reached within 8 hours or less. Few data are available on possible quality

improvements when the drying time is very short (< 3h). Definitely, prolonged drying (i.e. > 24h) results in a decreased hatching percentage (possibly caused by a decrease of energy reserves).

- Drying temperature:

The maximal drying temperature is both strain specific and dependent upon the degree of dehydration of the cysts. For fully-hydrated cysts, temperatures below 35°C are usually safe. As the drying proceeds, water content decreases and cysts tend to be resistant to higher temperatures. If the freshwater processing cycle is limited to 45 minutes or less and excess water is properly removed, cysts are only partially hydrated (water content between 40 and 45%). Consequently they may resist higher temperatures (for some strains/batches up to 60°C).

- Homogenous drying:

It is important to ensure a homogenous drying process. Uneven drying will result in some cysts drying very slowly and eventually not reaching a water content of 10%. This may cause both a decrease in hatching percentage and hatching rate, and a reduced shelf life.

In summary, optimal results are obtained when ensuring a fast (< 8 h) and homogenous drying to a water content below 10% without exposing the cysts to critical temperatures. Depending upon the available equipment and financial resources, the following drying techniques can be applied:

- Layer drying in open air

Spread the cysts in thin layers of uniform thickness (few mm only) on a drying rack (trays made with 120 µm screen). Best spreading is obtained when using a 3 to 5 mm-mesh filter basket through which the semi-moist cysts are granulated. Place the trays under a roof in the open air and assure good air exchange (above and below the tray) for effective drying. Do not expose the cysts to direct sunlight as this may result in critical temperature increases within the cysts (through heat absorption by the dark shell) or in UV damaging of embryos (especially when dealing with pale cysts). Redistribute the cysts at repeated intervals (initially every hour) so as to ensure a more homogenous drying (cysts at the surface tend to dry faster as they are better exposed to air with lower humidity). Drying should be continued until constant weight, *i.e.* until a water content below 10% is reached. In climates/seasons of high humidity, this may be difficult. Indeed, the higher the relative humidity, the longer the drying time. Moreover, a final equilibrium will be reached (if dried for long enough) between the water content in the cysts and the relative humidity of the air. For example, at a relative humidity of 70 to 75% cysts may reach a water content of about 10 to 15% after a maximum of 48 h, and drying for a longer period will not result in a lower water content. However, to avoid rehydration of the highly hygroscopic cysts during the night (relative humidity increases as temperature decreases) the cysts should be stored in watertight containers overnight, and drying continued the following day if necessary.

Layer drying in open air is certainly the cheapest method requiring limited equipment. It may, however, be difficult to standardize the drying, especially in areas with high and/or highly fluctuating relative humidity. Poor standardization and slow drying may result in fluctuating cyst quality. Moreover, due to poor mixing, small aggregates (lumps) of cysts are formed which may affect the overall quality of the final product.

- Layer drying in oven

Place the drying racks in a temperature-controlled room or oven and assure a good air exchange. If possible fit a temperature control device to the heating system allowing a slow increase in temperature during the drying process (remember that as cysts get dryer, the temperature resistance increases). Heating air significantly decreases the relative humidity thus improving the drying e.g.: heating air with a relative humidity of 100% from 20 to 35°C will decrease the relative humidity to 45%. Always check the relation between temperature resistance and water content of the cysts you are using in order to find the most efficient temperature cycle and avoid overheating. This system offers better scope for standardization, especially if a temperature control device is fitted. However the drying may still be quite slow and the problem of cyst aggregates remains.

- Rotary drying

A faster and more homogenous drying is achieved when cysts are kept under continuous movement in a rotary dryer (e.g. 5 rpm). A schematic drawing of a rotary dryer is given in Figure 4.5.18. Continuous air flow through the drum is obtained with a ventilator fitted by means of an air duct to the inlet of the drum. A separate screened outlet allows discharge of humid air. Baffles are often used to improve mixing of the cysts. It is however better to fit a strong brush to the inside of the drum which rotates in the opposite direction of the drum. Besides functioning as a mixing device, it will prevent the cysts to stick to the sides of the drum thus reducing formation of aggregates. Again more efficient drying is achieved if a heater with temperature control device is fitted to the air inlet. Although more expensive, a well-designed rotary dryer will allow a faster, more homogenous and better standardized drying process as compared to layer drying and consequently a better quality cyst product will be obtained.

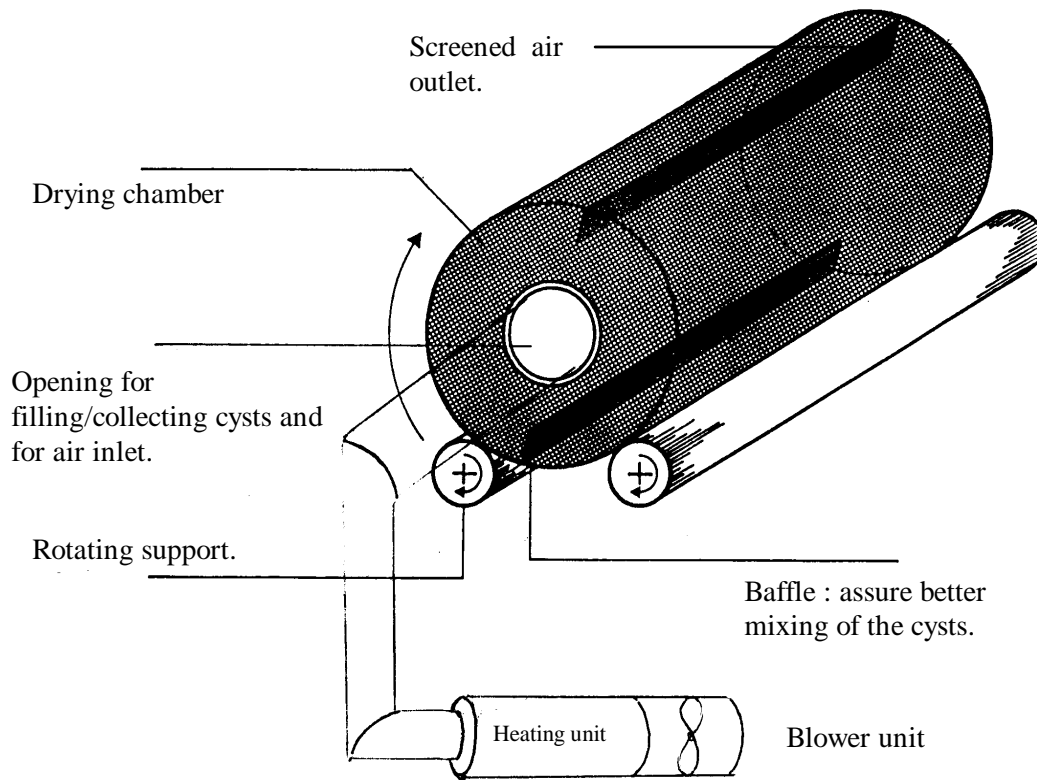

Figure 4.5.18. Schematic drawing of rotary dryer for *Artemia* cysts.

- Fluidized bed drying

The most efficient and most versatile drying is obtained by means of a fluidized bed drier (Figures 4.5.19 and 4.5.20). The basic design as outlined in Figure 4.5.19 consists of a conical drying chamber, a blower and a heating unit with temperature control device. The blower forces air over the heating unit into the drying chamber. A sieve at the inlet and outlet of the drying chamber allows free air flow without loss of air-suspended (fluidized cysts). The conical shape of the drying chamber ensures optimal mixing of the cyst product throughout the drying process which results in homogenous drying without excessive formation of cyst aggregations. Improved drying efficiency is further obtained by the heating unit. A first temperature sensor controls the inlet temperature (in certain cases as high as 90°C). Hot air which enters the drying chamber is immediately cooled down to temperatures below 35°C. As the cysts become dryer and more temperature resistant, evaporation decreases and the temperature in the drying chamber slowly increases. A second temperature sensor can be fitted inside the drying cone to avoid an increase of the cone temperature above critical levels (which are strain/batch-specific and should be tested) at the end of the drying process.

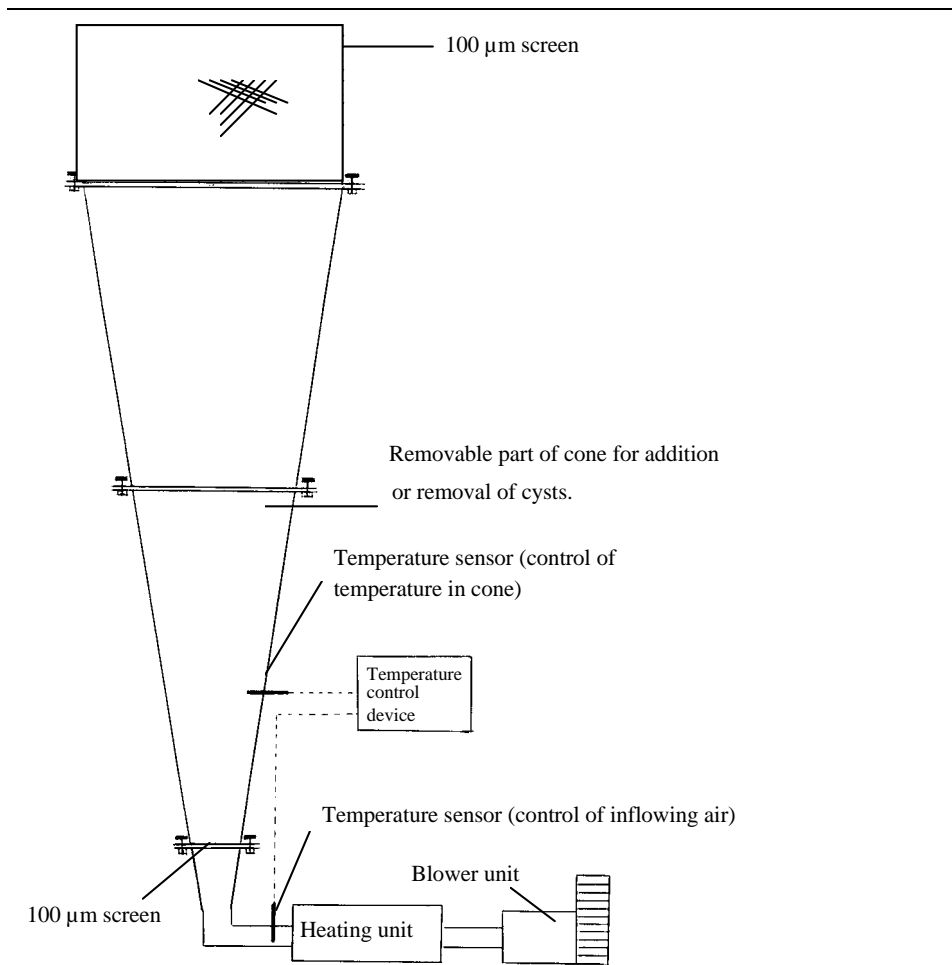

Figure 4.5.19. Schematic drawing of a fluidized bed dryer for *Artemia* cysts.

It is important to match blower capacity with cone dimensions and power of the heating unit. Although variations are possible, the following example can be used as a guide-line:

- blower characteristics :

- flow rate and working pressure: $280 \text{ m}^3 \cdot \text{h}^{-1}$ at 60 mbar
- maximal flow rate: 320 m^3 at 0 mbar
- maximal pressure: 200 mbar
- cone dimensions:
 - diameter top: 70 cm
 - diameter inlet: 14 cm
 - height (filling cone + top cone): 175 cm
 - height of filling cone: 95 cm (allows for 35 kg of wet cysts)
 - height of top screen: 40 cm
- power of the heating unit:
 - 6 to 9 kW depending on ambient temperature.

If the inlet and cone temperature are limited to respectively 80 and 40 °C, a unit with the above specifications will dry approximately 35 kg of wet cysts in less than 3 h to a water content below 10%. Increasing or decreasing one of the temperature settings will result in a decrease respectively increase of the drying time. In any case the specific temperature

tolerance of the strain/batch should be checked before applying the drying on a regular basis. Another advantage of the fluidized bed dryer is that it virtually eliminates the influence of the relative humidity of the inlet air (due to the high inlet temperature).

PRE-PACKAGING STEP

Immediately after drying, the cysts should be transferred to air-tight containers or sealed polyethylene bags in order to prevent rehydration of the highly hygroscopic cysts. Although some cyst strains can be temporarily stored at temperatures as high as 30°C for several weeks, other strains may require storage in a cooler environment (below 10 - 20°C).



Figure 4.5.20. A fluidized bed dryer for *Artemia* cysts.

During the drying (especially with layer and rotary drying) small aggregations of cysts are formed. Although this might not influence the hatching quality of the cysts, the aggregates can be removed by dry sieving to improve the visual appearance of the final product. Cyst aggregates can be rehydrated in saturated brine and re-processed at a later date, or used as a second quality product if the hatching percentage decreases.

Air classification is often applied to separate remaining empty and cracked shells which were not removed during freshwater separation. It can be done by releasing the dry material in a horizontal air stream in which heavy particles tend to fall down faster than light particles. E.g. cyst material blown through a horizontal air stream with several collecting vessels underneath will thus separate in subsequent heavy particles (remaining non-cyst material or cyst aggregates), full cysts, and finally empty shells, cracked shells and light non-cyst material. When significant amounts of full cysts are still present in the floating fraction of the freshwater separation, they can also be dried and then air classified to separate these cysts from the empty shells.

Finally, variations in hatching quality of the dry cysts (e.g. as a result of seasonal variations in cyst quality) may require mixing of different cyst batches in order to ensure a marketable product of constant quality. Any type of mixing equipment may be used providing cysts are not exposed to high humidity (to avoid rehydration). If available, a rotary type dryer can be used efficiently. The actual mixing process should take no longer than 5 to 10 min.

PACKAGING STEP AND STORAGE

Dry cysts should be packed in oxygen-free conditions as to prevent formation of free radicals (resulting in the irreversible interruption of the hatching metabolism). This can be done by vacuum or nitrogen packing. In order to ensure that the alveoles of the shell do not hold any more oxygen, nitrogen flushing should be repeated 2 or 3 times after vacuum treatment. Some examples of the effect of different storage conditions on the hatching percentage and hatching rate of *Artemia* cysts are given in Table 4.5.6, respectively Figure 4.5.21.

Once the dry cysts are properly packed (vacuum or nitrogen), they may be stored for months or even years without too much decrease in hatching. Besides being subject to the packaging conditions (air/vacuum/nitrogen), the shelf life of the dry cysts is strain/batch specific.

Although some strains may be stored at room temperature, storage temperatures below 10°C are usually recommended. Again, the optimal storage temperature is strain/batch specific.

Table 4.5.6. The effect of different storage conditions on the hatchability (in %) of *Artemia* cysts from two localities (after Vanhaecke and Sorgeloos, 1982).

Storage conditions	San Francisco Bay (Ca-USA) cysts - 1 year of storage	Macau (Brasil) cysts 2 years of storage
oxygen	70	56
air	-	83
nitrogen	100	91
vacuum	100	98
brine 20°C	66	74
brine -20°C	76	-

SPECIFIC DIAPAUSE DEACTIVATION TECHNIQUES

As explained in the introduction, cysts are usually released in a state of (endogeneously controlled) arrested metabolism called diapause. In order to obtain a product with acceptable hatching characteristics, this state of diapause must be deactivated. Often a combination of different strain/batch-specific deactivation techniques is required to obtain optimal hatchability. In some cases the hatchability can simply not be improved above a certain level. In such cases it cannot be determined if this is due to the effect of diapause or simply to the viability of the embryo. The most common diapause deactivating methods used are described in chapter 4.2.1.4. However, before implementing any of these techniques, they should be tested for effectiveness.

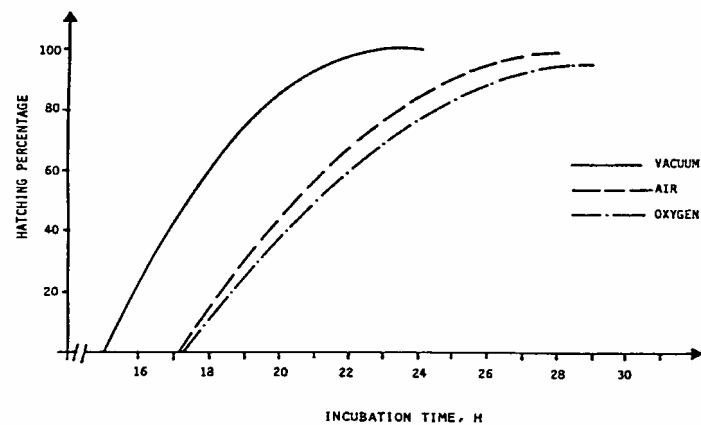

Figure 4.5.21. The effect of storage conditions on the hatching rate of *Artemia* cysts (after Vanhaecke and Sorgeloos, 1982).

4.5.8. Literature of interest

- Bosteels, T., Tackaert, W., Van Stappen, G. and Sorgeloos, P. 1996. Improved use of the fluidized bed dryer for *Artemia* cysts. *Aquaculture Eng.*, 15(3):169-179.
- Boyd, C.E. 1990. Water quality in ponds for aquaculture. Birmingham publishing Co., Birmingham. Alabama, USA. 482 pp.
- Clegg, J.S. and Cavagnaro, J. 1976. Interrelationships between water and cellular metabolism in *Artemia* cysts. IV. ATP and cyst hydration. *J. Biophys. Biochem. Cytol.* 88: 159-166.
- Drinkwater, L.E. and Clegg, J.S. 1991. Experimental biology of cyst diapause: 93-117. In: *Artemia Biology*. Browne R.A., P. Sorgeloos, and C.N.A. Trotman (Eds). CRC Press Inc., Boca Raton, Florida, USA, 374 pp.
- Eliot, J.M. 1977. Statistical analysis of samples of benthic invertebrates. *Freshwater Biol. Assoc.*, Scientific Publication No.25.
- Godeluck, B. 1980. Etude comparée des récoltes et traitements des oeufs d'*Artemia salina* des Salins du Midi en provenance de l'étang de Lavalduc. Thésis, Pierre et Marie Curie, Paris. 110 pp.
- Krebs, J.C. 1989. Ecological methodology. Harper & Row, Publishers, NY-USA, 654 pp.
- Kungvangkij, P. and Chua, T.E. 1986. Shrimp culture: pond design, operation and management. NACA training manual series No. 2. S. Sirikarnpimp, Bangkok, Thailand. 68pp.
- Lavens, P. and Sorgeloos, P. 1987. The cryptobiotic state of *Artemia* cysts, its diapause deactivation and hatching: 27-63. In: *Artemia Research and its Applications*. Vol. 3. Sorgeloos, P., Bengtson, D.A., Declair, W. and Jaspers, E. (Eds). Universa Press, Wetteren, Belgium.
- Seber, G.A.F. 1982. The estimation of animal abundance. Charles Griffin & Co. Ltd., London, UK, 654 pp.
- Sorgeloos, P. 1987. Brine shrimp *Artemia* in coastal saltworks: hydrobiological key to improved salt production and inexpensive source of food for vertically integrated aquaculture. 133-141. Proc. International Meeting on "Saltworks Conversion for Aquaculture", Trapani, Italy, May 9-11, 1986.
- Tackaert, W. and Sorgeloos, P. 1991a. Semi-intensive culturing in fertilized ponds: 287-315. In: *Artemia Biology*. Browne, R.A., Sorgeloos, P. and C.N.A. Trotman (Eds), CRC Press, Inc., Boca Raton, Florida, USA, 374 p.
- Tackaert, W. and Sorgeloos, P. 1991b. Biological management to improve *Artemia* and salt production at Tang Gu saltworks in the People's Republic of China. 78-83. In : Proceedings of the International Symposium "Biotechnology of solar saltfields", Tang Gu, PR China, September 17-21, 1990, Cheng, L. (Ed.), Salt Research Institute, Tanggu, Tianjin, PR China, 283 pp
- Tackaert, W., and Sorgeloos, P. 1993. The use of brine shrimp *Artemia* in biological management of solar saltworks: 671-622. In: Proc. 7th Intl Symposium on Salt, Kakihana, H., Hardy, H.R.jr., Hoshi, T., Tokyokura, K. (Eds). Vol. 1, Elsevier Science Publishers B.V., Amsterdam, The Netherlands.

- Triantaphyllidis, G.V., Pouloupoulou, K., Abatzopoulos, T.J., Pinto Perez, C.A. and Sorgeloos, P. 1995. International study on *Artemia*. XLIX. Salinity effects on survival, maturity, growth, biometrics, reproductive and lifespan characteristics of a bisexual and a parthenogenetic population of *Artemia*. *Hydrobiologia*, 302:215-227
- Vanhaecke, P. and Sorgeloos, P. 1982. International Study on *Artemia*. XVIII. The hatching rate of *Artemia* cysts - a comparative study. *Aquacultural Eng.* 1(4): 263-273.
- Vu Do Quynh and Nguyen Ngoc Lam. 1987. Inoculation of *Artemia* in experimental ponds in Central Vietnam : an ecological approach and a comparison of three geographical strains. 253-269. In: *Artemia* Research and its Applications. Vol. 3. Sorgeloos, P., Bengtson, D.A., Declair, W. and Jaspers, E. (Eds). Universa Press, Wetteren, Belgium.

4.5.9. Worksheets

WORKSHEET 4.5.1. POND IMPROVEMENTS AND HARVESTING PROCEDURES

A/ POND IMPROVEMENTS:

- to prevent cysts being washed ashore:
 - steepen banks on the down wind side of prevailing winds
 - install cyst barriers close to the shore line (Figure 4.5.22)
 - dig a short canal (1 to 2m wide, 3 to 6m long) on the down wind side of the pond to act as a cyst collection trap.
 - install wave breakers to prevent excessive foam formation and loss of cysts through airborne foam e.g.:
 - bamboo poles close to the shore (Figure 4.5.23).
 - make a row of palm leaves (stuck into bottom of the pond) close to the shoreline (Figure 4.5.24)
-

B/ HARVESTING PROCEDURES:

- harvest floating cysts with double screen dip-nets (Figure 4.5.25 and 4.5.26) in order to separate cyst from floating debris and adult *Artemia*
 - if pond modifications are not possible (e.g. large solar salt operations), harvest cysts from the shore on a daily basis and rinse the cysts with pond brine using double screen dip-nets
 - if the previous history of the cysts is not known, perform the following on the spot evaluations to check the cyst quality:
 - a/ determine percentage of heavy debris (e.g. sand, for cysts harvested on the shore):

Add approximately 100 g of cyst material in a 250 ml graduated conical shaped container filled with brine. Mix thoroughly and leave to settle for 10 min. Cysts will float and heavy particles will sink. The volume percentage gives a first indication of the amount of heavy debris in the cyst material. Moreover, if the heavy debris sink fast and are densely packed on the bottom, this indicates a high weight percentage of debris.
-

- b/ determine the percentage of cracked cysts or empty shells:
- check quantity of cracked shells with field microscope
 - check the swelling capacity of the cysts by hydration of 2 ml cysts in tap water in a (graduated) tube, within 1 to 2 h the volume of the (now hydrated) cysts should have doubled
 - check the amount of full cysts by removal (dissolution) of the cysts shells; *i.e.* a small sample of cysts is suspended in hypochlorine solution (domestic bleach water); within 5 min the shells have dissolved and the (white to orange colored) embryos can be distinguished with the naked eye.
- c/ check for early hatching:
- hydrate a small amount of cysts (100 to 200 cysts) for 2 to 3 h in fresh water and check for early hatchers. If many cysts are hatching (check for free swimming nauplii or umbrella stage with field microscope), the hatching metabolism has reached a late stage and subsequent processing will reduce the hatchability of the cyst product.
 - store cysts from different harvesting sites and/or harvesting periods separately since diapause deactivation techniques and final hatching quality may vary according to:
 - pond conditions during production *e.g.* salinity, food availability
 - the harvesting period *e.g.* beginning, middle, end of production season (probably due to different climatic conditions)
 - the harvesting period *e.g.* short time or long time after inoculation (probably due to differences between different brood cycles) .

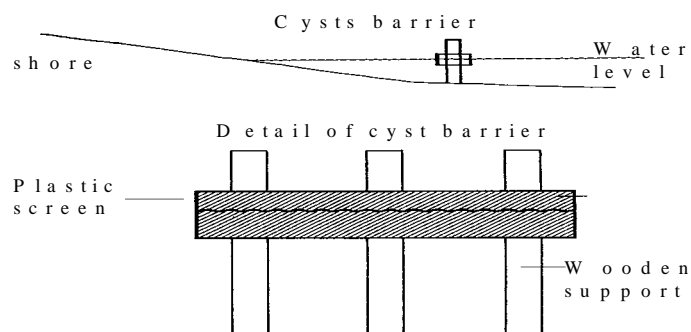

Figure 4.5.22. Installation of cyst barriers to keep cysts in the water.



Figure 4.5.23. Floating bamboo poles used as wave-brakers for the harvesting of *Artemia* cysts.



Figure 4.5.24. Row of palm leaves close to the shoreline.

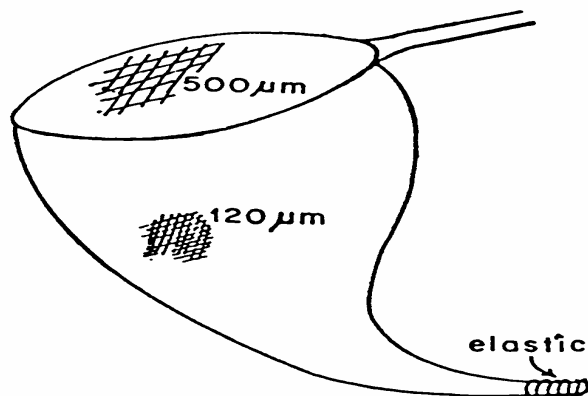

Figure 4.5.25. Double-screen dip net.

WORKSHEET 4.5.2. PROCEDURES FOR THE BRINE PROCESSING STEP

A/ BRINE DEHYDRATION

- Brine dehydration in controlled environment (e.g. brine tanks or specially prepared brine ponds):
 - submerge cysts in saturated brine for 48 h
 - for a high ratio of cysts to brine (e.g. 20 to 50% cysts to brine ratio on a volume/volume basis when using small brine tanks), exchange brine 2 to 3 times over 48 h to compensate for dilution due to release of water from the cysts.
 - for a low ratio of cysts to brine (e.g. use of brine ponds or large tanks), exchange of brine is not necessary
 - always mix cysts and brine regularly to ensure homogeneous dehydration
 - collect material and proceed with next processing step or store temporarily using procedures described in section 4.5.7.2.
- Brine dehydration in less-controlled environment (e.g. use of crystallize ponds):
 - collect or transfer cysts in non-waterproof bags (e.g. strong cotton or jute)
 - submerge bags in brine
 - allow for longer dehydration time (3 to 4 days) as diluted brine (due to extracted cyst water) is slowly replaced by surrounding saturated brine.
 - collect material and proceed with next processing step or store temporarily using procedures described in section 4.5.7.2.

B/ SIZE SEPARATION IN BRINE

- For small batches (up to 5 kg):
 - use double screen dip-nets (Figure 4.5.25) and pond brine as described in harvesting procedures.
 - collect the cysts and proceed with the next processing step or apply temporary storage as described in section 4.5.7.2.
- For large batches and or cyst material containing a lot of organic matter:
 - use (vibrating) sieves (e.g. 1 mm, 0.5 mm, 0.15 mm) at a centralized processing site
 - transfer cysts on sieves and rinse thoroughly with brine
 - if separation takes place prior to dehydration, use pond brine or saturated brine (the latter initiates the dehydration process)
 - if dehydration was performed prior to size separation, use saturated brine to avoid rehydration
 - collect material in 0.15 to 0.5 mm size range and proceed with next processing step or store temporarily using procedures described in section 4.5.7.2.

C/ DENSITY SEPARATION IN BRINE

- use of special brine separation tanks:
 - use a (transparent) conical shaped tank fitted with a bottom valve (Figure 4.5.27); for large tanks (> 500 l) a pump should be fitted to the discharge
 - fill tank with saturated brine (better floatation of cysts + initiates dehydration process)
 - add cyst material : 10 to 20 kg cysts for 100 l brine
 - mix thoroughly (e.g. strong aeration) for 5 to 10 min. and allow heavy debris to settle and cysts to float for 5 to 10 minutes
 - discharge heavy debris through bottom valve (add brine at valve inlet to initiate flow of packed debris)
 - repeat above procedure if required (e.g. in presence of organic matter which sinks slowly)

- finally mix thoroughly (e.g. strong aeration) and collect the floating fraction through the bottom valve
- use of large brine tanks or specially constructed brine pond:
 - use tank/pond which is more than 1 m deep (to permit accumulation of heavy debris)
 - fill tank/pond with saturated brine
 - bring cysts into tank/pond
 - mix (not too strong mixing as to avoid suspension of bottom debris)
 - allow heavy debris to settle and cysts to float
 - repeat several times
 - if convenient leave cysts in tank/pond for 48 hours to allow dehydration
 - remove cysts from tank/pond using scoop nets or pumps
 - collect cysts (e.g. in bags if removed by hand, over sieves if pumped) and proceed with following processing step
 - after some time heavy debris must be removed from tank/pond



Figure 4.5.26. Harvesting cysts from seasonal salt ponds integrated for *Artemia* production.



Figure 4.5.27. A vertical spin dryer (for removal of excess water) and a transparent conical shaped tank with a bottom valve (for density separation).

WORKSHEET 4.5.3. PROCEDURES FOR THE FRESHWATER PROCESSING STEP

A/ REMOVAL OF EXCESS BRINE

- transfer brine-submerged cysts to bags (e.g. cotton, jute) and allow brine to leak out for 24 h.
- for a wet-dry product (already in bags) make sure no salt crystals are mixed with the cysts
- alternatively rinse cysts as described in section D prior to separation

B/ DENSITY SEPARATION IN FRESH WATER (20 minutes)

- use a (transparent) conical shaped tank fitted with a bottom valve (Figure 4.5.27); for large tanks (> 500 l) a pump should be fitted on the discharge (same tanks as for density separation in brine)
- fill tank with freshwater
- for disinfection apply procedure described in section C
- add cysts at a rate of approximately 10 to 15 kg wet-dry cysts in 100 l water
- mix thoroughly (e.g. apply strong aeration) for 5 to 10 min
- allow sedimentation for 10 min
- collect high density sinking fraction through bottom valve (by gravity or through pumping)
- add freshwater to valve inlet to improve material flow
- when sinking fraction is collected, apply aeration and collect floating fraction separately
- for small quantities (up to 15 kg) collect in 150 µm bags
- for large quantities collect over (vibrating) sieves (5 to 10 minutes)
- proceed with E/ for sinking fraction
- if floating fraction contains a significant quantity of full cysts, dehydrate floating fraction in saturated brine and re-process at a later date (second grade product)

C/ DISINFECTING

- add hypochlorite (liquid bleach) to freshwater prior to adding the cysts and mix thoroughly.
- concentration of active chlorine in freshwater must be around 200pm

D/ RINSING (5 to 10 min)

- for small quantities (up to 20 kg) use a concentrator-rinser type system (see Figure 4.3.2.) or a 150 micron bag fitted in a slotted container (Figure 4.5.28)
- for large batches, rinse over (vibrating) sieves with ample spraying of freshwater

E/ REMOVAL OF EXCESS WATER (5 to 10 minutes)

- subsequent to separation/rinsing, collect cysts in cloth bags and squeeze firmly
 - place bags in centrifuge for further removal of excess water:
 - use a vertical spin dryer for small batches (up to 5 kg) see Figure 4.5.27
 - use industrial centrifuge for larger batches
 - do not use centrifuge with very high gravity forces as this will destroy the cysts
 - do not centrifuge for too long as cysts will clog together in big clumps which are difficult to dry
 - proceed with brine dehydration or drying
-



Figure 4.5.28. A 150 μm bag filter fitted in a slotted container for rinsing of cysts.

5. ZOOPLANKTON

Daan Delbare, Philippe Dhert and Patrick Lavens

Laboratory of Aquaculture & Artemia Reference Center
University of Gent, Belgium

5.1. Wild zooplankton

5.1.1. Introduction

Zooplankton is made up of small water invertebrates feeding on phytoplankton. Even though "plankton" means passively floating or drifting, some representatives of zooplankton may be strong swimmers. The yearly plankton cycle consists of various phytoplankton species blooming in response to a particular sequence of changes in temperature, salinity, photoperiod and light intensity, nutrient availability, and a consequent bloom of zooplankton populations. Phytoplankton and zooplankton populations are therefore intimately linked in a continuous cycle of bloom and decline that has evolved and persisted throughout millions of years of evolution.

Studies on the stomach contents of fish larvae caught in their natural environment clearly show that almost no fish species can be regarded as strongly stenophagic (specialized in feeding on only a few or just one zooplankton species), though some specialization may occur (i.e. due to size limitations for ingestion).

There are three obvious advantages of using wild zooplankton as a live food source for the cultivation of the early larval stages of shrimp or fish species:

- As it is the natural food source, it may be expected that its nutritional composition maximally covers the nutritional requirements of the predator larvae, especially with respect to essential fatty acids and free amino acids (Tables 5.1, 5.2 and 5.3).
- The diversified composition of wild zooplankton in terms of species variety as well as ontogenetic stages assures that optimal sizes of prey organisms will be available and efficient uptake by the predator is possible at any time during the larval rearing.
- Depending on the harvesting potential nearby the hatchery facility, there might be a low cost involved in the harvest of this live food compared to the infrastructure and production costs of the live food items discussed earlier.

On the other hand, there are also major drawbacks in the use of zooplankton, including: (1) irregular supply due to dependence on natural (in lakes or oceans) or induced (in ponds) phytoplankton blooms; and (2) the introduction of diseases and parasites in the fish culture tanks through infested wild zooplankton, (e.g., fishflea *Argulus foliaceus* and *Livoneca* sp. etc.), parasitic copepods (*Lernaea* sp. and *Lernaeascus* sp., etc.).

Table 5.1. Biochemical composition of wild zooplankton collected at Maizura Bay, Japan (modified from Kuroshima *et al.*, 1987).

	October	May	June	July	August
Moisture (%)	-	89.7	87.0	91.1	91.2
Crude protein (%)*	63.2	74.2	68.7	65.5	66.8
Crude lipid (%)*	9.4	9.8	12.1	12.6	17.2
Crude ash (%)*	11.1	8.8	9.5	9.9	9.2
16:0	23.8	25.5	24.2	21.3	20.1
16:1n-7	8.8	10.8	11.4	8.2	8.6
18:0	8.9	5.6	6.2	9.4	6.7
18:1n-9	13.7	12.9	8.5	7.1	7.4
18:2n-6	2.2	5.0	3.6	5.1	3.9
18:3n-3	5.7	1.8	1.3	7.9	9.3
18:4n-3	4.2	2.0	3.4	6.3	8.7
20:1	2.1	0.6	1.0	2.0	2.2
20:4n-3	0.8	0.1	0.4	1.1	0.5
20:5n-3	8.6	9.5	8.4	8.7	8.6
22:5n-3	1.0	Tr.	0.6	0.3	0.8
22:6n-3	10.6	14.1	11.8	10.0	7.0
*dry weight basis					

Table 5.2. Free fatty acid composition (FFA; area% of total lipid) of wild zooplankton compared to freshly-hatched *Artemia* nauplii (AF grade) (modified from Naess and Bergh, 1994).

	Wild zooplankton	<i>Artemia</i>
14:0	3.4	0.8
16:0	16.9	12.6
16:1n-9	0.7	0.9
16:1n-7	1.7	4.0
16:2n-4	0.3	0.2
18:0	3.7	7.4
18:1n-9	2.9	22.5
18:1n-7	3.3	10.6
18:2n-6	2.0	6.8
18:3n-3	1.5	20.3
18:4n-3	1.5	2.3
20:1n-9	0.2	0.7
20:1n-7	0.6	0.1
20:4n-6	0.8	2.3
20:4n-3	0.5	0.6
20:5n-3	21.1	3.6
22:0	0.5	1.1
22:1n-11	0.0	Tr.
22:5n-3	0.8	0.1
22:6n-3	32.9	0.2
Sum (n-3)PUFA	58.3	27.1
Sum (n-6)PUFA	2.8	9.1
n-6/n-3 PUFA	0.0	0.3
22:6n-3/20:5n-3	1.6	0.1
Total lipid ($\mu\text{g}\cdot\text{mg}^{-1}$ WW)	13.0	13.0

Table 5.3. Free amino acid (FAA; $\mu\text{mol.g}^{-1}$ DW) composition of wild zooplankton compared to freshly-hatched *Artemia* nauplii (AF grade) (modified from Naess and Bergh, 1994).

	Wild zooplankton	<i>Artemia</i>
FAA		
Aspartic	2.1	1.2
Glutamic	2.0	3.6
Asparagine	1.5	1.3
Serine	3.8	2.3
Histidine	1.3	0.7
Glutamine	2.8	2.8
Glycine	23.0	2.0
Threonine	2.1	1.3
Arginine	9.9	3.6
Alanine	9.1	4.4
Taurine	32.7	7.6
Tyrosine	1.5	1.1
Valine	3.8	2.1
Methionine	4.7	2.2
Tryptophan	0.6	0.3
Phenylalanine	2.1	1.5
Isoleucine	2.4	1.5
Leucine	4.5	2.5
Lysine	6.6	3.9
Total FAA	116.6	45.9

5.1.2. Collection from the wild

Zooplankton can be collected from seawater bodies as well as freshwater lakes or ponds. For aquaculture purposes, approximately 80% is of marine origin. Around 25 species of copepods, mysids and euphausiids are commercially harvested. Leading countries in using wild zooplankton in industrial aquaculture are Norway (annual catch ranges between 20 to 50 tonnes), Canada and Japan. The global annual catch of planktonic crustaceans (essentially krill) is around 210,000 tonnes, but only a small percentage is used as a direct food source in aquaculture (live or deep frozen).

On the Mediterranean and Atlantic coasts of France, densities of copepods (which make up 85% of the zooplankton) may range from 500 copepods per m^3 in winter (November-February) to more than 10,000 per m^3 in spring and summer. On average 1,000 copepods per m^3 are found in the littoral zone; this figure may, however, be higher in lagoons and estuaries. In some eutrophic brackish water fjords in Norway, for instance, abundant numbers of the copepod *Eurytemora* may be found, including 6 to $30 \cdot 10^6$ adults, 15 to $25 \cdot 10^6$ copepodites, and 25 to $50 \cdot 10^6$ nauplii per 100 m^3 of water. This is roughly equivalent to 100 to 300 g ($1\text{-}3 \text{ mg.l}^{-1}$) biomass dry weight for the different ontogenetic stages of this copepod.

Although these production figures are high, the required quantities for commercial hatcheries may be enormous. It is calculated that approximately 3000 live prey are needed to produce one European seabass larva. During rearing it is thus necessary to filter 3 m^3 water per larval fish or $3 \cdot 10^6 \text{ m}^3 \cdot \text{month}^{-1}$ to supply a hatchery with a production capacity of one million fry. This corresponds to an hourly filtering capacity of 4166 m^3 for a land-based pumping system. When zooplankton is harvested from a boat, a three minute tow with a 1 m diameter plankton net travelling at a speed of 2.6 km.h^{-1} would catch about 100 to 300 g dry weight of zooplankton biomass, assuming a 100% filtration rate of the net. If these copepods were fed to 7-day old carp fry weighing 1 mg dry weight and probably eating 100% of their body weight per day it would be sufficient to supply 1 to $3 \cdot 10^5$ larvae per day on such a short tow.

5.1.3. Collection techniques

Harvesting techniques depend strongly on the location of the harvesting site and should meet the following criteria:

- capable to operate on a continuous basis without surveillance;
- easy to transport and to set up;
- relatively cheap in purchase and maintenance;
- available on site;
- designed for the required quantities and zooplankton sizes.

5.1.3.1. Plankton nets

The following mesh sizes may be used to collect the various sizes of freshwater zooplankton:

- 80 μm for small species of rotifers and larger infusorians. These are an excellent starter feed especially for the fry of some fishes that need small food in the early stages (tench, grass carp, silver carp, big head, carp);
- 160 μm for larger rotifers, nauplius and copepodite stages of copepods;
- 300 and 500 μm for small water fleas and smaller species of cyclopoid copepods;
- 700 μm for adult water fleas of the *Daphnia* genus, large species of cyclopoid and calanoid copepods, larvae and pupae of *Corethra sp.*, etc.

A multi-purpose plankton net for zooplankton collection is schematically shown in Fig. 5.1. The net is conical shaped, 3-3.5 m long, the inlet opening is 1-1.2 m in diameter and the end hole has a diameter of 0.2-0.5 m. There is a strip of thicker cloth on both ends; the front end is furnished with buoys to allow the net to be fixed to a frame. The rear end may consist of a PVC cylinder (2 l), which can be closed on one side.

Nets for hand collection of zooplankton are of the sac type, 50-60 cm long. The net is fixed to a metallic ring, 40-50 cm in diameter, held on a rod of about 2 m long. Collecting zooplankton with hand nets is rather unefficient: one person can catch about 0.1 to 1.0 kg of plankton per hour, depending on the amount of zooplankton biomass in the reservoir.

These dimensions of the nets are given just for orientation and can of course be adjusted as needed. However, one should be aware that the greater the surface area of the net the more effective and rapid the filtration. Hence, the upper limit of the dimensions of the nets depends on the ease of handling rather than anything else. The effectiveness of filtering is also

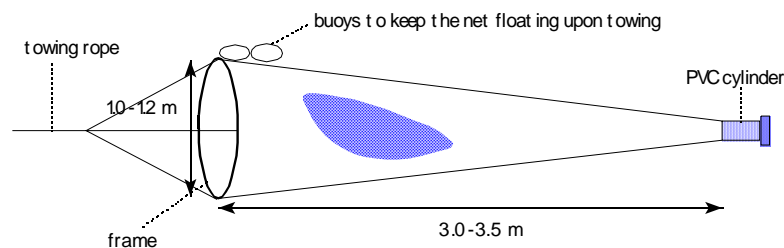

Figure 5.1. Conical harvesting net for plankton collection from ponds or lakes

influenced by the mesh size of the net: the denser the net the faster it will clog, hence, the smaller its effectiveness. It is therefore necessary to estimate with great accuracy the required size of the food particles with respect to the age and species of the fry and to use an optimal mesh size.

5.1.3.2. Trawl nets

A fishing boat equipped with a frame on which 2-4 plankton nets can be installed on both sides of the boat can be used for this purpose (Fig. 5.2.). Good results have been obtained with a rectangular frame of 1 x 0.6 m and a mesh of 160 μm . When this net is moved at a speed of 1.5 $\text{km}\cdot\text{h}^{-1}$ average yields of 40 kg live zooplankton can be harvested in 1 h. In order to minimize the damage to the concentrated plankton, the nets must be emptied every 15-30 min.

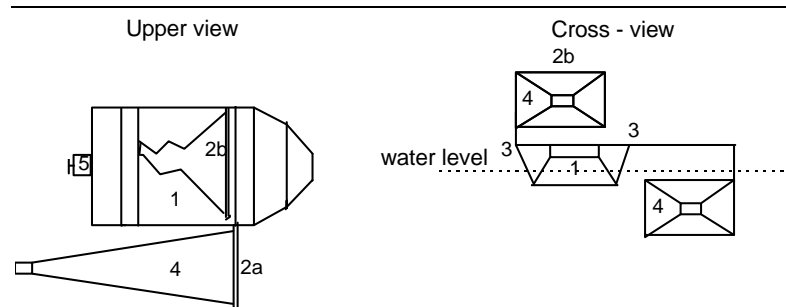

Figure 5.2. Boat with plankton nets dragged along. 1) boat; 2) frame with plankton net, a. in working position, b. net lifted; 3) hinge; 4) plankton net; 5) motor (modified from Machacek, 1991).

5.1.3.3. Baleen harvesting system

The Baleen harvesting system consists of a boat specifically designed for harvesting zooplankton (Fig. 5.3.). This vessel can filter the surface water at rates up to 400 $\text{l}\cdot\text{s}^{-1}$. The zooplankton is scooped onto a primary dewatering screen, after which the organisms are graded through a series of sieves. The stainless-steel mesh of the sieves and primary screen can be changed according to the requirements of the target species. The graded and concentrated zooplankton is stored in wells in the floaters of the vessel and can be unloaded by pumping. The boat can be operated by one person and is powered by an outboard motor and auxiliary petrol engine to drive the pumps and hydraulic rams.

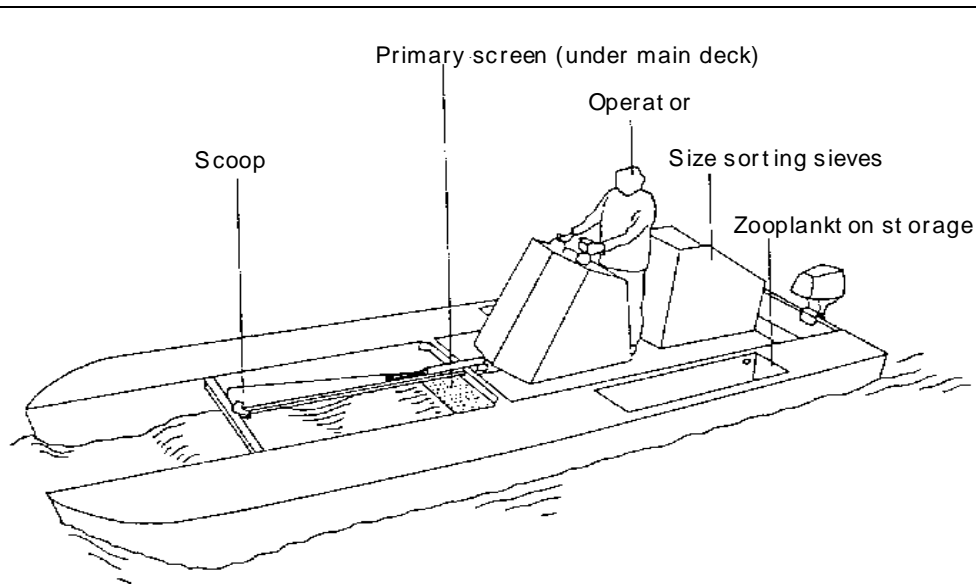

Figure 5.3. The Baleen zooplankton harvesting system (Frish Pty. Ltd., Australia).

5.1.3.4. Flow-through harvesting

- Lake outflows

In reservoirs with a high water flow, a plankton net of adequate size may be placed at the outlet or overflow; in this way the zooplankton present in the water leaving the reservoir can be concentrated. In the case of ponds, the frame of the plankton net may be fixed to the pond gates. The amount of zooplankton collected depends on the zooplankton concentration in the water flowing out of the reservoir and on the volume of the water leaving the reservoir. Again, the nets should be emptied once or twice an hour, depending on prevailing conditions.

This method can be used effectively only in the case where the flow rate of the water at the outlet of the pond is at least 5 to 10 l.s^{-1} . Optimum conditions for this method exist in large eutrophic lakes where the flow rate at the outlet is $> 1 \text{ m}^3.\text{s}^{-1}$ and where several hundred kilos of zooplankton biomass are discharged every day.

- Propeller-induced water flows

Instead of using a motorboat, a propeller can also be actioned from an anchored pontoon, platform, bridge close to the shore, or on a free-floating boat. In all cases, the plankton net needs to be held at a safe distance from the propeller driven by the motor (Fig. 5.4.).

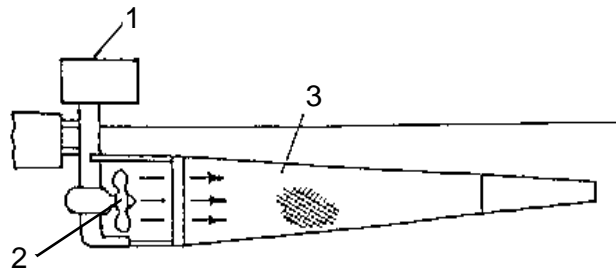

Figure 5.4. Equipment to collect zooplankton with a boat motor (1) with propeller (2), and a plankton net (3) (Modified from Machacek, 1991).

If the distance from the propeller to the net is short, the inlet opening of the net can be reduced and the length of the net increased in order to ensure adequate filtration and prevent losses due to the narrow and strong back current. The longer the distance between the propeller and the net, the wider and shorter the net can be. The distance between the propeller and the net generally ranges from 0.3 to 1.5 m. When equipments of this type are used in shallow reservoirs (below 1 m), care should be taken not to disturb the sediments from the bottom which would clog the net. Therefore, the propeller should be installed close to the water surface. A propeller rotating at 5600 rpm placed at a distance of 1 m of a small plankton net (inlet 30 x 30 cm, mesh size 200 μm), may collect up to 10 kg of zooplankton per hour.

The damage caused by the propeller to the zooplankton is relatively low, but considerable losses may be caused by combustion engines whose exhausts are blown under the water surface.

For rotifers special collecting equipment has been constructed to avoid the rapid clogging of the filter bag due to the accumulation of the small-sized zooplankton (< 100 μm). The collecting apparatus is provided with an automatic cleaning equipment of the filter bag. A propeller is obliquely mounted upstream of a partly submerged cylindrical sieve, that rotates at 15 rpm. Water passes through the cylinder and plankton accumulates on the filter wall.

When part of the filter with attached plankton comes out of the water, the plankton is rinsed from the filter wall by water jets, and collected into a central gutter (Fig. 5.5.).

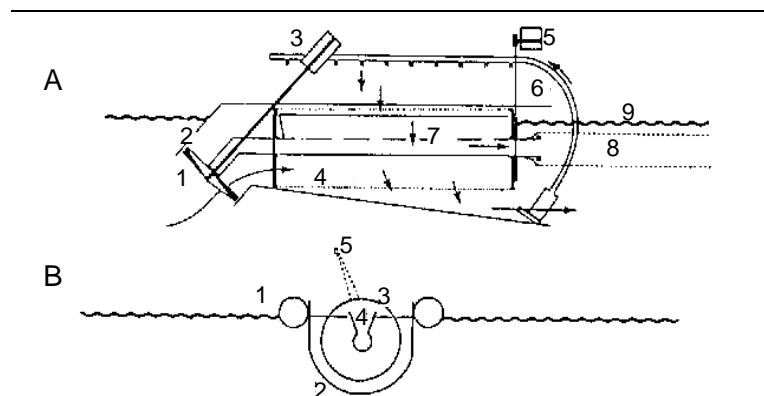

Figure 5.5. Collecting apparatus for rotifers. A. Profile of the self-cleaning plankton harvester. 1) Propeller; 2) Inlet tube; 3) Electro motor (12 V, 24 W and 100 rpm); this motor can also operate the rotating sieve; 4) Intermediate conical gear system; 5) Electro motor to drive the rotating sieve (12 V, 24 W and 20 rpm); 6) Submerged pump for the spray washing system (15 V and 60 W) with feed pipe to jets; 7) Recovery trough for washing water and plankton; 8) Filter sack for storage of concentrated plankton; 9) Water level; Floaters are not shown. B. Cross-section of the apparatus. 1) Lateral floats; 2) Casing around the apparatus; 3) Microsieve; 4) Recovery trough; 5) Spray bar offset from centre (Barnabé, 1990).

With these devices it is necessary to replace the batteries and to harvest the plankton once or twice a day to reduce mechanical damage of the plankton. The transport of the zooplankton can be carried out in water in a 50 l reservoir and must be carried out very quickly, since the viability of the harvested plankton is low (1h after harvesting already 5% mortality is observed).

- Pump-induced water flows

Another method of collecting zooplankton is to use pumps to pump the water into a plankton net. The plankton net may be located at some distance from the outlet of the pump or may be tightened with a string or rubber band straight to the outlet pipe of the pump. The latter method is better because no plankton can escape by back flushing from the net, but needs more frequent emptying of the net as denser nets are prone to clogging. Using an electric pump with a capacity of $5 \text{ l}\cdot\text{s}^{-1}$, as much as 0.5 to 5 kg of zooplankton (depending on zooplankton biomass in the reservoir) may be collected in a net with a mesh size of $160 \mu\text{m}$ in 1 h (Fig. 5.6.).

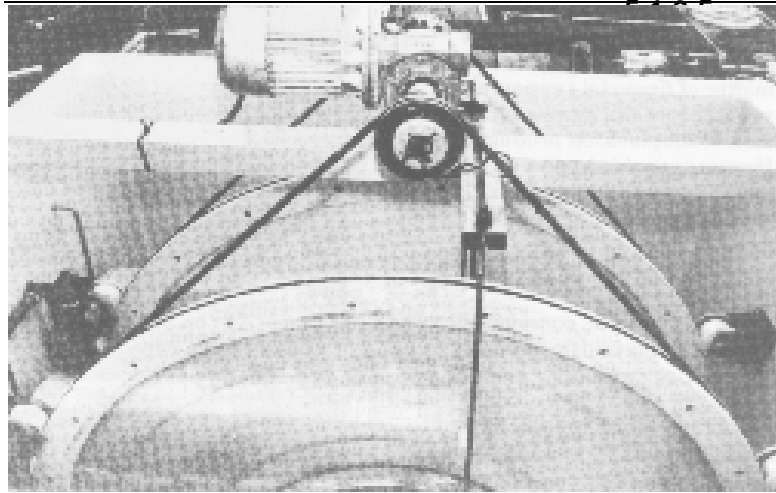

Figure 5.6. Zooplankton is removed from the lagoon by a wheel filter. The plankton is retained on the belt-driven, rotating wheels of the plankton mesh. These wheels are continuously cleaned from behind by a flushing arm. The harvested plankton is collected in a box.

5.1.3.5. Plankton light trapping

A more elegant method for zooplankton collection takes advantage of the positive phototactic behaviour of some zooplankton species. The effectiveness of light to attract the zooplankters is directly dependent on the water transparency and on the intensity of the light source. It is useless to apply this method where the water transparency is below 30 cm. Cladoceran and cyclopoid copepods respond most sensitively to light, rotifers less. The best results of collecting zooplankton with light are obtained in the early night (until about 10 pm); later the effectiveness declines. Though the success of this method may vary, the low expenditure necessary for its application seems to make it an economically viable harvesting system for freshwater species (Nellen, 1986).

5.1.4. Zooplankton grading

Grading can be accomplished by a set of superimposed sieves with varying mesh sizes. These filters should be submerged so as to minimize mortality. A special device for continuous and automated harvesting and grading has been described by Barnabé (1990) and is schematically outlined in Fig. 5.7. It consists of rotating cylindrical sieves with decreasing mesh size from upstream to downstream.

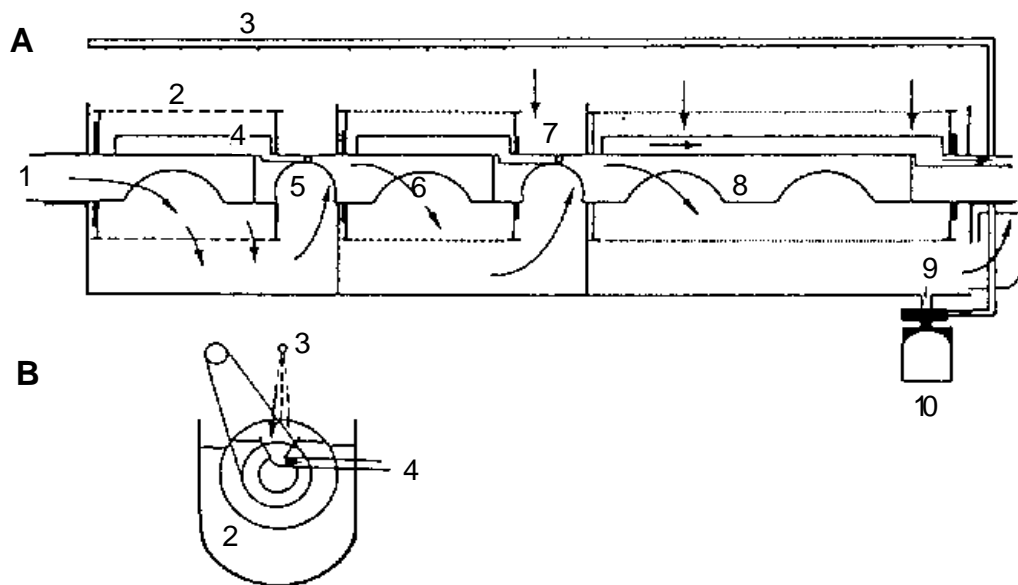

Figure 5.7. Plankton grader. A. longitudinal section. 1) Inflowing water with high concentration of plankton; 2) First filter drum (500 μm); 3) Spray washing systems with jets; 4) Channel for collecting plankton; 5) Filtered water directed to second filter drum (250 μm); 7) Lateral channel for evaluation of cleaning water and plankton; 8) Third filter drum (71 μm); 9) Outflow of filtered water; 10) Pump for rinsing water. B. Cross-section. The system for driving the drums (not shown in A) is shown here as is the water level and the outflow points for rinsing water (Barnabé, 1990).

5.1.5. Transport and storage of collected zooplankton

Harvest and transport of zooplankton interferes considerably with the survival of these fragile organisms. If it is impossible to convey the material continuously along distribution pipes to the place of consumption, the normal practise is to concentrate and transport the harvested zooplankton in 50 l containers. Under these conditions the survival of the zooplankton depends on the amount of oxygen dissolved in the remaining water. At a concentration of 100 g.l⁻¹, zooplankton can be kept at 10°C without oxygenation for only 15-20 min. At higher temperatures or if the zooplankton is to be kept alive for longer periods, the concentration must be reduced substantially. At a temperature of 18-20°C it can be kept at a concentration of 15-20 g.l⁻¹ without aeration for as long as about 4 - 5 h, although the most sensitive organisms will die. This is certainly the case for *Bosmina*, *Daphnia* and others, that are very sensitive to oxygen depletion. Rotifers, cyclopoid copepods and their developmental stages are less sensitive, and some species of the genus *Moina*, larvae of the genus *Corethra*, and *Daphnia magna* are very resistant to low oxygen levels.

When the collected zooplankton is transferred from the net to the transport container, part of the material stays in a layer just above the bottom. These organisms are either mechanically damaged or immobilised and could be administered to the fry first. However, when these organisms die, they will soon start to decay. It is useless to administer these dead animals because the fish will refuse it and their decomposing bodies will spoil the water quality of the rearing system. For this reason, dead zooplankton should always be separated from live zooplankton by decantation.

Preservation of harvested material for long periods is difficult. At present, freezing is the only method used on a large scale. But even at very low freezing temperatures, (i.e. -198°C) one-third of the free and protein-bound amino acids are lost from the plankton samples through sustained proteases activity and leaching. Dehydration has been used successfully on a small scale, while salting causes mortality in fish. Ensilage, using various acids has also been attempted, but needs further investigations.

5.2. Production of copepods

5.2.1. Introduction

Numerous studies have demonstrated that copepods may have a higher nutritional value than *Artemia*, as the nutritional profile of copepods appear to match better the nutritional requirements of marine fish larvae. Furthermore, they can be administered under different forms, either as nauplii or copepodites at startfeeding and as ongrown copepods until weaning. Moreover, their typical zigzag movement, followed by a short gliding phase, is an important visual stimulus for many fish which prefer them over rotifers. Another advantage of the use of copepods, especially benthos-type species like *Tisbe*, is that the non-predated copepods keep the walls of the fish larval rearing tanks clean by grazing on the algae and debris.

Several candidate species belonging to both the calanoid and the harpacticoid groups have been studied for mass production. Calanoids can be easily recognized by their very long first antennae (16-26 segments), while the harpacticoids have only a short first antennae (fewer than 10 segments).

- calanoids:
 - *Acartia tonsa*
 - *Eurytemora affinis*
 - *Calanus finmarchicus* & *C. helgolandicus*
 - *Pseudocalanus elongatus*
- harpacticoids :
 - *Tisbe holothuriae*
 - *Tigriopus japonicus*
 - *Tisbenta elongata*
 - *Schizopera elatensis*

Although some success has been reported when using cultured copepods as live food in fish larviculture, it should be pointed out that the economic feasibility (or not) of copepod culture may be the main bottleneck for its routine application. Infrastructure and labour costs for the production of sufficient quantities of live copepods for commercial hatchery operations may indeed be prohibitive.

5.2.2. Life cycle

The Copepoda are the largest class of crustaceans forming an important link between phytoplankton and higher trophic levels in most aquatic ecosystems. Most adult copepods have a length between 1 and 5 mm. The body of most copepods is cylindrical in shape, with a wider anterior part. The trunk consists of two distinct parts, the cephalothorax (the head being fused with the first of the six thoracic segments) and the abdomen, which is narrower than the cephalothorax. The head has a central naupliar eye and uniramous first antennae, that are generally very long.

Planktonic copepods are mainly suspension feeders on phytoplankton and/or bacteria; the food items being collected by the second maxillae. As such, copepods are therefore selective filter-feeders. A water current is generated by the appendages over the stationary second maxillae, which actively captures the food particles.

The male copepods are commonly smaller than the females and appear in lower abundance than the latter. During copulation the male grasps the female with his first antennae, and deposits the spermatophores into seminal receptacle openings, where they are glued by means of a special cement. The eggs are usually enclosed by an ovisac, which serves as a brood chamber and remains attached to the female's first abdominal segment. Calanoids shed their eggs singly into the water. The eggs hatch as nauplii and after five to six naupliar stages (moltings), the larvae become copepodites. After five copepodite moltings the adult stage is reached and molting is ceased. The development may take from less than one week to as long as one year, and the life span of a copepod ranging from six months to one year.

Under unfavourable conditions some copepod species can produce thick-shelled dormant eggs or resting eggs. Such cysts can withstand desiccation and also provide means for dispersal when these are carried to other places by birds or other animals. In more northern regions a diapause stage is present in the development of the copepods so as to survive adverse environmental conditions, such as freezing; such a diapause usually taking place between the copepodite stage II to adult females and recognised by an empty alimentary tract, the presence of numerous orange oil globules in the tissue and an organic, cyst-like covering. The major diapause habitat is the sediment, although a minor part of the diapausing individuals may stay in the planktonic fraction, the so-called "active diapause".

5.2.3. Biometrics

The size of copepods depends on the species as well as on the ontogenetic stage. Various copepod sizes are used for specific larviculture applications, assuring an efficient uptake by the target predator at any time during its larval rearing.

The harpacticoid *Tisbe holothuriae* grows from a nauplius size of 55 μm to an adult size of more than 180 μm , *Schizopera elatensis* from 50 to 500 μm , and *Tisbentra elongata* from 150 to more than 750 μm . Sizes for *Eurytemora* sp. (Calanoidea) are on an average 220 μm , 490 μm , and 790 μm for nauplii, copepodites, and adults, respectively.

5.2.4. Nutritional quality

The nutritional quality of copepods is generally accepted to be very good for marine fish larvae, and believed to be of a higher quality than the commonly used live food *Artemia*. In general copepods have a high protein content (44-52%) and a good amino acid profile, with the exception of methionine and histidine (Table 5.4.).

The fatty acid composition of copepods varies considerably, since it reflects the fatty acid composition of the diet used during the culture. For example, the (n-3)HUFA content of individual adult *Tisbe* fed on *Dunaliella* (low (n-3)HUFA content) or *Rhodomonas* algae (high (n-3)HUFA content) is 39 ng, and 63ng respectively, and corresponds to 0.8% and 1.3% of the dry weight. Within nauplii, the levels are relatively higher; (i.e. around 3.9% and 3.4%, respectively). Specific levels of EPA and DHA are respectively 6% and 17% in adults fed *Dunaliella*, and 18% and 32% in adults fed *Rhodomonas*. In nauplii the levels of EPA, DHA and (n-3)HUFA are high, (i.e. around 3.5%, 9.0% and 15%, respectively). The fatty acid profiles of *Tigriopus japonicus* cultured on baker's yeast or Omega-yeast are shown in Table 5.5. and their respective nutritional value for flatfish larvae is shown in Table 5.6.

Differences in the biochemical composition, and in particular the HUFA content, are not the only advantages of copepods over *Artemia* when offered as food to marine fish larval. For example, copepods (copepodites and adults) are believed to contain higher levels of digestive enzymes which may play an important role during larval nutrition.

As mentioned previously, the early stages of many marine fish larvae do not have a well-developed digestive system and may benefit from the exogenous supply of enzymes from live food organisms. Evidence that copepods may be preferable to *Artemia* in this respect comes from Pederson (1984) who examined digestion in first-feeding herring larvae, and found that copepods passed more quickly through the gut and were better digested than *Artemia*.

Table 5.4 Amino acid composition of *Tigropus brevicornis* cultured on different types of food (g.100g⁻¹ crude protein) (Vilela, pers.comm.).

T. brevicornis cultured on *Platymona sueceica* with different additives:

Amino acid	+ yeast	+ rice bran	+ wheat	+ fish food
Aspartic acid	7.30	6.98	7.08	7.63
Threonine	3.35	3.09	3.53	3.74
Serine	3.37	2.98	3.39	3.59
Glutamic acid	12.05	12.00	11.90	10.62
Proline	5.13	4.49	6.56	4.82
Glycine	4.40	4.24	4.31	4.71
Alanine	5.44	5.45	5.97	5.87
Cystine	0.39	0.84	1.23	1.27
Valine	4.52	4.30	4.21	4.71
Methionine	1.78	1.75	1.64	1.81
Isoleucine	3.35	3.21	3.28	3.48
Leucine	4.79	4.71	6.24	6.73
Tyrosine	3.89	3.99	3.21	3.87
Phenylalanine	2.64	2.67	3.37	3.44
Histidine	1.94	1.75	1.78	1.33
Lysine	4.81	4.65	4.81	4.92
Arginine	6.52	6.34	5.76	6.11
Total	75.67	73.44	78.27	78.65
Protein (%)	51.1	48.6	43.9	46.5

Table 5.5. Fatty acid composition of total lipids, triglycerides (TG), polar lipids (PL) and free fatty acid fractions (FFA) in *T. japonicus* cultured on baker's yeast and an Omega-yeast (modified from Fukusho *et al.*, 1980). (%DW).

FA	Baker's yeast				Omega-yeast			
	Total	TG	FFA	PL	Total	TG	FFA	PL
14:0	0.6	0.8	0.7	0.6	1.2	1.8	1.7	0.5
15:0	1.8	1.7	0.8	0.5	0.8	0.6	0.6	0.4
16:0	7.1	8.2	8.1	13.2	9.1	10.1	9.9	13.2
16:1n-7	13.9	22.3	12.8	3.2	6.5	7.2	6.6	2.3
18:0	2.5	0.8	2.1	6.6	2.6	1.3	2.5	6.8
18:1n-9	23.7	31.6	20.6	15.7	22.1	32.4	21.8	14.2
18:2n-6	2.9	2.9	2.4	2.2	1.5	1.4	1.7	1.2
18:3n-3	4.4	5.3	3.8	1.2	0.9	0.7	0.7	0.5
18:4n-3	1.1	0.8	0.8	2.3	9.1	11.5	5.6	3.7
20:1	1.4	0.8	0.8	2.3	9.1	11.5	5.6	3.7
20:4n-3	2.1	1.6	2.0	0.8	0.7	0.4	0.5	0.3
20:5n-3	6.0	2.9	13.1	8.1	4.7	3.2	7.9	6.4
22:1	0.3	0.7	0.5	0.1	5.4	5.9	3.3	2.2
22:5n-3	1.1	0.8	0.7	1.0	0.9	0.7	0.6	0.4
22:6n-3	13.8	5.2	16.8	33.2	20.9	15.8	26.2	38.8
(n-3) HUFA	23.0	10.5	32.6	43.1	27.2	20.1	35.2	45.9

Table 5.6. Survival and growth rate of juvenile mud dab (*Limanda yokohamae*), fed *Tigriopus japonicus* cultured on baker's yeast or Omega-yeast (yeast cultured on a medium enriched with (n-3)HUFA), from 30-days old larvae (average TL 10.30±0.51 mm) to 53-days old in 1 m³ circular tanks (modified from Fukusho *et al.*, 1980).

	Survival rate	Total length (mm)	Body weight (mg)	Condition factor
Baker's yeast	96.1	23.3	90.9	7.1
	91.4	22.3	87.8	7.8
Omega yeast	97.0	23.7	102.5	7.7
	97.4	23.3	104.0	8.1

5.2.5. Culture techniques

In general, it may be stated that harpacticoid copepods are less sensitive and more tolerant to extreme changes in environmental conditions (i.e. salinity: 15-70 g.l⁻¹; temperature: 17-30°C) than calanoids and thus are easier to rear under intensive conditions. Moreover, harpacticoids have a higher productivity than calanoids and can be fed on a wide variety of food items, such as microalgae, bacteria, detritus and even artificial diets. However, as mentioned previously, care should be taken in this respect as the lipid and (n-3) HUFA composition of the copepods is largely dependent on that of the diet fed.

5.2.5.1. Calanoids

A continuous production system for the calanoid copepod *Acartia tonsa* has been described by Støttrup *et al.* (1986). It consists of three culture units: basis tanks, growth tanks and harvest tanks. The *Acartia tonsa* are isolated from natural plankton samples or reared from resting eggs onwards (see 5.2.6. Surface-disinfection of resting eggs).

The basis tanks (200 l grey PVC tanks: 1500 x 50cm) are run continuously, regardless of production demands, and the eggs produced are used to adjust population stocks. These tanks are very well controlled and kept under optimal hygienic conditions: using filtered (1 µm) seawater (salinity 35 g.l⁻¹) and fed with *Rhodomonas* algae (8.10⁸.days⁻¹) produced under semi-sterile indoor conditions. Temperatures are kept at 16-18°C and a gentle aeration from the bottom is provided. Adult concentrations with a ratio of 1:1 males to females are maintained at less than 100.l⁻¹ by adjusting once a week with stage IV-V copepodites. Approximately 10 l of the culture water is siphoned daily from the bottom of the tanks (containing the eggs), and replaced by new, clean seawater. Eggs are collected from the effluent waters by the use of a 40 µm sieve; production averaging 95,000 eggs.day⁻¹, and corresponding to a fecundity rate of 25 eggs.female⁻¹.day⁻¹. The basis cultures are emptied and cleaned two to three times per year, by collecting the adults on a 180 µm sieve and transferring them to cleaned and disinfected tanks.

Collected eggs are transferred to the growth tanks where maximal densities reach 6000.l⁻¹. The nauplii start to hatch after 24 h with hatching percentages averaging 50% after 48 h incubation. Initially *Isochrysis* is given at a concentration of 1000 cells.ml⁻¹ and after 10 days a mixture of *Isochrysis* and *Rhodomonas* administered at a concentration of 570 and 900 cells.ml⁻¹, respectively. The generation time (period needed to reach 50% fertilised females) is about 20 days with a constant mortality rate of about 5%.day⁻¹.

After 21 days, the adults are collected using a 180 µm sieve and added either to the basis or harvest tanks. Harvesting tanks are only in use once the fish hatchery starts to operate. Cultures are maintained in 450 l black tanks under the same conditions as described above. Each tank receives a daily amount of 16.10⁸ *Rhodomonas* cells, harvested from bloom cultures. These tanks are emptied and cleaned more regularly than stock tanks. To facilitate the harvesting of solely nauplii or copepodites of a specific stage (depending on the requirements), eggs are harvested daily and transferred to the hatching tanks; the aeration levels within these tanks being increased to maintain 80% oxygen saturation. Nauplii of appropriate size (and fed on *Isochrysis*) are harvested on a 45 µm screen and by so doing cannibalism by the copepod adults is also minimized.

The scaling up of the operation to a production of 250,000 nauplii.day⁻¹ usually requires three harvest tanks and a culture period of about two months.

5.2.5.2. Harpacticoids

All species investigated to date have several characteristics in common, including:

- high fecundity and short generation time
- extreme tolerance limits to changes in environmental conditions: *i.e.* salinity ranges of 15-70 mg.g⁻¹ and temperature ranges of 17-30°C.
- a large variety of foods can be administered to the cultures; rice bran or yeast even facilitating a higher production than algae
- potential to achieve high biomass densities: *i.e.* *Tigriopus* fed on rice bran increasing rapidly from 0.05 to 9.5 ind.ml⁻¹ in 12 days

The culture can be started by isolating 10-100 gravid female copepods in 2 to 40 l of pure filtered (1 µm) seawater. The culture is then maintained at a density of at least one copepod per ml at a temperature of 24-26°C. No additional lighting is needed; if outdoor cultures are used, partial shading should be provided. The main culture tanks contain 500 l of filtered seawater (100 µm). Optimal culture densities are 20-70 copepods.ml⁻¹, with a population growth rate of approximately 15%.day⁻¹. Since high densities are used, it is advisable to use (semi) flow-through conditions instead of batch systems so as to avoid deterioration and eutrophication of the culture medium; the main problem here is the clogging of the fine-mesh screen. Food concentrations are maintained at 5.10⁴ to 2.10⁵ cells.ml⁻¹ of *Chaetoceros gracilis* corresponding to a water transparency level of 7-10 cm. Faster growth and higher fecundity can be obtained by using dinoflagellates (*Gymnodinium splendens*) or flagellated green phytoplankton.

The generation time under optimal conditions is about 8-11 days at 24-26°C. *E. acutifrons* having 6 naupliar stages and 6 copepodite stages (including the adult); the newly hatched nauplii (N1) measuring 50 x 50 x 70 µm, and the copepodites C6 measuring 150 x 175 x 700 µm.

Before harvesting the copepods, the biomass and carrying capacity of the population must be calculated. To achieve this three samples of 2 ml should be taken daily and the different development stages counted under a binocular microscope. With these data the required harvest volume can therefore be estimated. N1 can be collected from the culture medium on a 37 µm sieve and separated from the other nauplii using a 70 µm sieve and the copepodites can be concentrated on a 100 µm screen.

With the exception of the culture of *Tigriopus japonicus*, copepod culture should always be free from rotifers. If rotifers should start to take over the culture, then a new stock culture should be started with gravid females as described previously. Check always for rotifers during sampling. In some cases, *T. japonicus* is batch cultured in combination with the rotifer *Brachionus plicatilis* (Fukusho, 1980) using baker's yeast or Omega-yeast as a food source (although the cultures are always started with *Chlorella* algae). A bloom of this alga is first

induced in big outdoor tanks which are subsequently seeded with rotifers and *Tigriopus*, at concentrations of 15-30 animals.l⁻¹. In this way a total amount of 168 kg live weight of *Tigriopus* can be harvested during 89 days at maximal densities of 22,000 animals.l⁻¹; the amount of yeast used for a 1 kg production of *Tigriopus* being 5 to 6 kg.

5.2.6. Use of resting eggs

Many temperate copepods produce resting eggs as a common life-cycle strategy to survive adverse environmental conditions, which is analogous to *Artemia* and *Brachionus* sp. Experiments have shown that resting eggs can tolerate drying at 25°C or freezing down to -25°C and that they are able to resist low temperatures (3-5°C) for as long as 9 to 15 months. These characteristics make the eggs very attractive as inoculum for copepod cultures.

Since copepod resting eggs are generally obtained from sediments, they need to be processed prior to their use. Samples of sediments rich in resting eggs can be stored in a refrigerator at 2-4°C for several months. When needed, the sediment containing the resting eggs is brought in suspension and sieved through 150 µm and 60 µm sieves. The size-fraction containing the resting eggs is then added to tubes containing a 1:1 solution of sucrose and distilled water (saturated solution) and centrifuged at 300 rpm for 5 min and the supernatants then washed through a double sieve of 100 µm and 40 µm. The 40 µm sieve with the resting eggs is then immersed in the disinfectant, (i.e. FAM-30 or Buffodine); surface-disinfection being needed to eliminate contaminating epibiotic micro-organisms. Successful experiments have been undertaken with the surface disinfection of resting eggs of *Acartia clausi* and *Eurytemora affinis* (Table 5.7.). After disinfection, the eggs are then washed with 0.2 µm filtered sterile seawater and transferred to disinfected culture tanks (see above) or stored under dark, dry and cool conditions.

Before starting the surface-disinfection procedure attention must be paid to the physiological type of resting eggs. Some marine calanoids are able to produce two kinds of resting eggs, i.e. subitaneous and diapause eggs. Since subitaneous eggs only have a thin vitelline coat covering the plasma membrane, they are more susceptible to disinfectants than the diapause eggs which are enveloped by a complex four-layer structure.

Table 5.7. Effect of various disinfectant procedures on hatching percentage, survival at day 5, and percentage of eggs on which bacterial growth was found after 6 weeks for *Acartia clausi* and *Eurytemora affinis* (modified from Naess & Bergh, 1994).

		Disinfectant			Control
		Glutardialdehyde	FAM-30	Buffodine	
Concentration		250 mg.1 ⁻¹ (v/v)	1% (v/v)	1% (v/v)	-
Application time		3 min	10 min	10 min	10 min
Hatching percentage (%)					
<i>A. clausi</i>		95.8	95.8	100	100
<i>E. affinis</i>		79.2	37.2	83.3	91.7
Survival at Day 5 (%)					
<i>A. clausi</i>		0	78.3	70.8	79.2
<i>E. affinis</i>		73.7	0	100	86.4
Bacterial growth (%) on culture media MB and TSB					
<i>A. clausi</i>	MB	16.7	16.7	54.2	100
	TSB	4.2	0	33.3	100
<i>E. affinis</i>	MB	8.3	20.8	25.0	100
	TSB	12.5	12.5	12.5	100
Glutardialdehyde from Merck (Germany)					
Fam-30 and Buffodine from Evab Vanodine (Preston, UK)					

5.2.7. Applications in larviculture

Cultured copepods have been successfully used in the larviculture of various flatfish larvae. 30 days-old larvae of the mud dab were fed *T. japonicus* cultured on baker's yeast or Omega-yeast, and showed excellent survival and growth rates (Fukusho *et al.*, 1980). For turbot, Nellen *et al.* (1981) demonstrated that the larvae at startfeeding showed a preference for copepod nauplii over *Brachionus plicatilis*; after 14 days culture their feeding preference shifting towards adult copepods. The survival of the larvae was high (50%), and the fry reached 12 mg DW (17 mm TL) at day 26.

Kuhlmann *et al.* (1981) successfully used 7.5 to 10% harvests of 24 m³ *Eurytemora* cultures for feeding turbot larvae. Population densities after 4-6 weeks of culture approximated to several hundred adults and copepodites, and several thousand nauplii per litre. Despite these good results, these authors were not able to stabilize production at such levels or to develop a reliable method, and therefore had to add rotifers in addition to the copepod supply. Although the culture was not fully controlled, Kuhlmann *et al.* (1981) estimated the capacity of his 24 m³ copepod culture and came to the conclusion that this capacity should be sufficient to feed a batch of 4000 freshly-hatched turbot larvae until metamorphosis.

5.3. Mesocosm systems

5.3.1. Introduction

Mesocosm systems are culture systems for fish larvae with a water volume ranging from 1 to 10,000 m³. In these large enclosures a pelagic ecosystem is developed, consisting of a multispecies, natural food chain of phytoplankton (diatoms, flagellates, *Nannochloris*,...), zooplankton (tintinnid ciliates, *Synchaeta* and *Brachionus* rotifers, copepods,...) and predators (fish larvae). Intensification of mesocosms is determined by the initial load and by the level of exogenous compounds (fertilizer,...). Fish larvae are stocked in the mesocosms when prey densities have reached appropriate levels, or the organisms cultured in a mesocosm system are harvested from time to time and supplied to fish larvae held in separate tanks. Environmental conditions of mesocosm systems are fully related to the local climate. The production output of such mesocosms can be improved by rearing different species during one year cycle. The production season can be started with the rearing of one cohort of cold water species (halibut or cod) from February to May, and followed by three cohorts of species that do better in warmer water (turbot, seabream, seabass).

5.3.2. Types of mesocosms

There are two methods to obtain a mesocosm system which offers natural live food during the rearing of the fish larvae, provided that the fish larvae are the sole top predators in the system. In the first method the water in the system is continuously renewed at a high rate. An example of such a system is an isolated tidal pond in which the inflowing water is filtered from predators allowing phyto- and zooplankton to flow into the system, while the outflowing water is filtered to retain the fish larvae in the enclosure. Such a system is called "advective" since it depends on external, rather than internal processes. The other method consists of a semi-enclosed or closed system, which is dominated by internal processes. These systems require less technical backing and are thus more convenient for aquacultural applications.

(Semi-) closed mesocosm systems are small enclosures, which consist of water masses retained:

- by dams in isolated bays, branches of a fjord or lagoons: pold system
- in bags hung up in the sea or lakes: bag system
- in man made ponds on land: pond system
- in tanks: tank system

In these systems either zooplankton is developing in the mesocosm system (with or without fertilization), or is additionally pumped in from the surrounding waters.

5.3.2.1. Pold system (2-60 m³)

The pold system is an isolated water volume, such as an isolated bay, or a branch of a fjord or a lagoon. Before each production cycle the enclosed water volume is treated with chemicals (rotenone) to make the enclosure free from predators, including fish larvae. Predators can also be removed from the pold system by emptying, drying and refilling the enclosure with filtered seawater (200-500 μm). The copepod resting eggs can resist the rotenone treatment and will ensure a zooplankton bloom in the mesocosm. After the treatment of the pold system, and fertilization of the enclosure or lagoon, inoculation with microalgae should be carried out to promote a phytoplankton bloom. When needed, zooplankton harvested from nature can be introduced into the system. When a sufficient density of copepod nauplii is reached (50-200 l^{-1}), the pold system is ready for stocking with fish larvae at stocking densities of 1-2 larvae per litre (i.e. for turbot or cod). Each day the zooplankton density must be checked and in case of zooplankton depletion, fresh (filtered) zooplankton, *Artemia* nauplii or artificial feeds (at later stages) should be added to the mesocosm. When sufficiently old, the fry can be concentrated, caught and transported to nursery or grow-out systems.

5.3.2.2. Bag system (50-200 m³)

The bag system (Fig. 5.8.) is a simplification of the former system, since the isolation of a large water volume is easier achieved: black or transparent polyethylene or PVC bags are used tied to a floating wharf. These bags have a conical bottom with an outward hose from the bottom to the surface for water renewal. Two internal flexible hoses with plankton filter maintain the water level in the bags (Fig. 5.8.); the bags having been filled with filtered (100-200 μm) seawater and inoculated with microalgae. The enclosed water is then fertilized with an agricultural fertilizer to promote algal bloom, after which the screened zooplankton (copepods) can be introduced. When sufficient zooplankton production is achieved (50-200 copepod nauplii l^{-1} or 100-500 microzooplankters l^{-1}), fish larvae can be released into the bags at a stocking density of 1-3 larvae l^{-1} .

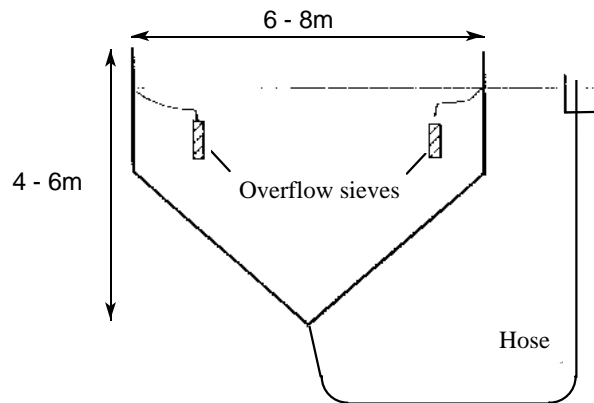

Figure 5.8. Plastic bag system for larval rearing (modified from Tilseth *et al.*, 1992).

As before the daily control of the zooplankton density is advisable and should be between 50-500 zooplankters.

In case of depletion, fresh (filtered) zooplankton (Fig. 5.9.), *Artemia* or artificial feeds (in later stages) should be added. Water exchange is necessary if oxygen saturation drops below 5 mg.l⁻¹ (> 80% saturation) or pH and ammonia reach unfavourable levels. Normally 1-2% of the bag volume is exchanged per day for the first two weeks, and thereafter water exchange increased to 10-100% bag volume per day. These bags are currently being used in Norway to produce turbot and halibut fingerlings (with an overall survival rate of 20% and 40-50%, respectively) and cod fingerlings.

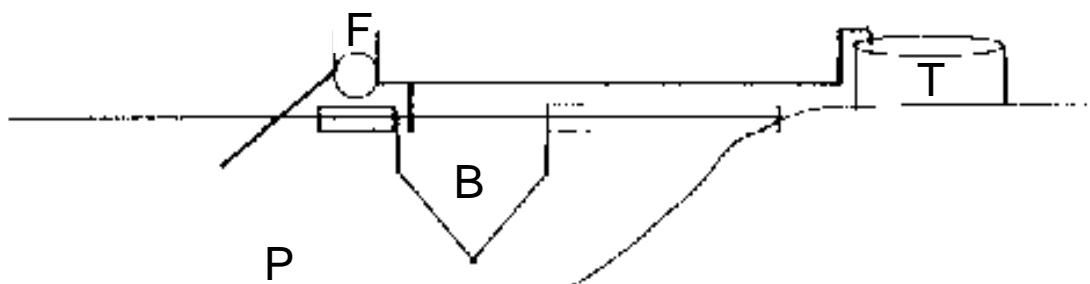

Figure 5.9. Automatic supplementation of zooplankton in bag system. (P): surrounding water with good zooplankton production; (F): filter for concentrating zooplankton; (B): bag system and (T): tank (modified from Tilseth *et al.*, 1992).

5.3.2.3. Pond system

Another variation on this principal is to use dug-out land-based ponds. The advantage of such a system is that it is very easy and cheap in construction, maintenance and operation. The ponds are dug out and covered with plastic liner to prevent leaching. After emptying and cleaning, the ponds are exposed to direct sun light for at least 4 days. The fish can be harvested and transferred to the on-growing ponds when attaining the appropriate size (sea

bream: 10 mm). Before harvesting, the bottom of the tank is carefully cleaned in order to remove sedimentated organic material by siphoning. Afterwards, the water level is lowered and the fish can be fished out using a net. It has been shown that, for instance, larvae of herring, plaice, turbot, goby and cod can easily be grown through metamorphosis in this way. A good review of pond management prior to and during the larval stocking of red drum is described by Sturmer (1987). The number of fry which can be grown per surface unit of pond area determines the efficiency of this method. For carp larvae possible stocking densities of 5 to 600.m⁻² have been reported. It is suggested that the quality of zooplankton necessary to ensure the survival of larval carps should be 1.5 to 3.0 food organisms.ml⁻¹ at the beginning. Two to three days later when the larvae have learned to hunt for food more efficiently the concentration may decrease to half of that. These marine systems are currently in use in Norway as well as in Denmark. In China over 95% of the 10 million tonnes of cyprinid fish produced annually are originating from fresh water mesocosm systems.

5.3.2.4. Tank system

Cement tanks up to 50 m³ are emptied and cleaned with HCl solution to dissolve calcareous hidings of Serpulidae or shells. Thereafter the tanks are exposed to sun light for at least 4 days and then filled with filtered seawater rich in phyto- and zooplankton. The tanks are then fertilized with N and P to promote phytoplankton blooms. Recommended fertilization rates for gilthead seabream culture in Crete waters being 0.5-2.0 g N.m⁻³ and a N/P ratio 5-10:1. Fish larvae are generally introduced into the mesocosm tanks after they have absorbed their yolk sac and when the size of the plankton population is adequate to support the fish population. It follows, therefore, that timing of artificial spawning and incubation is of the utmost importance. Stocking densities for gilthead sea bream and European sea bass are generally 0.1-0.5 larvae.l⁻¹ and 1 larva.l⁻¹, respectively. The monitoring of the tank system should include both the measurement of abiotic (temperature, salinity, dissolved oxygen, pH, light intensity and nutrient concentrations) and biotic (plankton concentrations and composition, fish biometrics and condition) parameters.

An example of a super-intensive tank system is the Maximus system (Maximus A/S, Denmark), which produces calanoid copepods in large tanks as the major live feed. The whole system is intensified and therefore requires steady control and continuous re-adjustment by a "Computer Supported Subjective Decision Manipulation Programme" (Fig. 5.10.).

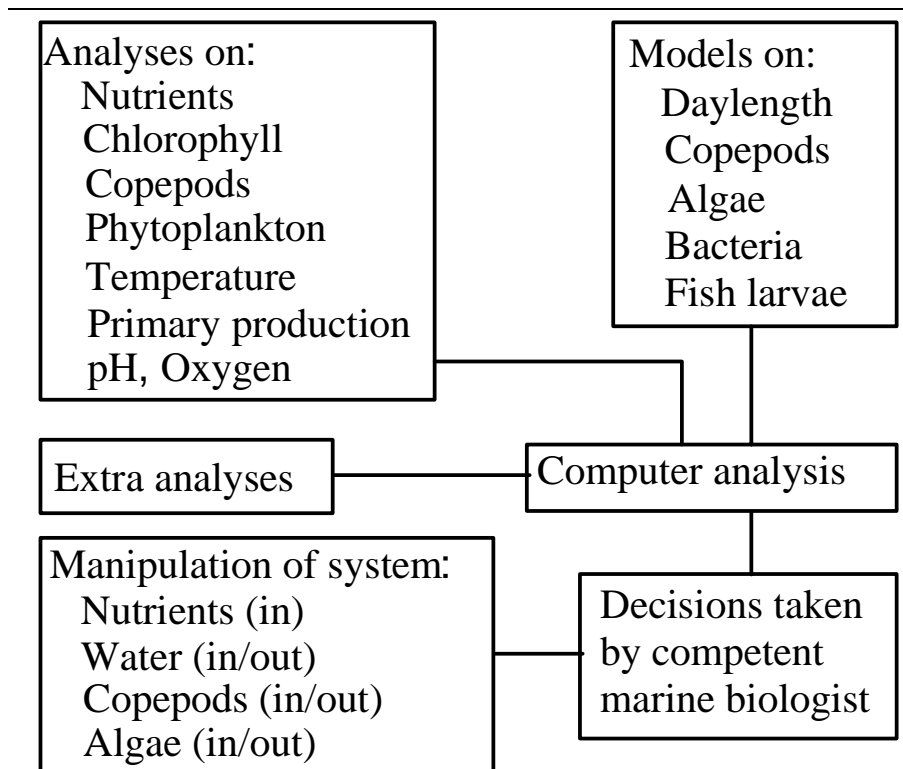

Figure 5.10. Schematic operating model of the intensive tank system (modified from Urup, 1994).

Some of these tanks are stocked with fish larvae, others serve solely for copepod production. The main idea of the Maximus system is to control the abiota (nutrient level, pH, temperature, light intensity, ...) and biota (phytoplankton and copepod production, number of predators, bacterial turn-over, regeneration of nutrients from copepods and fish larvae) in such a way that the production of one trophic level matches the predation by the higher trophic level. This makes the management of such a system very difficult and requires automation. The disadvantage of such a system is that it is very expensive to build and operate. In 1992 Maximus A/S produced 700,000 turbot fingerlings with this system, but this can realistically be increased to 1.5 to 2.0 million fingerlings (Urup, 1994).

5.3.3. Mesocosm protocol

The mesocosm systems are prepared as follows: they are treated with chemicals to kill predators or they are set dry for at least 4 days, and if needed cleaned with HCl to remove the calcareous cases of various organisms. These culture systems are then filled with adjacent seawater rich in phyto- and zooplankton, using 350-500 μ m filters, so as to prevent predators from entering the system. The water is then fertilized; recommended quantities are 0.5-2 g N.m⁻³ and a N/P ratio of 5-10 for seawater systems. For freshwater systems the following procedure can be used: poultry manure (40g.m⁻³) together with additional fertilization every 3 days with a chemical fertilizer composed of 1.6 g ammonium sulfate, 1.08 g urea, 2.4 g superphosphate of lime.

In the mesocosms different plankton blooms will develop one after the other, and this process is called succession. The first blooming organism will usually be the diatom group, that will soon collapse due to depletion of silicates (only in closed systems: pond and tank system). This bloom is then usually followed by a bloom of nanoflagellates and

dinoflagellates, which on their turn is followed by a bloom of ciliates and rotifers. These organisms are important during the first feeding period of fish larvae and also form an additional food source to the copepod nauplii N1. Only when an adequate population of copepods is established can fish larvae be stocked. For *Acartia tsuensis* maximum values of abundance during the culture can go up to 1,300 nauplii.l⁻¹, 590 copepodites.l⁻¹ with a maximum egg production rate of 350 eggs.l⁻¹.day⁻¹.

The time of introduction of fish larvae into the mesocosms is at startfeeding, but only when adequate plankton populations are established. Synchronization can be carried out by:

- Manipulating the time of artificial spawning
- Regulating the rate of development of fish through temperature; i.e. yolksac absorption in sea bream is completed in 3 days at 21°C, 4 days at 18°C and more than 5 days at less than 17°C
- Control over the plankton population growth rate which is related to ambient environmental conditions (temperature, light intensity and nutrients); for example, in Crete plankton populations in the mesocosms reached appropriate densities to stock fish larvae in 12-14 days at 17-22°C and about 20 days at 13-16°C.

The stocking density of the fish larvae depends on the species. For example, for gilthead seabream and the European sea bass low stocking densities are recommended: (0.1-0.5 larva.l⁻¹ and 1 larva.l⁻¹, respectively. The newly-hatched larvae are gently transferred in large containers with sufficient aeration for transportation to the mesocosms. Gradual equalization of the temperature and water salinity in the containers to the mesocosms is needed, after which the larvae can be gently released into the mesocosms.

During the rearing period abiotic and biotic parameters must be frequently monitored. Water analysis is preferentially carried out each day, and the estimation of plankton population growth rate every two days by taking samples and counting under a binocular microscope. As soon as the food consumption of the growing larval biomass exceeds the net zooplankton production, new zooplankton, rotifers, *Artemia* or artificial feeds are added. Fish larvae are sampled once or twice a week and their length and weight are measured.

The fish can be harvested and transferred to the ongrowing system after they have reached the appropriate size (gilthead seabream: 10 mm). Therefore, the bottom of the system is carefully cleaned by siphoning sedimentated organic material, and afterwards the water level is lowered and the fish readily fished out with a net.

Possible problems or difficulties are:

- Synchronization of mesocosm preparations and fish egg production.
- High oxygen concentrations during periods of high light intensity causing mortality due to over-inflation of the swimbladder (gas-bubble disease)
- Formation of a surface lipid film due to excessive phytoplankton production, preventing swimbladder inflation (i.e. need for surface skimmers)

5.3.4. Comparison to intensive methods

In contrast to mesocosm systems intensive hatcheries require high technology and therefore have a high investment and energy cost. Since the intensive hatchery has to produce sufficient amounts of live food and keep the cultures on during periods of low demand, high functional costs and highly specialized personnel is required. In addition, intensive hatcheries are characterized by the frequent rearing of batches of larvae, with relatively low survival rates (Table 5.8.).

Table 5.8. Comparison of intensive and mesocosm rearing methods.		
	Intensive systems	Mesocosm systems
Installations and equipment	high technology	simple technology
Investment cost	very high	low
Personnel	highly specialized	moderately specialized
Water volume used	small	large
Food used	<i>Brachionus/Artemia</i>	natural plankton
Consumables cost	high	low
Energy required	high	negligible
Operational cost	very high	very low
Production	very high	low
Survival rate	low	moderate high
Growth rate	moderate	high
Production quality (swimbladder/skeletal deformations)	poor to moderate	good to excellent
Disease control	moderate	very low
Subsequent growth rate		20 % faster
Risk	high	low
Expected profit	very high	low
Conformity with wild standards	low	high

Mesocosm systems have considerable lower costs because of the simplicity of the installation, and require little control over environmental conditions. In addition the use of mesocosm systems has the advantage to be less expensive/labourious than the intensive production systems for copepods and they are self-maintaining systems, which makes them less vulnerable to technical failures, e.g. electric failures. Furthermore, the quality of the produced fry is better since the fish larvae are reared on a more diversified and therefore complete diet, resulting in higher production outputs per batch of larvae; e.g. for turbot malpigmentation is less than 0.1%. A well-managed semi-extensive mesocosm in a 60 m³ enables a production of 25-50,000 sea bream or 50-100,000 sea bass fry, within 25-40 days, and with a good quality of fry (<5% deformaties or non-inflated swimbladder). In Greece mesocosm-reared sea bass fry gave a 1 to 3 months faster production cycle in comparison to intensive cultured sea bass.

5.4. Literature of interest

- Barnabé, G. 1990. Harvesting zooplankton. In: Aquaculture. Vol. 1. G. Barnabé (Ed). Ellis Horwood Ltd., UK, pp 265-272.
- Fukusho, K. 1980. Mass production of a copepod, *Tigriopus japonicus* in combination culture with a rotifer *Brachionus plicatilis*, fed w-Yeast as a food source. Bulletin of the Japanese Society of Scientific Fisheries, 46(5): 625-629.
- Fukusho, K., Arakawa, T. and Watanabe, T. 1980. Food value of a copepod, *Tigriopus japonicus*, cultured with w-Yeast for larvae and juveniles of mud dab *Limanda yokohamae*. Bulletin of the Japanese Society of Scientific Fisheries, 46(4): 499-503.
- Kuhlmann, D., Quantz, G. and Witt, U. 1981. Rearing of turbot larvae (*Scophthalmus maximus* L.) on cultured food organisms and post-metamorphosis growth on natural and artificial food. Aquaculture, 23 : 183-196.
- Kuroshima, R., Sato, M., Yoshinaka, R. and Ikeda, S. 1987. Nutritional quality of the wild zooplankton as a living feed for fish larvae. The Suisanzoshoku 35(2): 113-117.
- Machacek, J. 1991. Zooplankton collecting, sorting, transport and storage. Report of the Research Institute of Fish Culture and Hydrobiology, Vodnany, Czechoslovakia, 12 pp.
- Naess, T. and Bergh, O. 1994. Calanoid copepod resting eggs can be surface-disinfected. Aquacultural Engineering, 13: 1-9.
- Nellen, W., Quantz, G., Witt, U., Kuhlmann, D. and Koske, P.H. 1981. Marine fish rearing on the base of an artificial food chain. In: European Mariculture Society, Special Publication No. 6, Bredene, Belgium, pp 133-147.
- Nellen, W. 1986. Live animal food for larval rearing in aquaculture. Non-*Artemia* organisms. In: Realism in Aquaculture: Achievements, Constraints, Perspectives. Bilio, M., H. Rosenthal and C.J. Sindermann, (Eds). European Aquaculture Society, Bredene, Belgium, pp 215-249.
- Oiestad, V. 1983. Growth and survival of herring larvae and fry (*Clupea harengus* L.) exposed to different feeding regimes in experimental ecosystems: outdoor basin and plastic bags. PhD. Dissertation, University Bergen, 299 pp.

- Pederson, B.H. 1984. The intestinal evacuation rates of larval herring (*Clupea harengus* L.) preying on wild zooplankton. *Dana*, 3: 21-30.
- Støttrup, J.G., Richardson, K., Kirkegaard, E. and Pihl, N.J. 1986. The cultivation of *Acartia tonsa* Dana for use as a live food source for marine fish larvae. *Aquaculture*, 52: 87-96.
- Sturmer, L.N. 1987. Zooplankton composition and dynamics in fingerling red drum rearing ponds. In: *Manual on red Drum Aquaculture*. Chamberlain, G.W., R.J. Miget and M.G. Haxby, (Eds). Sea Grant Technical Report, Corpus Christi-Texas, USA, pp III-53-74.
- Tilseth, S., Blom, G. and Naas, K. 1992. Recent progress in research and development of marine cold water species for aquaculture production in Norway. *Journal of the World Aquaculture Society*, 23(4): 277-285.
- Urup, B. 1994. Methods for the production of turbot fry using copepods as food. In: *Turbot Culture: Problems and Prospects*. Lavens, P. and R.A.M. Remmerswaal, (Eds.). European Aquaculture Society, Special Publication No. 22, Gent, Belgium, pp 47-53.

6. CLADOCERANS, NEMATODES AND TROCHOPHORA LARVAE

Daan Delbare and Philippe Dhert

Laboratory of Aquaculture & Artemia Reference Center
University of Gent, Belgium

6.1. *Daphnia* and *Moina*

6.1.1. Biology and life cycle of *Daphnia*

Daphnia is a frequently used food source in the freshwater larviculture (i.e. for different carp species) and in the ornamental fish industry (i.e. guppies, sword tails, black mollies and plattys etc.)

Daphnia belongs to the suborder Cladocera, which are small crustaceans that are almost exclusively living in freshwater. The carapace encloses the whole trunk, except the head and the apical spine (when present). The head projects ventrally and somewhat posteriorly in a beak-like snout. The trunk appendages (five or six pairs) are flattened, leaf-like structures that serve for suspension feeding (filter feeders) and for locomotion. The anterior part of the trunk, the postabdomen is turned ventrally and forward and bears special claws and spines to clean the carapace (Fig. 6.1.). Species of the genus *Daphnia* are found from the tropics to the arctic, in habitats varying in size from small ponds to large freshwater lakes. At present 50 species of *Daphnia* are reported worldwide, of which only six of them normally occur in tropical lowlands.

The adult size is subjected to large variations; when food is abundant, growth continues throughout life and large adults may have a carapace length twice that of newly-mature individuals. Apart from differences in size, the relative size of the head may change progressively from a round to helmet-like shape between spring and midsummer. From midsummer to fall the head changes back to the normal round shape. These different forms are called cyclomorphs and may be induced, like in rotifers, by internal factors, or may be the result from an interaction between genetic and environmental conditions.

Normally there are 4 to 6 Instar stages; *Daphnia* growing from nauplius to maturation through a series of 4-5 molts, with the period depending primarily on temperature (11 days at 10°C to 2 days at 25°C) and the availability of food. *Daphnia* species reproduce either by cyclical or obligate parthenogenesis and populations are almost exclusively female. Eggs are produced in clutches of two to several hundred, and one female may produce several clutches, linked with the molting process. Parthenogenetic eggs are produced ameiotically and result in females, but in some cases males can appear. In this way the reproductive pattern is similar to rotifers, where normally parthenogenetic diploid eggs are produced. The parthenogenetic eggs (their number can vary from 1 to 300 and depends largely upon the size of the female and the food intake) are laid in the brood chamber shortly after ecdysis and hatch just before the next ecdysis. Embryonic development in cladocerans occurs in the broodpouch and the larvae are miniature versions of the adults. In some cases the embryonic period does not correspond with the brood period, and this means that the larvae are held in the brood chamber even after the embryonic period is completed, due to postponed ecdysis (environmental factors). For different species the maturation period is remarkably uniform at given temperatures, ranging from 11 days at 10°C to only 2 days at 25°C.

Factors, such as change in water temperature or food deprivation as a result of population increase, may induce the production of males. These males have one or two gonopores, which open near the anus and may be modified into a copulatory organ. The male clasps the

female with the first antennae and inserts the copulatory processes into the single, median female gonopore. The fertilized eggs are large, and only two are produced in a single clutch (one from each ovary), and are thick-shelled: these resting or dormant eggs being enclosed by several protective membranes, the ephippium. In this form, they are resistant to desiccation, freezing and digestive enzymes, and as such play an important role in colonizing new habitats or in the re-establishment of an extinguished population after unfavourable seasonal conditions.

6.1.2. Nutritional value of *Daphnia*

The nutritional value of *Daphnia* depends strongly on the chemical composition of their food source. However, since *Daphnia* is a freshwater species, it is not a suitable prey organism for marine organisms, because of its low content of essential fatty acids, and in particular (n-3) HUFA. Furthermore, *Daphnia* contains a broad spectrum of digestive enzymes such, as proteinases, peptidases, amylases, lipases and even cellulase, that can serve as exo-enzymes in the gut of the fish larvae.

6.1.3. Feeding and nutrition of *Daphnia*

The filtering apparatus of *Daphnia* is constructed of specialized thoracic appendages for the collection of food particles. Five thoracic limbs are acting as a suction and pressure pump. The third and fourth pair of appendages carry large filter-like screens which filter the particles from the water. The efficiency of the filter allows even the uptake of bacteria (approx. 1 μm). In a study on the food quality of freshwater phytoplankton for the production of cladocerans, it was found that from the spectrum blue-greens, flagellates and green algae, *Daphnia* performed best on a diet of the cryptomonads, *Rhodomonas minuta* and *Cryptomonas* sp., containing high levels of HUFA (more than 50% of the fatty acids in these two algae consisted of EPA and DHA, while the green algae were characterized by more 18:3n-3). This implies that the long-chained polyunsaturated fatty acids are important for a normal growth and reproduction of *Daphnia*. Heterotrophic microflagellates and ciliates up to the size of *Paramecium* can also be used as food for *Daphnia*. Even detritus and benthic food can be an important food source, especially when the food concentration falls below a certain threshold. In this case, the water current produced by the animals swimming on the bottom whirls up the material which is eventually ingested. Since daphnids seem to be non-selective filter feeders (*i.e.*, they do not discriminate between individual food particles by taste) high concentrations of suspended material can interfere with the uptake of food particles.

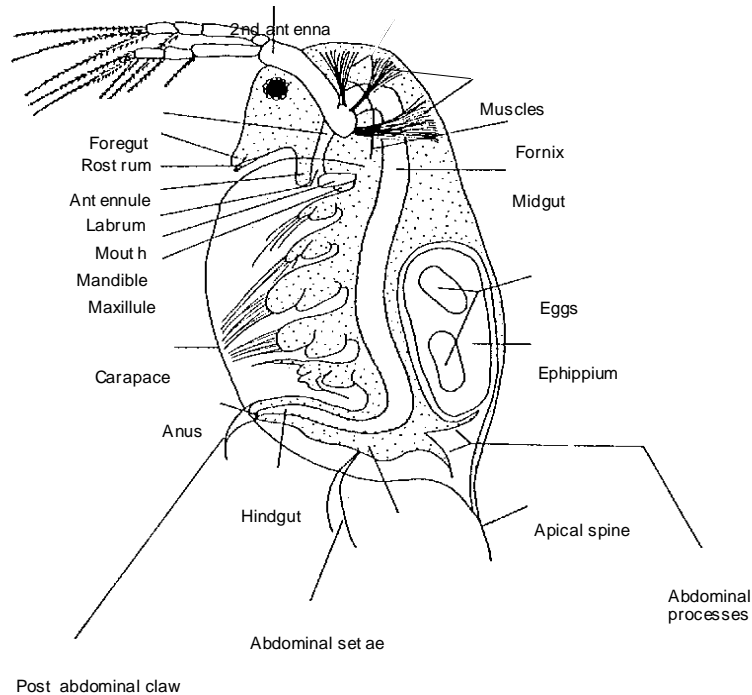

Figure 6.1. Schematic drawing of the internal and external anatomy of *Daphnia*.

6.1.4. Mass culture of *Daphnia*

6.1.4.1. General procedure for tank culture

Daphnia is very sensitive to contaminants, including leaching components from holding facilities. When plastic or other polymer containers are used, a certain leaching period will be necessary to eliminate toxic compounds.

The optimal ionic composition of the culture medium for *Daphnia* is unknown, but the use of hard water, containing about 250 mg.l^{-1} of CO_3^{2-} , is recommended. Potassium and magnesium levels should be kept under 390 mg.l^{-1} and $30\text{-}240 \text{ }\mu\text{g.l}^{-1}$, respectively. Maintenance of pH between 7 to 8 appears to be important to successful *Daphnia* culture. To maintain the water hardness and high pH levels, lime is normally added to the tanks. The optimal culture temperature is about 25°C and the tank should be gently aerated to keep oxygen levels above 3.5 mg.l^{-1} (dissolved oxygen levels below 1.0 mg.l^{-1} are lethal to *Daphnia*). Ammonia levels must be kept below 0.2 mg.l^{-1} .

Inoculation is carried out using adult *Daphnia* or resting eggs. The initial density is generally in the order of 20 to 100 animals per litre.

Normally, optimal algal densities for *Daphnia* culture are about 10^5 to 10^6 cells. ml⁻¹ (larger species of *Daphnia* can support 10^7 to 10^9 cells.ml⁻¹). There are two techniques to obtain the required algal densities: the detrital system and the autotrophic system:

6.1.4.2. Detrital system

The “stable tea” rearing system is a culture medium made up of a mixture of soil, manure and water. The manure acts as a fertilizer to promote algal blooms on which the daphnids feed. One can make use of fresh horse manure (200 g) that is mixed with sandy loam or garden soil (1 kg) in 10 l pond water to a stable stock solution; this solution diluted two to four times can then be used as culture medium. Other fertilizers commonly used are: poultry manure (4 g.l⁻¹) or cow-dung substrates. This system has the advantage to be self-maintaining and the *Daphnia* are not quickly subjected to deficiencies, due to the broad spectrum of blooming algae. However, the culture parameters in a detrital system are not reliable enough to culture *Daphnia* under standard conditions, i.e. overfertilization may occur, resulting in anoxic conditions and consequently in high mortalities and/or ephippial production.

6.1.4.3. Autotrophic system

Autotrophic systems on the other hand use the addition of cultured algae. Green water cultures (10^5 to 10^6 cells.ml⁻¹) obtained from fish pond effluents are frequently used but these systems show much variation in production rate mainly because of the variable composition of algal species from one effluent to another. Best control over the culture medium is obtained when using pure algal cultures. These can be monocultures of e.g. algae such as *Chlorella*, *Chlamydomonas* or *Scenedesmus*, or mixtures of two algal cultures. The problem with these selected media is that they are not able to sustain many *Daphnia* generations without the addition of extra vitamins to the *Daphnia* cultures. A typical vitamin mix is represented in Table 6.1.

Table 6.1. A vitamin mix for the monospecific culture of *Daphnia* on *Selenastrum*, *Ankistrodesmus* or *Chlamydomonas*. One ml of this stock solution has to be added to each litre of algal culture medium (Goulden *et al.*, 1982).

Nutrient	Concentration of stock solution (µg.l ⁻¹)
Biotin	5
Thiamine	100
Pyridoxine	100
Pyridoxine	3
Calcium Panthothenate	250
B ₁₂ (as mannitol)	100
Nicotinic acid	50
Nicotinamide	50
Folic acid	20
Riboflavin	30
Inositol	90

To calculate the daily algal requirements and to estimate the harvesting time, regular sampling of the population density must be routinely undertaken. Harvesting techniques can be non-selective irrespective of size or age group, or selective (only the medium sized daphnids are harvested, leaving the neonates and matured individuals in the culture tank).

Mass cultivation of *Daphnia magna* can also be achieved on cheap agro-industrial residues, like cotton seed meal (17 g.l⁻¹), wheat bran (6.7 g.l⁻¹), etc. Rice bran has many advantages in comparison to other live foods (such as microalgae): it is always available in large quantities, it can be purchased easily at low prices, it can be used directly after simple treatment (micronisation, defatting), it can be stored for long periods, it is easy to dose, and it has none of the problems involved in maintenance of algal stocks and cultures.

In addition to these advantages, there is also the fact that rice bran has a high nutritional value; rice bran (defatted) containing 24% (18.3%) crude protein, 22.8% (1.8%) crude fat, 9.2% (10.8%) crude fibre, and being a rich source of vitamins and minerals. *Daphnia* can be grown on this food item for an unlimited number of generations without noticeable deficiencies.

Defatted rice bran is preferred above raw rice bran because it prevents hydrolysis of the fatty acids present and, consequently, rancidity of the product. Micronisation of the bran into particles of less than 60 µm is generally carried out by treating an aqueous suspension (50 g.l⁻¹) with a handmixer and filtering it through a 60 µm sieve, or by preparing it industrially by a dry mill process. The suspension is administered in small amounts throughout a 24 h period: 1 g of defatted rice bran per 500 individuals for two days (density: 100 animals.l⁻¹). The food conversion ratio has an average of 1.7, which implies that with less than 2 kg of dry rice bran approximately 1 kg wet daphnid material can be produced (with a 25% water renewal per week; De Pauw *et al.*, 1981).

6.1.4.4. General procedure for pond culture

Daphnia can also be produced in ponds of at least 60 cm in height. To produce 1 ton of *Daphnia* biomass per week, a 2500 m³ culture pond is required. The pond is filled with 5 cm of sun-dried (for 3 days) soil to which lime powder is added at a rate of 0.2 kg lime powder per ton soil. After this the pond is then filled with water up to 15 cm. Poultry manure is added to the ponds on the 4th day at a rate of 0.4 kg.m⁻³ to promote phytoplankton blooms. Fertilization of the pond with organic manure instead of mineral fertilizers is preferred because cladocerans can utilize much of the manure directly in the form of detritus. On day 12 the water level is raised to 50 cm and the pond is fertilized a second time with poultry manure (1 kg.m⁻³). Thereafter, weekly fertilization rates are maintained at 4 kg poultry manure per m³. In addition, fresh cow dung may also be used: in this instance a suspension is prepared containing 10 g.l⁻¹, which is then filtered through a 100 µm sieve. During the first week a 10 l extract is used per day per ton of water; the fertilization increasing during the subsequent weeks from 20 l.m⁻³.day⁻¹ in the second week to 30 l.m⁻³.day⁻¹ in the following weeks.

The inoculation of the ponds is carried out on the 15th day at a rate of 10 daphnids per litre. One month after the inoculation, blooms of more than 100 g.m⁻³ can be expected. To maintain water quality in these ponds, fresh hard water can be added at a maximum rate of 25% per day. Harvesting is carried out by concentrating the daphnids onto a 500 µm sieve. The harvested biomass is concentrated in an aerated container (< 200 daphnids.l⁻¹). In order to separate the daphnids from unfed substrates, exuviae and faecal material, the content of the container is brought onto a sieve, which is provided with a continuous circular water flow. The unfed particles, exuviae and faeces will collect in the centre on the bottom of the sieve, while the daphnids remain in the water column. The unwanted material can then be removed

by using a pipette or sucking pump. Harvesting can be complete or partial; for partial harvesting a maximum of 30% of the standing crop may be harvested daily.

6.1.4.5. Contamination

Daphnia cultures are often accidentally contaminated with rotifers. In particular *Brachionus*, *Conochilus* and some bdelloids may be harmful, (i.e. *B. rubens* lives on daphnids and hinders swimming and food collection activities). *Brachionus* is simply removed from the culture by flushing the water and using a sieve of appropriate mesh size as *Daphnia* is much bigger than *Brachionus*. *Conochilus*, on the other hand, can be eliminated by adding cow dung to the culture (lowering the oxygen levels). Bdelloids are more difficult to remove from the culture since they are resistant to a wide range of environmental conditions and even drought. However, elimination is possible by creating strong water movements, which bring the bdelloids (which are bottom dwellers) in the water column, and then removing them by using sieves.

6.1.5. Production and use of resting eggs

Resting eggs are interesting material for storage, shipment and starting of new *Daphnia* cultures. The production of resting eggs can be initiated by exposing a part of the *Daphnia* culture to a combination of stressful conditions, such as low food availability, crowding of the animals, lower temperatures and short photoperiods. These conditions are generally obtained with aging populations at the end of the season. Collection of the ephippia from the wild can be carried out by taking sediment samples, rinsing them through a 200 µm sieve and isolating the ephippia under a binocular microscope. Normally, these embryos remain in dormancy and require a diapause inhibition to terminate this status, so that they can hatch when conditions are optimal. Possible diapause termination techniques are exposing the ephippia to low temperatures, darkness, oxygen and high carbon dioxide concentrations for a minimal period of several weeks (Davison, 1969).

There is still no standard hatching procedure for *Daphnia*. Generally the hatching process is stimulated by exposing the ephippia to higher temperatures (17-24°C), bright white light (70 W.m⁻²), longer photoperiods and high levels of dissolved oxygen. It is important, however, that these shocks are given while the resting eggs are still in the ephippium. After the shock the eggs may be removed from the ephippium. The hatching will then take place after 1-14 days.

6.1.6. Use of *Moina*

Moina also belongs to the Cladocera and many of the biological and cultural characteristics that have been discussed for *Daphnia* can be applied to *Moina*.

Moina thrives in ponds and reservoirs but primarily inhabits temporary ponds or ditches. The period to reach reproductive maturity takes four to five days at 26°C. At maturity clear sexual dimorphic characteristics can be observed in the size of the animals and the antennule morphology. Males (0.6-0.9 mm) are smaller than females (1.0-1.5 mm) and have long graspers which are used for holding the female during copulation. Sexually mature females carry only two eggs enclosed in an ephippium which is part of the dorsal exoskeleton.

Moina is of a smaller size than *Daphnia*, with a higher protein content, and of comparable economic value. Produced biomass is successfully used in the larviculture of rainbow trout, salmon, striped bass and by tropical fish hobbyists who also use it in a frozen form to feed over sixty fresh and salt water fish varieties. The partial replacement of *Artemia* by *Moina micrura* was also reported to have a positive effect during the larviculture of the freshwater prawn *Macrobrachium rosenbergii* (Alam, 1992).

Enrichment of *Moina* can be carried out using the direct method, by culturing them on baker's yeast and emulsified fish or cuttlefish liver oils. Experiments have shown that *Moina* takes up (n-3) HUFA in the same way, although slower, than rotifers and *Artemia* nauplii, reaching a maximum concentration of around 40% after a 24 h-feeding period.

6.2. Nematodes

The use of the free living nematode, *Panagrellus redivivus* as larval food has been demonstrated successfully for several species, including *Crangon crangon*, juvenile king shrimp (*Penaeus blebejus*), common carp (*Cyprinus carpio*) and silver carp (*Hypophthalmichthys molitrix*).

P. redivivus is a suitable larval live food since it is small (50 µm in diameter). Moreover, it has an amino acid profile that matches that of *Artemia* (Table 6.2.), while its EPA and DHA content is respectively nearly a third and almost the same or a little higher of that of *Artemia*, (Table 6.3.). *P. redivivus* can be cultured very simply in trays filled with 70 g of flour (10.8% protein) per 100 cm², the latter kept humid by spraying with water. The culture medium is supplemented weekly with 0.5 g baker's yeast per 100 cm², which should inhibit the growth of nematophage fungi. The containers should be stored in a well ventilated room at a temperature of 20-23°C. Contamination by insects can be prevented by covering the containers with cloth. The nematodes are harvested daily for about 53 days using the same culture medium by removal from the substrate with a spatula (Fig. 6.2.). A maximum daily production of 75-100 mg per 100 cm² is reached at week 3. For smaller cultures the nematodes can be harvested by adding a small quantity of distilled water to the trays and decanting the suspended nematodes. The nematodes have a short generation time ranging from 5-7 days and a high fecundity.

Table 6.2. Comparison between the protein and amino acid composition of *P. redivivus* and *Artemia* (expressed as weight % of total amino acids) (Watanabe & Kiron, 1994).

	<i>P. redivivus</i>	<i>Artemia</i>
Protein	48.3	61.6
Amino acids		
ILE	5.1	3.8
LEU	7.7	8.9
MET	2.2	1.3
PHE	4.7	4.9
TYR	3.2	5.4
THR	4.7	2.5
TRY	1.5	
VAL	6.4	4.7
LYS	7.9	8.9
ARG	6.6	7.3
HIS	2.9	1.9
ALA	8.8	6.0
ASP	11.0	11.2
GLU	12.8	12.9
GLY	6.4	5.0
PRO	5.4	6.9
SER	3.7	6.7

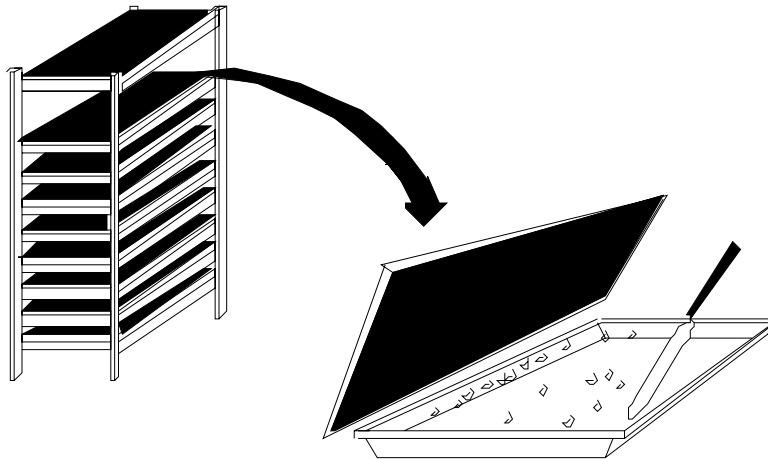

Figure 6.2. Culture technique for mass production of *Panagrellus redivivus*.

The nutritional quality of nematodes can be enhanced by the use of the bio-encapsulation technique. Enrichment is simply carried out by adding the product to the culture medium (direct enrichment) or by bringing the nematodes in an emulsion of the product (indirect enrichment). Rouse *et al.* (1992) used for the direct enrichment a culture medium which was fortified with a 10% fish oil emulsion, obtaining nematodes that had a significantly higher total lipid content and elevated levels of (n-3) HUFA (i.e. 11.2% and 4.8% respectively; Table 6.3.).

The bioencapsulation technique can also be used to fortify the nematodes with therapeutics (bio-medication). For example, nematodes can be placed in 1 l beakers with 500 ml of fresh artificial seawater and 5 g of Romet-30 premix (Hoffman - La Roche, Switzerland) containing 25 % sulfadimethoxine, 5 % ormetoprim and 70 % rice bran carrier. After a 4 h boost period, during which the nematodes have accumulated 0.25 μg of the drug per individual ($0.1 \mu\text{g} \cdot \text{ind.}^{-1}$ for *Artemia* nauplii), the nematodes are separated from the antibiotic carrier by resuspension in seawater and centrifugation at 1500 rpm for 10 min. After a 10-20 min period the animals have migrated to the top of the tube, where they can be collected with the use of a pipet onto a 100 μm mesh screen. After rinsing with seawater, the nematodes can then be fed to the larval predators.

Table 6.3. Comparison between the fatty acid composition of *P. redivivus* non-enriched and directly enriched (expressed as weight % of total lipids) (Rouse *et al.*, 1992).

	Non-enriched	enriched
12:0	0.40	0.20
14:0	2.73	4.67
14:1n-5	0.19	1.52
16:0	11.05	12.89
16:1n-7	4.71	10.46
17:0	0.89	0.42
18:0	7.58	4.70
18:1n-9	8.42	15.05
18:1n-7	11.15	11.28
18:2n-6	28.38	9.91
18:3n-3	5.03	9.28
20:0	1.29	0.23
20:1n-9	0.50	1.02
20:3n-3	0.09	0.44
20:4n-6	6.37	4.64
20:5n-3	4.56	7.35
22:0	1.80	0.47
22:1n-9	3.98	1.52
22:2n-6	0.11	0.78
22:4n-6	0.00	0.08
22:5n-3	0.00	0.11
22:6n:3	0.15	3.25

6.3. Trochophora larvae

6.3.1. Introduction

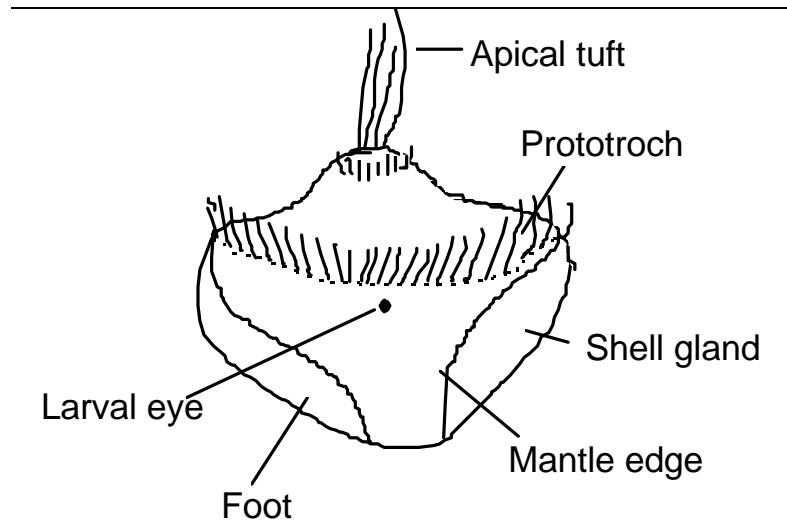

Figure 6.3. General scheme of a trochophora larva.

For some marine fish species (i.e. siganids, groupers, snappers) very small zoo-plankton, such as trochophora larvae (Fig. 6.3.) need to be used as a starter feed, since the commonly used rotifers are too big. Trochophora larvae of the Pacific oyster *Crassostrea gigas* are 50 μm in size and free-swimming (slow circular swimming pattern) ciliated organisms which have a high nutritional value for marine fish larvae. For example, trochophora larvae may contain up to 15% (of total fatty acid) of both EPA and DHA.

6.3.2. Production of trochophora larvae

6.3.2.1. Mussel larvae

Unripe mussels are brought in acclimation tanks with flowing seawater, after the removal of excess epifauna. The temperature is kept at 10-12°C for a minimum period of two weeks. During the acclimation period the mussels are fed on algal suspensions of *Dunaliella tertiolecta* and/or *Chlamydomonas coccooides*. The spawning of the animals is induced by bringing the conditioned mussels in a plastic bucket and shaking them violently for 2 to 3 min. After returning the stimulated mussels to the spawning tanks (lightly aerated static seawater at 14-15°C) spawning takes place within 12 h. The trochophora larvae can be harvested after 24-48 h by concentrating them on a 25 μm sieve. After 10 weeks the broodstock should be replaced, since the gametes are reabsorbed as a result of temperature stress and inadequate food supply.

6.3.2.2. Pacific oyster and Manila clam larvae

Broodstock acclimation systems consist of 150-200 l fibre glass tanks, each stocked with 50 broodstock animals of 20-25 g each. The broodstock tanks are continuously provided with preheated unfiltered natural seawater at a minimum rate of 1 l.min⁻¹. Algae (*Tetraselmis suecica*, *Skeletonema costatum* and *Thalassiosira pseudonana*) are continuously added to the seawater by means of a peristaltic pump. In the case of clams a substrate of sand and/or gravel can be used, but this is not essential. Under controlled temperature conditions gametogenesis and gamete maturation can be induced year round by submitting the bivalves to a sudden temperature shock (increasing the temperature 2 to 4°C). Spawning will take place within 15 min. and the gametes are released into the tank. During this period the water flow must be stopped in order to allow fertilization. A gentle aeration can be used to keep the gametes in suspension.

Monitoring during the development is necessary to estimate the time of harvesting of the trochophora larvae, which generally takes place after a few hours. The trochophores are harvested from the incubation suspension by pouring the content of the incubation tank on a submerged 35 µm sieve. After washing with pure preheated seawater the trochophora larvae can be fed to the fish or shrimp larval tanks.

6.3.3. Quality control of the produced trochophora larvae

Obtaining good quality trochophores with good swimming behaviour and a high nutritional value is important. Firstly, the broodstock must be fed with algae with a high nutritional value. Secondly, spawning must be synchronized, as there is rapid loss in sperm fertility. Thus, when males start spawning before the females, the males must be removed from the container and left out of the water, so as to stop the male spawning; the males are put back in the water when a sufficient number of females start to spawn. At no time should sperm older than 30 minutes be used.

To have a better control over the quality of the trochophores, one can divide the broodstock animals after the spawning shock over individual containers. After spawning is completed the females should be taken out so as to let the eggs settle on the bottom. Clumps of eggs must be separated to obtain good fertilization and this is achieved by pouring the content of the dishes or beakers through a 60 µm mesh screen and collecting the individual eggs on a 15 µm mesh sieve. The eggs are then washed with clear seawater, screened on their quality (eggs must hydrate within 10 min. in seawater and must have a uniformly dense, granular appearance), and pooled. Sperm from various males is pooled to ensure a good genetic mix in offspring. Fertilization is carried out by gently mixing 2 ml of a dense sperm suspension to 1 l of egg suspension, after which the suspension is allowed to stand for several hours. Within this period the fertilized eggs start to divide. However, densities of developing embryos should not exceed 80,000.l⁻¹.

6.3.4. Cryopreservation

Bivalve larvae can be cryopreserved at -196°C and used as live feed for later use. Cryopreservation has been successfully achieved with trochophora larvae of *Crassostrea gigas* and *Tapes philippinarum*. The larvae are equilibrated in a seawater solution of 2 M dimethylsulfoxide (DMSO) with 0.06 M trehalose (cryo-protectants) for 10 minutes at 25°C and are then sealed into polyethylene straws at a density of 15 and 50 million trochophores each. The straws are then rapidly cooled from room temperature to 0°C and then from 0°C to -12°C at a freezing rate of -1°C.min⁻¹. The straws are then held at -12°C for 5 to 15 minutes allowing equilibration of the temperature of the biomass. Finally, the trochophores are slowly cooled at -2°C.min⁻¹ to -35°C, after which they are allowed to equilibrate for 10 to 20 minutes before being submerged in liquid nitrogen (-196°C) (Chao *et al.*, 1995). Before use the

content of the straws is rapidly defrozen in a seawater bath at 28°C and after 1 h the actively swimming trochophores can be administered to the fish larvae. Cryopreserved trochophores are also commercially available as Trochofeed (Cryofeeds Ltd., Canada). They are produced from certified disease-free broodstock oysters of selected genetic strains.

6.4. Literature of interest

- Alam, J. 1992. *Moina micrura* (Kurz) as a live substitute for *Artemia* sp. in larval rearing of *Macrobrachium rosenbergii* (De Man), Doctoral thesis, Faculty of Fisheries and Marine Science, Universiti Pertanian Malaysia, 214 pp.
- Chao, N.-H., Lin, T.T., Chen, Y.-J. and Hsu, H.-W. 1995. Cryopreservation of late embryos and early larvae of oyster and hard clam. In: Larvi'95 - Fish & Shellfish Larviculture Symposium. Lavens, P., E. Jaspers and I. Roelandts (Eds.). European Aquaculture Society, Special Publication No. 24, Gent, Belgium, p 46.
- D'Agostino, A.S. and Provasoli, L. 1970. Diaxenic culture of *Daphnia magna* Strauss. Biological Bulletin, 139: 485-494.
- Davison, J. 1969. Activation of the ephippial egg of *Daphnia magna* for insecticide bioassay. J. Econ. Entom., 57: 821-825.
- De Pauw, N., Laureys, P. and Morales, J. 1981. Mass cultivation of *Daphnia magna* strauss on rice bran, Aquaculture, 25: 141-152.
- Mohney, L.L., Lightner, D.V., Williams, R.R. and Bauerlein, M. 1990. Bioencapsulation of therapeutic quantities of the antibacterial Romet-30 in nauplii of the brine shrimp *Artemia* and in the nematode *Panagrellus redivivus*. Journal of the World Aquaculture Society, 21(3): 186-188.
- Murphy, J. 1970. A general method for the monaxenic cultivation of the Daphnidae. Biological Bulletin, 139: 321-332.
- Norman, K. E. 1977. The spatial occurrence of the Cladoceran *Moina macrocopa* (Straus) in a kraft pulp mill treatment lagoon. University of Washington, Seattle, Washington 98195, USA, 15p.
- Rouse, D.B., Webster, C.D. and Radwin, I.A. 1992. Enhancement of the fatty acid composition of the nematode *Panagrellus redivivus* using three different media. Journal of the World Aquaculture Society, 23(1): 89-95.
- Utting, S.D. 1993. Procedures for the maintenance and hatchery-conditioning of bivalve broodstocks. World Aquaculture, 24(3): 78-82.
- Watanabe, T. and Kiron, V. 1994. Prospects in larval fish dietetics. Aquaculture, 124: 223-251.

The success of any farming operation for fish and shellfish depends upon the availability of a ready supply of larvae or "seed" for on-growing to market size. The cultivation of fish and shellfish larvae under controlled hatchery conditions requires not only the development of specific culture techniques, but in most cases also the production and use of live food organisms as feed for the developing larvae. The present manual reviews and summarizes the latest developments concerning the production and use of the major live food organisms currently employed in larviculture worldwide. It describes the main production techniques as well as their application potential in terms of their nutritional and physical properties and feeding methods. The manual is divided into sections according to the major groups of live food organisms used in aquaculture, namely micro-algae, rotifers, *Artemia*, natural zooplankton, and copepods, nematodes and trochophores. The document has been prepared to help meet the needs of aquaculture workers of member countries for the synthesis of information in the field of aquaculture nutrition and feed development.

ISBN 92-5-103934-8 ISSN 0429-9345



9 7 8 9 2 5 1 0 3 9 3 4 2

M-44

W3732E/1/12.96/2000